

**AUTOMATIC
FREQUENCY CONTROL SYSTEMS**

Other Books
by
JOHN F. RIDER

THE CATHODE-RAY TUBE AT WORK

ALIGNING PHILCO RECEIVERS

SERVICING SUPERHETERODYNES

PERPETUAL TROUBLE SHOOTER'S MANUAL

Volume I

Volume II

Volume III

Volume IV

Volume V

Volume VI

Volume VII

Volume VIII

Volume IX

**SERVICING RECEIVERS BY MEANS OF RESISTANCE
MEASUREMENT**

AN HOUR A DAY WITH RIDER

on

AUTOMATIC VOLUME CONTROL

RESONANCE AND ALIGNMENT

D-C. VOLTAGE DISTRIBUTION IN RADIO RECEIVERS

ALTERNATING CURRENTS IN RADIO RECEIVERS

AUTOMATIC FREQUENCY CONTROL SYSTEMS

BY

JOHN F. RIDER

Author of

*Perpetual Trouble Shooter's Manual, The Cathode-Ray Tube at Work,
Aligning Philco Receivers, The Hour a Day With Rider
Series, and other books for the Service Industry*

JOHN F. RIDER, Publisher

404 Fourth Avenue

New York City

Copyright 1937, by
JOHN F. RIDER

All rights reserved, including that of translation into the Scandinavian and other foreign languages

First Printing, October, 1937
Second Printing, November, 1937
Third Printing, December, 1938

Printed in the United States of America

DEDICATED TO
JANET
who has past her
fifth birthday

AUTHOR'S FOREWORD

THE addition of automatic frequency control to the superheterodyne has added just one more problem that the serviceman must solve. . . . In the main it is true that the functioning of all the AFC circuits has a common basis, i.e., a shifting of the frequency of the receiver's oscillator to compensate for inaccuracies in the setting of the tuning condenser, but as is usual in circuit design, the number of variations of the basic circuit is legion. It is the author's belief in this as in everything, that a complete understanding of the principles on which the AFC circuit is based is the only intelligent and logical way to attack the solution of the problem.

With this thought in mind the first four chapters are devoted to a description of basic principles. We have taken the liberty of including a review chapter covering certain phases of fundamental radio theory for those men in whose minds these very important principles are hazy and without which a thorough comprehension of the remainder of the book would be impossible. The rest of the chapters cover the different types of AFC circuits found in commercial receivers, the alignment, and general servicing notes of this latest radio development.

The introduction of AFC has enabled radio engineers to add semi-automatic and automatic systems of tuning to the superheterodyne and so the serviceman has to turn to things mechanical. While a complete description of the various methods of automatic tuning is beyond the scope of this book, one or two systems, which might be classified as basic, are described, with the thought that a more complete explanation may be had from the various manufacturers' service bulletins.

The author wishes to express his thanks to the several manufacturers who have cooperated with him in supplying data on the AFC systems incorporated in their receivers and for the photographs of their dials and sets used on the jacket.

JOHN F. RIDER.

September 23, 1937.

TABLE OF CONTENTS

- CHAPTER I. INTRODUCTION—1. Effects of Mistuning—2. What AFC Does—3. How AFC Operates—5.
- CHAPTER II. GENERAL REVIEW—8. D-C Voltages and Polarity—8. Inductance in A-C Circuits—11. Transformers—13. Secondary Circuit—15. Center-Tapped Winding—16. Capacity in A-C Circuits—17.
- CHAPTER III. THE DISCRIMINATOR—20. Output of a Simple Rectifier—20. The Double-Tuned Circuit Discriminator—22. Effect of Staggered Tuned Circuits—25. The "Center-Tapped Secondary" Discriminator—28. Breakdown of the Differential Rectifier Circuit—30. Importance of Phase Shift—32. I.F. at Correct Value—34. I.F. High—36. I.F. Low—39. Importance of Secondary Tuning—41. Discriminator without I-F Choke—42. The Westinghouse Discriminator—44. The Triple-Tuned Discriminator—49.
- CHAPTER IV. THE OSCILLATOR CONTROL CIRCUIT—53. Vacuum Tube Circuit as an Inductance—55.
- CHAPTER V. COMMERCIAL AFC CIRCUITS—63. AFC in G.E. Model E-101—64. The Control Tube—66. Crosley Model 1316—68. Separate I-F Channel for AFC—68. The Discriminator—69. The Voltage Limiting Diode—69. AFC in Double Superheterodynes—71. The Limiter Amplifier Stage—74. Midwest Model 18-37—76. G.E. Model FA-80—78. Grunow Models 12B, 12W—80. Grunow Model 15W—83. RCA Model 812K—84. "Electric Tuning" Circuit—87. The Push-Pull Discriminator and Control Circuit—93. Push-Pull AFC Using the Pentagrid Converter—98. Flash Tuning—100. Low-Frequency Discriminator System—102.

- CHAPTER VI. ALIGNING AFC CIRCUITS—106. Galvanometer Alignment of Primary and Secondary Trimmers—108. Galvanometer Sensitivity—111. The Vacuum-Tube Voltmeter Method—111. The Control-Tube Current Method—112. The Two-Signal Method—114. Alignment of Push-Pull Circuits—116. The Visual Alignment Method—117. Alignment of Iron-Core Discriminators—120. Radio-Frequency and Oscillator Alignment—120. Alignment of Commercial Receiver Circuits—121. Philco Models 37-9, 37-10, 37-11—121. Philco Models 37-116, 37-675, 37-690—122. Crosley Model 1316—123. Sears-Roebuck Receivers—124. Westinghouse Model WR-315—125. Determination of Primary and Secondary Discriminator Trimmers—125. Alignment Precautions—126. Setting-up AFC Stations—127. Setting-up Stations 10 kc Apart—129. Performance of Circuit—131. Aligning with the Rider Chanalyst—142.
- CHAPTER VII. SERVICING AFC SYSTEMS—132. Checking the Discriminator—134. Checking the Control-Tube Circuit—134. Improper Operation of Oscillator—135. Hum—136. Time Constant—137. Secondary Trimmer—138. Loss of Signal Control—139. Motorboating—140. Dial Switch—141.

**AUTOMATIC
FREQUENCY CONTROL SYSTEMS**

CHAPTER I

INTRODUCTION

THE tuning process has always been one of the most important in the operation of a radio receiver, permitting, as it does, the selection of any one of a number of different channels to which the receiver will respond. Realizing the importance of this control, much research has been directed toward finding methods for effecting a simplification and improvement in tuning. Automatic frequency control, the subject of this book, is the latest step in the long chain of developments which has marked the fruits of this research.

Prior to automatic frequency control, we witnessed the evolution of the modern receiver from the cumbersome instrument of ten years ago, which in many cases had as many as five or more separate tuning controls. Ganging of these individual tuning controls marked a real forward advance in the simplification of tuning, and up to the introduction of the superheterodyne it might well be said that the tuning problem was pretty well solved.

However, the widespread development and use of the superheterodyne brought with it new problems because of the increased selectivity which this circuit made possible. It is true that improved vernier dial mechanisms did make for smoother tuning and that tuning indicators were of great assistance in making possible more accurate tuning, but in spite of these aids, there is no question but that the present-day superheterodyne which is not equipped with automatic frequency control requires more care in accurately tuning in a signal than the average set user is generally willing or able to employ.

Effects of Mistuning.

Suppose that a receiver is not tuned exactly to a signal which is being received, what then? As far as the volume output of the receiver is concerned, the set operator will always adjust the volume control so that the output of the receiver is at the desired level. But unfortunately inaccuracies in tuning cannot be compensated for by changes in the setting of the volume control, since the effect of mistuning is to introduce serious distortion into the audio output,—the amount of distortion depending upon the degree of mistuning. Thus, when the receiver is only slightly detuned, the higher audio frequencies are increased because the higher side frequencies of one sideband are brought within the resonance curve. For greater degrees of mistuning, distortion is introduced as a result of the partial suppression of the carrier. In addition, the change in the phase relations between the carrier and the sidebands also gives rise to further distortion. The oscillograms in Figs. 1 and 2 illustrate how serious this distortion can be.

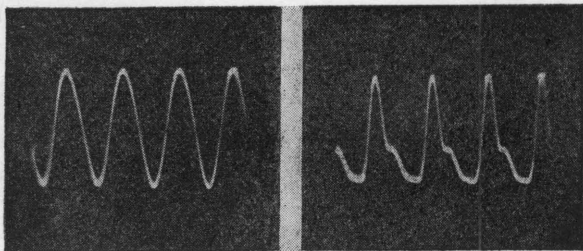

Fig. 1, left, Fig. 2. When a receiver is correctly tuned to a signal (in this case the modulation is a sine wave), the output will be undistorted, as the oscillogram of Fig. 1 shows. If the set is inaccurately tuned, a distorted output will result as shown in Fig. 2

The public in general has come to expect a greater amount of fidelity in the reception of radio programs and a great deal of money is being spent on the installation of high-fidelity transmitting equipment; consequently such distortion as a

result of inaccurate tuning is of considerable importance. In high-fidelity receivers which have a flat top band-pass characteristic and automatic volume control, tuning is even more complicated, because the output level remains substantially flat for a considerable range on either side of the correct tuning position. While it is true that this problem has been partially solved by the use of increased selectivity in the tuning indicator circuit, nevertheless the fact remains that it is most important that these high-fidelity receivers be accurately tuned.

On the short-wave bands, where tuning is extremely sharp as a result of the inherent selectivity of the superheterodyne receiver, it is equally important that the receiver be tuned accurately to the signal. Here, however, the problem is not so difficult since the receiver *must* be tuned rather carefully if the signal is to be received at all. Nevertheless we shall see later on in this book that automatic frequency control is of great value on the short-wave bands as well as on the broadcast band, because it helps to overcome the effects of oscillator drift. In this respect it removes the necessity for continually readjusting the tuning control as the receiver warms up and the oscillator circuits reach a stable operating condition.

What Automatic Frequency Control Does.

We have indicated in the preceding paragraphs the reasons why it is desirable that a receiver be accurately tuned to the signal which is being received. The circuit development known as automatic frequency control and which is to be designated throughout this book by the letters AFC, is a system for accurately tuning in a station with the least amount of effort on the part of the set operator. In other words, a receiver equipped with AFC need not be tuned with the same care and accuracy as a receiver without AFC; in fact, the AFC-equipped receiver will be tuned more accurately than a receiver not so equipped is normally tuned, even though the manual setting of the gang condenser is off by as much as several kilocycles. Explained in a slightly different way, AFC compensates for errors made in selecting a desired station manually and within limits of the order of 10 kc on

4 AUTOMATIC FREQUENCY CONTROL SYSTEMS

either side of the carrier, the signal will be received with perfect fidelity.

The ease and simplification in tuning which AFC makes possible is graphically shown in Figs. 3 and 4. For the sake of clarity we take the case in which it is desired to receive a station operating on a carrier frequency of 800 kc. Fig. 3 shows the great care in tuning which must be exercised if the receiver is not equipped with AFC. If the limits indicated by the shaded area, which extends from 798 to 802 kc are exceeded, then a noticeable amount of distortion will be introduced into the output. This admittedly calls for more care in tuning than the average set owner takes.

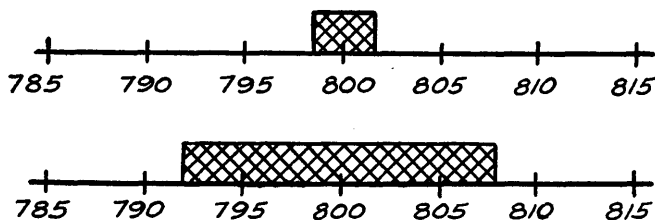

Fig. 3, above, Fig. 4. For distortionless reception, the dial pointer must be set within the limits of the shaded area of Fig. 3, the carrier frequency of the station being 800 kc. Fig. 4 shows how AFC extends the limits within which perfect reception is possible

The great improvement which is brought about by the introduction of AFC is shown in Fig. 4. Note that the receiver will now be in perfect tune as long as the dial pointer lies within the greatly extended shaded area. The diagram shows this area extending over a range of 8 kc on either side of the carrier, which can be taken as typical of the performance of receivers equipped with AFC. The incorporation of AFC thus makes it possible to tune a receiver quickly to the approximate location of the desired station and still to have the receiver in perfect tune despite the fact that the setting does not coincide exactly with the dial reading in question. Obviously it is hardly necessary to rock the dial back and forth while watching a tuning indicator in order to set the pointer within the limits shown in Fig. 4. On the contrary, the tolerance is sufficiently great so that it is even

possible to use a control system resembling a telephone dial, whereby exact tuning is accomplished by inserting the finger in the appropriate hole and flicking the dial to the stop. Even where the conventional dial arrangement is used, AFC effects a great saving in time by making it possible to have the station tuned in accurately at the first trial without a supplementary fine readjustment.

Perhaps we have created the impression that just because a receiver is equipped with AFC it is permissible to tune it carelessly without limit. Such is not the case. While no distortion will be introduced if a receiver is tuned within the limits shown in Fig. 4, for reasons which will be explained later on it is desirable that the receiver be tuned with a fair amount of care and that *large* errors in tuning be avoided.

It should be mentioned here that AFC is not to be confused with remote control and automatic systems of tuning which employ a motor and suitable controls to rotate the shaft of the tuning condenser to the proper position. While AFC does simplify the design of such systems in that it reduces the tolerance required in the setting of the condenser shaft, you should keep in mind that it is a basically new system and functions apart and independently of the automatic tuning mechanism. You must understand that AFC does not mechanically tune the receiver by rotating the condenser gang.

How Automatic Frequency Control Operates.

We stated that AFC makes possible quick and accurate tuning, eliminates distortion as a result of inaccurate tuning, and prevents variation in the output signal as a result of drift in the oscillator frequency. To explain exactly how this is accomplished in all its many details is of course the function of this book. However, we believe that it will be of value in this opening chapter to give you a bird's-eye view of how the entire system operates. This will better enable you to see in its proper perspective the relation between the various parts and the system considered as a whole. Having obtained this view of the general method of operation, you will better be able to follow the detailed explanation of how the various elements in the system function.

6 AUTOMATIC FREQUENCY CONTROL SYSTEMS

The block diagram in Fig. 5 shows the path which a signal takes in passing from the antenna to the speaker of a conventional superheterodyne. As a result of the fact that the receiver is equipped with AFC, two new units are used in the receiver and these are called the *discriminator* and the *oscillator control* stages. They are indicated in the diagram in heavy lines so as to distinguish them from the other components which are not directly related to the AFC system.

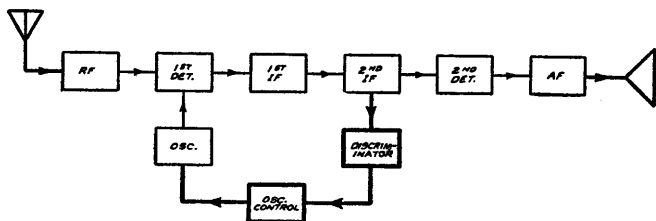

Fig. 5. The block diagram shows how the discriminator and oscillator control circuits are added to a superheterodyne to obtain AFC action

Before you can follow the operation of this general AFC system, it is absolutely essential to understand that whether or not a superheterodyne receiver is correctly tuned depends almost entirely upon the value of the oscillator frequency. That is, when the oscillator frequency is higher than the signal frequency by an amount equal to the intermediate frequency, the receiver is tuned correctly. In the same way, if the oscillator frequency is either higher or lower than this value, then the receiver is mistuned and distortion will result.

Because of the dependence of tuning upon the oscillator frequency, every system of automatic frequency control incorporates a unit which automatically maintains the oscillator frequency at the correct value. This is the function of the oscillator control stage in Fig. 5.

Since we are dealing with an automatic system, there must be some element in the system which automatically flashes a "signal" to the oscillator control stage so as to tell this stage whether the oscillator frequency is correct, and if not, how far off it is, and in what direction this deviation is. The unit designated as the *discriminator* performs this function.

In Chapter III we shall investigate in detail how the various types of discriminators operate. For the time being, it will suffice to state that the discriminator operates by means of a voltage which it produces in accordance with whether the signal comes through the i-f amplifier at the i-f peak or at some frequency different from the i-f peak. If the receiver is tuned correctly, the signal comes through at the i-f peak and zero control voltage is produced in the discriminator. However, if the signal comes through on one side of the i-f peak, then a **negative** control voltage is produced, and if the signal comes through on the other side of the i-f peak, then a **positive** control voltage is produced. The particular polarity required depends on the control circuit used.

As you will observe from the connection of the discriminator in the block diagram, this control voltage which is produced by the discriminator is applied to the oscillator control stage. As a result of the manner in which the oscillator control stage is arranged, the application of this control voltage changes the oscillator frequency to the correct value and in this way corrects any inaccuracies in tuning which may have been present.

It is hardly to be expected that you will understand how AFC operates from this rather sketchy explanation. However, it should serve as a background for the detailed explanations of discriminator and oscillator control circuits which we shall present in subsequent chapters of this book.

CHAPTER II

GENERAL REVIEW

IN VIEW of the fact that this book is intended for servicemen and experimenters, we feel it necessary to consider briefly a number of basic subjects of importance in connection with the operation of AFC circuits. As far as the review in this chapter is concerned, it will be as brief as is consistent with a clear presentation. Those who are familiar with the subjects discussed can naturally omit this chapter, but those men who do not thoroughly understand such subjects as relative polarity in d-c circuits and the phase relations in inductances, condensers, and transformers,—should read this chapter thoroughly—perhaps even twice.

As to the elementary concept of phase, we are going to take for granted that the reader has an idea of what phase means. We take this viewpoint because of the fact that the author has written a volume entitled "An Hour a Day with Rider on Alternating Currents in Radio Receivers," wherein the subject of phase is discussed in great detail, and which book has already been offered to those men to whom this book on AFC is addressed.

D-C Voltages and Polarity.

There are a number of ways in which d-c voltages—no matter what their source—can be arranged so as to develop a resultant voltage between two points. One such method is to connect the two voltages in such manner that both tend to drive current through the circuit in the same direction. When this is done, the two voltages are connected in series, as shown in Fig. 6. If we designate one voltage as E_1 and

the other as E2, the resultant voltage E3 will be the sum of the two voltages in the series combination. If E1, for example, is 10 volts and E2 is 10 volts, E3 will equal 20 volts. Of course these figures are purely illustrative and the relation holds true irrespective of the numerical values of E1 and E2. As to the polarity of the resultant voltage, it is the same as the polarity of either one of the voltages connected in series.

Fig. 6. When the positive side of one voltage E1 is connected to the negative side of another E2, the resultant voltage E3 is the sum

Fig. 7. When the positive sides of two equal voltages are connected, the resultant voltage E3 is zero, that is, they cancel out

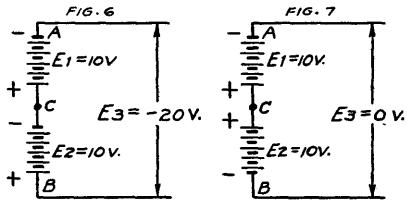

Another type of connection is shown in Fig. 7, wherein the two voltages E1 and E2 are so connected that the positive terminal of E1 joins the positive terminal of E2. In this arrangement, each of the voltages tends to send current through the circuit in different directions, so that the two voltages tend to buck or offset each other. In such cases, the resultant voltage E3 is equal to the difference between the two voltages, E1 and E2. If E1 is 10 volts and E2 is 10 volts, the resultant voltage E3 is equal to zero, because the

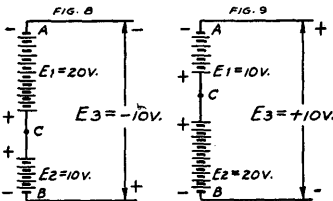

Figs. 8 and 9. When the positive sides of two unequal voltages are connected, the resultant voltage equals the difference between the two, and its polarity is the same as the polarity of the larger voltage

two voltages, acting in opposite directions, cancel each other.

However, if E1 is 20 volts and E2 is 10 volts, as shown in Fig. 8, the resultant voltage E3 is 10 volts, being the difference between E1 and E2. As to the polarity of the resultant voltage, it is determined by the polarity of the greater of the

two voltages, so that point A becomes 10 volts negative with respect to point B. As is evident, the circuit assumes the polarity of the greater of the two voltages, or E_1 .

If we now reverse the values, as shown in Fig. 9, so that E_1 is 10 volts and E_2 is 20 volts, the resultant voltage E_3 again is 10 volts, but now the polarity of this voltage is determined by the polarity of E_2 , because it is this voltage which is the greater of the two voltages in the combination. In this case point B becomes the negative terminal with respect to all other points in the circuit, and point A is 10 volts positive with respect to point B.

You can therefore see that polarity is purely a relative term and depends entirely upon the polarity and magnitude of the individual voltages in the circuit.

If we replace the batteries of Figs. 7, 8 and 9 with a resistance network, such as shown in Fig. 10, and assume that

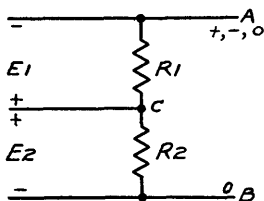

Fig. 10. The voltage at point A with respect to B can be positive, negative, or zero, depending upon the relative values of the voltage drops across the resistors R_1 and R_2

a d-c voltage E_1 is developed across R_1 and a d-c voltage E_2 is developed across R_2 , we have the equivalent of what was shown in Figs. 7, 8 and 9. If A and B are the two limits of this resistor network, we can see how it is possible for A and B to be the same potential ($E_1 = E_2$), or for point A to be positive or negative with respect to point B. It all depends upon the relative values of E_1 and E_2 .

Such a voltage system with variable polarity is to be found in AFC circuits in what is known as the *differentially connected rectifier* employed in discriminator circuits. In this circuit, which will be described in the following chapter, the two d-c voltages E_1 and E_2 are secured from diode rectifiers and appear across two load resistors similar to R_1 and R_2 Let us now move on to another topic of interest.

Inductance in A-C Circuits.

When an inductance is used in an a-c circuit, a number of interesting actions occur which are of considerable importance in connection with the operation of AFC circuits. . . . In order to present an explanation of how these various actions occur, let us consider first the behavior of an inductance or coil when a d-c voltage is applied. Accordingly, we arrange the circuit shown in Fig. 11, wherein a coil L is connected

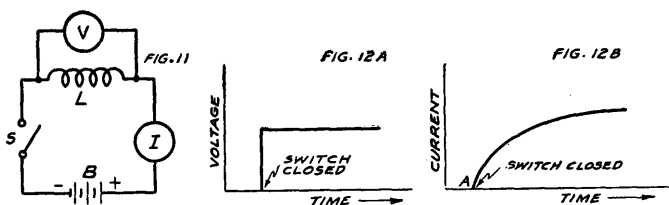

Fig. 11. The ammeter I indicates the current flowing in the series circuit, consisting of a coil, battery, and switch, while the voltmeter V shows the voltage across the coil L . When the switch S is closed, the voltage rises at once to its maximum value, Fig. 12A, but the current rises slowly to its maximum value, Fig. 12B, and thus lags behind the voltage

across a battery B . The voltmeter V measures the voltage appearing across the coil and the ammeter I shows the current flowing through the circuit. The switch S opens or closes the circuit.

What happens when the switch S is closed? . . . The voltmeter V instantaneously indicates the voltage of the battery, but strange as it may seem, the ammeter I does not indicate the maximum current at the first instant. . . . Instead, it shows a small value of current, which gradually rises to the maximum value determined by the d-c resistance of the circuit—and then remains constant at this value as long as the voltage is applied. . . . In other words, the current rise *lags* behind the voltage. If we illustrate graphically what has been described, the condition would be as shown in Figs. 12 A and B. Something associated with the inductance prevents the current from rising to a maximum simultaneously with

the voltage, as it would in the case of a circuit containing only resistance. . . . This phenomenon of current lagging behind voltage is characteristic of inductances and is always associated with them. . . . If the battery B in Fig. 11 were replaced by a source of varying voltage, we would find that the current rise would always follow behind the voltage rise—and the current fall or decrease would always occur after the decrease in the applied voltage. . . . Let us see why. . . .

The current-lagging action which we have just described depends upon two basic laws. One of these states that when an electrical current flows through a conductor, magnetic lines of force are created and surround the conductor. The second important electrical law states that when varying magnetic lines of force cut a conductor, a voltage or electromotive force (emf) is induced in that conductor. Applying these two principles to the circuit of Fig. 11, we see first of all that because of the current flow, magnetic lines of force surround the turns of coil L. . . . At the start—that is, the moment after the switch S is closed—the current starts increasing and the magnetic lines of force are varying in strength. . . . Therefore, in accordance with the second law, these magnetic lines of force cut the turns and induce in them a new voltage.

This new voltage is known as the *self-induced voltage*, or *counter emf*. It has this important property, namely, its direction or action is always such as to oppose any change in the value of the current already existing. In the case of the circuit shown in Fig. 11, the current does not immediately rise to its final value because the counter emf tends to oppose the change in the initial value of the current. Since the initial value of the current is zero, the current tends to remain at this value, and is prevented from increasing rapidly to its final value.

A similar situation exists in the case of an inductance which is placed in an alternating current circuit. If we represent the applied voltage by E_a , the counter emf or induced voltage by E_i , and the current by I , then it turns out that these

quantities can be represented as shown in Fig. 13. Let us see why this is so. . . .

In the first place the counter emf, E_i , will always be in such a direction as to oppose the change in current and hence will always be opposite in phase to E_a . Thus E_i is represented as being 180° out of phase with E_a . On the other hand, as

Fig. 13. In an a-c circuit containing inductance, the counter emf E_i is 180° out of phase with the applied voltage, E_a . The current I lags 90° behind E_a

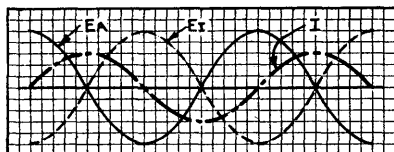

in the case of the d-c circuit, the current does not reach its final peak value until after the applied voltage, and in fact, lags one quarter cycle or 90° behind the applied voltage. Thus the current I is shown as lagging 90° behind E_a in Fig. 13.

In this illustration we have assumed that no resistance is present in the circuit. In any actual case, however, some resistance is of course present in the circuit, even if it is limited only to that possessed by the coil, and its effect is to change the phase of the current so that it lags the applied voltage by less than 90 degrees. The greater the value of resistance, the smaller is the amount by which the current lags the voltage. . . . So much for current-voltage relations in an inductance.

Transformers.

The transformer is of interest to us in this book because it appears as an essential component in most AFC discriminator circuits and in some types of control circuits. While we do not intend to go into a very detailed analysis of the transformer, we do feel that a brief description of the various current and voltage relations which exist in transformer circuits will be of assistance in aiding the understanding of AFC circuits.

14 AUTOMATIC FREQUENCY CONTROL SYSTEMS

The circuit of Fig. 14 shows the simplest possible type of transformer consisting of two windings which are placed close to each other. The primary winding is connected to an alternating-current generator which is indicated in the illustration as producing the voltage E_p . If we disregard the

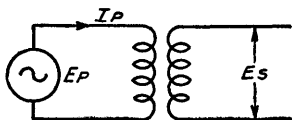

Fig. 14. The phase relations in this simple transformer circuit are explained in the text. The primary voltage and current are E_p and I_p respectively and the secondary voltage is E_s

secondary winding for the time being, then the primary circuit consists of an inductance in series with an alternating-current generator. From a previous study of the action of an inductance when it is connected to an alternating-current circuit, you can readily understand that the primary current I_p will flow through the primary winding and that this current will lag the applied voltage E_p by approximately 90° .

Furthermore, in accordance with what has been said concerning the action of current flowing through an inductance, this primary current I_p sets up a magnetic field or magnetic flux and this magnetic flux is in phase with the current producing it. It also induces a counter emf across the primary and this counter voltage is 180° out of phase with the applied voltage E_p . Since the magnetic flux produced by the current is in phase with the current and since the current lags 90° behind the applied voltage, it stands to reason that the magnetic flux likewise lags the primary voltage by 90° . So far we have neglected the presence of the secondary circuit since it is not completed and therefore no current can flow in it.

Even though it is quite true that the secondary winding draws no current, nevertheless, a voltage is induced in this winding. This induced voltage is due to the presence of the changing magnetic flux created by the primary current. In the same way that this changing flux causes a counter voltage to be induced in the primary, so this same flux, when cutting the secondary winding, induces a voltage in this winding. Since both the primary counter emf and the voltage induced

in the secondary are due to the same magnetic field, it follows that the voltage induced in the secondary will be in phase with the counter voltage induced in the primary. . . . Now, since the counter emf in the primary is 180° out of phase with the applied primary voltage E_p , the secondary voltage will therefore also be 180° out of phase with E_p .

As far as the elementary explanation of the operation of transformers is concerned, it makes no difference whether an air core or an iron core is used. When an iron core is used, then the number of magnetic flux lines which reach the secondary coil will be considerably greater than in the case of the air core. This is so because the iron core provides a better path than does air for these lines of force.

Most discriminator transformers used in AFC systems which we shall have occasion to discuss, make use of air-core transformers. However, at least one manufacturer is employing an iron-core discriminator transformer at the time of this writing and more than likely such transformers will be used by other manufacturers in the future.

Secondary Circuit.

So far we have discussed a simple case wherein the secondary circuit of a typical transformer is incomplete, and we have made brief reference to the voltage which is induced in the

Fig. 15. A simple transformer circuit in which the secondary circuit is completed through a resistor R , so that a secondary current I_s flows. The phase relation of I_s depends on several factors

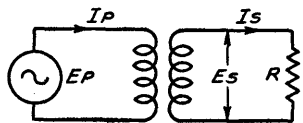

secondary winding. Let us now suppose that the secondary circuit is completed as we have shown in Fig. 15. First of all, we know that an induced voltage exists across the secondary winding. Second, current will naturally flow in the secondary circuit—because current flows in every closed circuit when a voltage is impressed. As to the phase of the secondary current I_s , it is only natural that it will be in accordance with the general behavior of inductive circuits; in other words, the secondary current I_s will lag behind the secondary voltage E_s . The exact amount by which the secondary current lags

behind the secondary induced voltage depends upon the relative values of the secondary reactance and the resistance R . If R is comparatively small, then the phase lag of the current will be approximately 90° , while if R is comparatively large, then the phase lag will be correspondingly less than 90° .

Center-tapped Winding.

Let us now consider a slightly different type of transformer—one in which the secondary circuit consists of a winding with a center-tap. Examples of transformers of this type are the conventional push-pull input transformer and the conventional power transformer, provided we disregard the filament windings and consider only the high-voltage plate winding intended for use in a full-wave rectifier. In the next chapter you will readily see the similarity between this type of winding with respect to the voltages present in the circuit and the type of transformer system employed in AFC discriminators. The type of transformer we have under consideration is shown in Fig. 16.

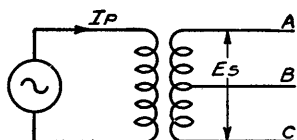

Fig. 16. The voltages at the ends of the center-tapped secondary are opposite in polarity with respect to the center-tap and are 180° out of phase with each other

The voltage E_p is applied across the primary, and the secondary voltage E_s appears across the entire secondary winding or between the terminals A and C. What is the effect of the mid-tap B? Assuming that this tap is located at the electrical center of the secondary winding, then the total voltage E_s is divided between the two halves of the winding—or between A-B and B-C. The induced voltage naturally appears across the entire winding—or all of the turns—hence, half of the voltage will be present across each half of the winding.

If for the present we neglect the primary and consider the secondary alone, we find that when one end A of the secondary is positive, the other end C of the secondary is negative and vice versa. . . . In other words, the voltages at the two

ends of the winding are 180° out of phase. Now, when point A is positive, it is with respect to the center-tap B and when C is negative, it is also with respect to B. In other words, the center-tap B can be said to be of neutral polarity and the two ends change in polarity around the center-tap B. The net result is that the voltage present across the top half of the winding is 180° out of phase with the voltage across the bottom half of the secondary winding. As you will see later, this is an important consideration in the operation of discriminator circuits.

Capacity in A-C Circuits.

We have seen how in an inductive circuit, the current lags the impressed voltage by 90° . In the case of capacitive circuits, the current *leads* the voltage by 90° . While we do not intend to go into the subject in a quantitative manner, it will,

Fig. 17. An a-c generator E connected in series with a condenser C. The current is designated as I

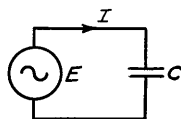

nevertheless, be instructive to consider briefly the relation between the voltage and current when a condenser is used in an a-c circuit.

Suppose, then, that we consider a simple circuit; see Fig. 17. A sine-wave alternating voltage E is applied to the condenser C. As a result of the nature of the applied voltage, the condenser will be charged alternately positive and negative. If we plot the charge on the plates of the condenser, the representation will be a sine wave since the voltage applied is sine. In other words, the instant the voltage is greatest in the negative direction—the charge on the condenser is greatest in the negative direction. . . . The instant that the voltage is greatest in the positive direction—the charge on the condenser is also greatest in the positive direction. In other words, the charge and the voltage have the same phase.

Now, if we bear in mind that the flow of current in a circuit depends upon the rate of movement of electric charges

(electrons) in the circuit, then it is quite simple to determine the phase relation between the current and the charge on the condenser. In Fig. 18 we show a sine-wave curve illustrating the charge on the condenser. From this curve we can establish the variation of the current in the circuit.

At point 1 in Fig. 18 the charge is greatest and negative, and for the instant is not moving—consequently, the current is zero and this corresponds to point 1 in Fig. 19. At point 2 in Fig. 18, the charge is passing through the zero point and

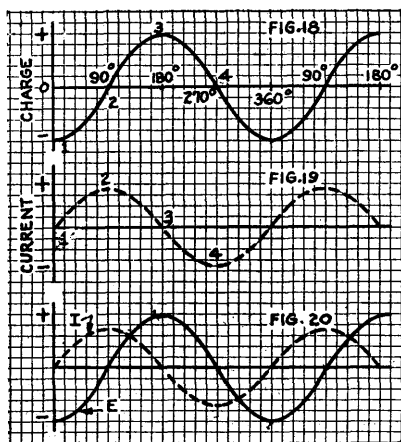

The charge on C in Fig. 17 follows the sine-wave variation of the voltage, see Fig. 18: the positive and negative peaks of charge occur at the same instant as the voltage peaks. The current in Fig. 17 follows a sine-wave variation, but its zero values occur when the charge goes through its peak values as shown Fig. 19. In Fig. 20 both voltage and current waves are plotted on the same axis, showing that the current I leads the voltage E by one-quarter cycle, or 90°

therefore is moving at the greatest rate of speed—which means that the current is greatest—and this corresponds to point 2 in Fig. 19. At point 3 in Fig. 18 the charge again is a maximum—this time in the positive direction, and again momentarily at rest—hence, the current is again zero. This is indicated as point 3 in Fig. 19. At point 4 in Fig. 18 the charge is again moving at the fastest rate because it is passing through the zero point—hence, the current again has a peak value, as indicated by point 4 in Fig. 19. This relation continues as long as the voltage E (Fig. 17) is applied to the condenser C.

If we show the relation between the current and voltage upon the same time axis—bearing in mind, as previously

stated, that the charge and the voltage are similarly identified—the two curves appear as illustrated in Fig. 20. As is evident, the current passes through its zero value after having reached a maximum on the positive side, one-quarter cycle or 90° ahead of the voltage; consequently, we can say that the current leads the voltage by one-quarter cycle or 90° .

In the chapters which follow, use is made of the fact that the current through a condenser leads the voltage applied to the condenser. It might be well at this time to mention that we are not concerned with the actual magnitude of the current as illustrated in Figs. 19 and 20. We are interested primarily in the phase relation between the current and the voltage.

With these few words we bring this review to a close. We of course realize that the various subjects dealt with are not covered in the fullest detail, but we are of the opinion that sufficient has been said to enable you to employ this review chapter in connection with what will follow in the remainder of this book. In the event that these review details are not sufficiently elaborate, you have recourse to any number of excellent text books devoted to basic circuit fundamentals, but we believe that you will find such further reference unnecessary.

CHAPTER III

THE DISCRIMINATOR

WE STATED earlier in this book that an AFC system consists primarily of two major component circuits: the discriminator and the oscillator control stage. We further stated that the function of the discriminator is to develop a control voltage of varying magnitude and polarity, in accordance with the degree of mistuning; this control voltage is applied to the oscillator control stage so as to correct for mistuning and establish the proper operating conditions. Since the oscillator control stage is the subject for another chapter, let us now consider the operation of the discriminator unit.

Output of a Simple Rectifier.

Inasmuch as the discriminator in an AFC system is essentially a rectifier circuit, let us examine the d-c voltage produced by a simple rectifier which receives its voltage through a tuned circuit. Consider then the circuit shown in Fig. 21, wherein an ordinary i-f transformer is coupled to a diode rectifier. If the frequency to which the transformer is tuned is 465 kc and the input frequency is varied from, say, 455 kc to 475 kc, the rectified voltage (output) produced across the diode load resistor R1 will vary as the result of the change in the signal input voltage. . . . Because of the selective properties of the primary and secondary windings of the transformer T, the greatest output voltage will be produced when the frequency of the input signal is the same as the frequency to which the transformer is tuned, namely, 465

kc. Naturally this is also the frequency at which the input voltage to the rectifier is a maximum. If the input frequency (this corresponds to the i-f signal) is varied on either side of 465 kc, the value of d-c voltage output produced falls off and if we plot the rectified output voltage against the input frequency, we obtain the familiar resonance curve shown in Fig. 22.

Let us examine this resonance curve from the point of view of determining whether the d-c voltage produced in this circuit is suitable for actuating an oscillator control stage. At the present time we know very little, if anything, concerning this oscillator control stage, so that while the term is men-

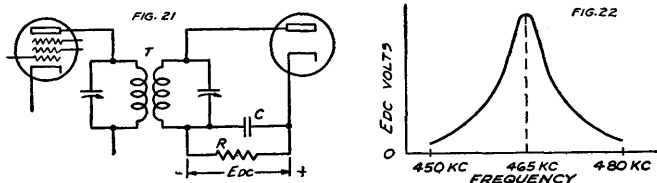

Figs. 21, 22. In the simple tuned rectifier circuit of Fig. 21, the d-c voltage E_{dc} developed across the diode load R is greatest at the resonant frequency of the tuned circuit, in this case 465 kc. The curve of Fig. 22 shows how E_{dc} falls off on both sides of the resonant frequency

tioned, we are concerned primarily with the nature of this rectified voltage. In this connection, we are interested especially in the polarity and magnitude of this voltage under varying conditions of input frequency. Referring to the curve, in Fig. 22, we note that a simple circuit of this type makes no distinction between frequencies which are above or below the resonant frequency by equal amounts. If we apply this illustration to the case in which the circuit is fed by an i-f amplifier, the polarity of the output voltage E_{dc} of the rectifier remains the same regardless of whether the i-f signal is above, below, or at the i-f peak of the receiver. Consequently the circuit of Fig. 21 is not suited for controlling the oscillator frequency.

22 AUTOMATIC FREQUENCY CONTROL SYSTEMS

As a matter of fact, by tuning the transformer in Fig. 21 to a frequency below or above the i-f peak, this circuit *can* be used to provide an AFC control voltage. For in this case, only one sloping side of the resonance curve is used with the result that a suitable control voltage is produced. This type of discriminator is not used because the value of control voltage produced when the receiver is correctly tuned depends upon the strength of the signal. Such a condition is, of course, undesirable, because the frequency of the oscillator would in turn be made dependent upon the strength of the signal being received.

The Double Tuned Circuit Discriminator.

How can we arrange a rectifier system which will develop rectified voltages of different polarity under the conditions named? A discriminator circuit which overcomes the difficulty experienced with the simple rectifier is shown in Fig. 23. This circuit, unlike that in Fig. 21, makes use of *two*

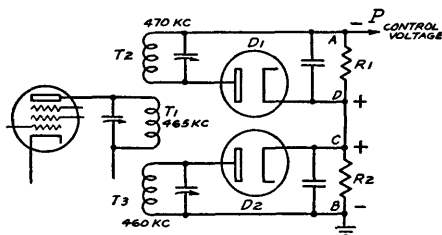

Fig. 23. This discriminator circuit has two staggered tuned circuits, one peaked above and one below the i-f peak by the same amount. The diode circuits are arranged so that the rectified voltages across R1 and R2 oppose each other

tuned input circuits, one of which is tuned to a frequency *above* the i-f peak and the other of which is tuned to a frequency *below* the i-f peak by the same amount. These two tuned circuits T2 and T3 are coupled to the primary tuned circuit T1 which, as the figure indicates, is located symmetrically between the two secondary windings. How does the introduction of these two tuned circuits provide a means of discriminating between frequencies which are below the i-f peak and those which are above the i-f peak? Let us see.

The first pertinent item to note is the manner in which the two diodes are connected. Note that each diode has its own input winding and that each diode is independent of the other. That is to say, each diode is a complete rectifying system by itself. Another significant fact is that the two diodes are so connected that when a d-c voltage appears

across R1 and another voltage across R2, as a result of rectifications, these two voltages are of such polarity as to buck each other. This becomes evident when you realize that the two cathodes represent the limits of the load circuits and that the two positive ends of the load resistors are joined together.

Assuming the application of a signal voltage to each of the diodes, let us investigate what happens across the two load resistors. If the signal voltage applied to the two diodes is the same in magnitude, then similar values of rectified voltage will appear across R1 and R2. Being connected so that the two voltages buck each other, the net voltage across the complete circuit is zero, and point P is at the same potential as ground. (Note that this conforms with the arrangement shown in Fig. 7 in the preceding chapter.)

Now, let us suppose that as a result of the amplitude of the signal voltage applied to the two tuned circuits, the voltage across R1 is 20 volts and that across R2 is 8 volts, both figures being purely illustrative. Just how and why such a variation is created in the input system so that this difference in output rectified voltages exists, is of no consequence at this time. All we are concerned with is the voltage across the diode load resistors. In accordance with what was said in connection with Figs. 8 and 9, a differential voltage of 12 volts then exists between ground and point P, with the latter 12 volts negative with respect to ground.

Let us now assume a different condition. As the consequence of the signal input to the diodes, the rectified d-c voltage across R1 is assumed to be 8 volts and that across R2, 20 volts. . . . (This is similar to the condition shown in connection with Fig. 9.) Because of the relative values and polarities, the net voltage again is 12 volts, but this time, the final voltage at P is *positive* with respect to ground. . . . In this case the final voltage assumes the polarity of the voltage across R2, because the latter is the greater of the two voltages which are combined. . . . What have we now? . . . Essentially, a means of securing d-c control voltages of a polarity which depends upon the relative amplitudes of the signal voltages applied to two differentially connected diodes.

24 AUTOMATIC FREQUENCY CONTROL SYSTEMS

To analyze the action which takes place in this circuit in a more detailed manner we shall take the specific case in which this discriminator is coupled to the i-f amplifier of a receiver peaked at 465 kc. Furthermore, we shall assume that the upper secondary winding is tuned to 470 kc, while the lower secondary winding is tuned to 460 kc. In other words, the two secondary circuits are tuned respectively 5 kc above and below the i-f peak. It will simplify matters if we sketch roughly the frequency response of the two secondary windings. This is done in Fig. 24. Naturally enough, the maximum voltage is induced in the upper tuned circuit when the signal frequency coming through the i-f amplifier is 470 kc, while the maximum voltage is induced in the lower tuned circuit when the signal frequency is 460 kc. On either side of the two resonant frequencies the voltage across the two secondary circuits falls off, as the figure shows. Thus we have the variation in input signal voltages which is required to produce the different values of rectified output voltage.

Continuing, we find that the rectified voltage produced across the diode load resistors follows the same variation as the i-f voltage across the two tuned circuits. However, because of the differential manner in which the circuit is connected in Fig. 23, the voltages are opposite in polarity and, as has been stated, the net voltage produced at the high end of R1 (point P) with respect to ground is equal to the difference between the voltage across R1 and that across R2.

In view of the fact that the voltages across R1 and R2 are opposite in sign, we can represent the individual voltages produced across R1 and R2 by the two curves shown in Fig. 25. For any given frequency which is represented along the horizontal axis, the corresponding d-c voltage produced across R2 is represented by the solid-line curve, while the d-c voltage developed across R1 is represented by the dotted-line curve. The former is shown above the axis because the voltage across R2 is positive, while that across R1 is negative and is shown below the horizontal axis.

But we are interested in the net voltage with respect to ground which is produced across R1 and R2 combined. This

voltage we can find very simply by taking the sum of the two individual voltages of Fig. 25. In other words if we wish to find the voltage between point P and ground (Fig. 23) for any one value of input frequency, then it is only necessary to combine the voltages which exist across R1 and

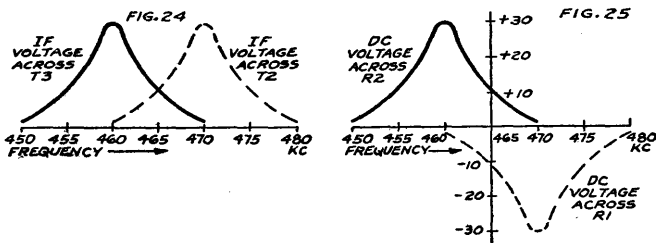

Fig. 24. The frequency response curves of T2 and T3, Fig. 23, show that maximum voltage is induced at 470 kc and 460 kc respectively. These i-f voltages are induced in the secondaries because of the coupling between the several windings

Fig. 25. Because the diodes are differentially connected, the voltage across R1 is always negative and that across R2 is always positive. Note that these curves follow those of Fig. 24, except for the change in polarity occurring during rectification

R2 for that particular frequency. This has been done in Fig. 26, and the result is an S-shaped curve which is characteristic of all types of discriminator circuits.

Effect of Staggered Tuned Circuits.

It might be well to comment upon just how this S-shaped characteristic is produced. Let us assume a variable frequency input to T1 over a range of from 450 to 480 kc. Between 450 kc and 460 kc, (in Fig. 25) the presence of the circuit T2, which is tuned to 470 kc, has practically no effect on the net voltage as shown in Fig. 26, because as Fig. 25 shows, practically no rectified voltage is produced across R1. This part of the S-shaped curve is therefore essentially the left hand side of the solid-line resonance curve in Fig. 25.

However, as the input frequency to T1 is increased above 460 kc, voltage begins to appear across R1 and at the same time the voltage produced across R2 begins to decrease, be-

cause the applied frequency is moving further away from the resonant frequency of T3. As a result of this decrease in positive voltage across R2 and the increase in the negative voltage across R1, a point is reached midway between the two resonant frequencies of T2 and T3, that is at 465 kc, where the voltage across R1 becomes equal to the voltage across R2. This will be clear to you from an examination of Fig. 25. At this frequency the net voltage produced across the combined load resistance is zero, as shown in Fig. 26. In

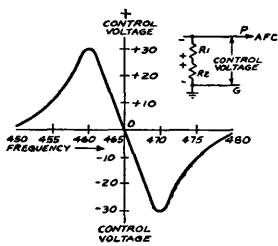

Fig. 26. This S-shaped curve represents the combined voltage across R1 and R2 and is obtained by combining for each frequency the separate voltages across R1 and R2, Fig. 25. Note that at 465 kc the control voltage is zero, due to the canceling of the voltages across R1 and R2 shown in the inset, Fig. 26B

other words, at a frequency midway between the two staggered frequencies of the secondary windings, which frequency is also equal to the correct i-f peak of the receiver, the net control voltage or AFC voltage is zero.

In a similar manner, if we combine the voltages across R1 and R2 for frequencies between 465 kc and 480 kc, as shown in Fig. 25, then we arrive at the lower half of the S-shaped curve shown in Fig. 26. You will note that the variation of the net control voltage is essentially the same both sides of the correct i-f peak. This is to be expected because the individual resonance curves (Figs. 24 and 25) are quite symmetrical.

A question now arises: is the control voltage across R1 and R2, that is between point P and ground (Fig. 26-B), suitable for the purpose we have in mind? The answer to this question depends, of course, upon the nature of the agent which is going to control the oscillator frequency and so we must defer the complete answer to this question to the next chapter. However, we can see in general that the voltage produced by this differential rectifier circuit shows

excellent possibilities for use as an oscillator control voltage. For one thing it produces zero control voltage when the signal coming through the i-f amplifier is exactly at the i-f peak. In other words, when the receiver is in perfect tune, no control voltage is generated (between P and G in Fig. 26-B) and therefore the oscillator is not disturbed. . . . So far so good. . . . Another point in favor of this circuit is that because of the differential action, the voltage remains zero as long as the receiver is in tune regardless of the strength of the incoming signal. This, of course, is very desirable, as otherwise the oscillator frequency would be dependent upon the strength of the received signal.

In addition to producing zero control voltage when the receiver is in perfect tune, the circuit also distinguishes between a signal which comes through the i-f amplifier at a frequency below the i-f peak and one which comes through the i-f amplifier above the i-f peak. It does this, as you can see from Fig. 26, by producing a positive control voltage in the one case and a negative control voltage in the other. Furthermore, the magnitude of the control voltage depends upon the extent to which the signal frequency departs from the correct value. As Fig. 26 shows, the greater the degree of mistuning, that is, the greater the deviation of the signal input from the correct value of the i-f peak,—the greater is the amount of control voltage produced.

We have explained the manner in which this circuit operates not so much because you will have occasion to work on similar circuits, but rather because the circuit is by far the easiest of discriminator circuits to comprehend. It has not found wide application in commercial receivers because, as we shall see later on, other circuits are available which produce essentially the same results and which have certain other advantages. Nevertheless, it is important that you understand how the above circuit operates; the more complicated discriminator circuits, which we are to discuss in this chapter, embody the same fundamental principles but are more difficult to understand because of certain phase relations which are involved in their operation.

The "Center-Tapped Secondary" Discriminator.

We have just discussed the discriminator circuit which makes use of two staggered tuned circuits and differentially connected rectifiers in order to obtain a control voltage suitable for AFC purposes. We mentioned the fact that this circuit has received only a very limited application and has been displaced by other types of discriminators. Let us now consider the basic discriminator circuit used in practically all receivers employing AFC.

This basic discriminator circuit is shown in Fig. 27. The most striking thing about this circuit is that it does away

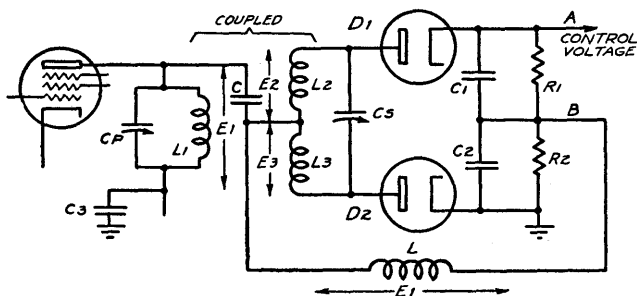

Fig. 27. The basic discriminator circuit. Note that the transformer has a center-tapped secondary L_2 and L_3 instead of the two tuned circuits heretofore discussed

with the use of two tuned circuits in the secondary of the discriminator transformer and instead makes use of a transformer with a center-tapped secondary.

To begin with, certain pertinent facts must be mentioned. If you examine Fig. 27 and for the moment neglect all of the components to the left of the two diodes, including the choke L and consider these two diodes as sources of d-c voltage—you will note that the resistance network remaining is very similar to that shown in Fig. 23, and also similar to Fig. 10.

As to the elements to the left of the two diodes, another item of interest is the transformer. As you can see, it consists of a tuned primary L_1 and a tuned center-tapped

secondary L2-L3. Coupling between the primary and secondary is accomplished in two ways. One is inductively by locating the primary and secondary fairly close together, and the second is capacitively through the condenser C which offers a low reactance (or opposition) path to the i-f signal.

Because of the nature of the coupling between the primary and secondary windings, the final signal voltage applied to the rectifier network can be considered as consisting of two parts. One part is the capacity coupled voltage and the other part is the inductively coupled voltage. With this much in back of us, we are ready to examine more critically the relation between the various signal voltages present in the system. The most convenient starting point is the signal voltage which appears across the tuned primary L1 and is designated as E1 in Fig. 27. Since the windings L1, L2 and L3 comprise an ordinary transformer, we can compare E1 with the primary voltage referred to in the various transformer illustrations shown in the review chapter.

As a result of the inductive coupling between the primary L1 and the secondary L2 and L3, a voltage appears across each half of the secondary winding, in accordance with normal transformer operation. However, in analyzing the action which takes place in this *tuned* transformer circuit you must distinguish carefully between the voltage which is induced in the secondary winding of the transformer and that which is actually developed across the secondary winding. As we explained in connection with the basic action which takes place in a transformer, the current in the primary winding sets up a magnetic flux which links the secondary circuit, and which, because it is an alternating or changing flux, induces a voltage in the secondary winding. This voltage, however, is *not* the actual voltage which is developed across the secondary winding, but is in fact considerably different from the voltage developed across the terminals of the secondary winding.

What takes place in the circuit is this: The voltage induced in the secondary winding causes a current to flow in the secondary tuned circuit. As a result of this current, a voltage is developed across each half of the secondary winding. It

is this voltage drop which we have designated as E2 and E3 and which is responsible for the discriminator action. In this connection, you should note that whereas the voltage *induced* in the secondary winding is always 180° out of phase with the voltage across the primary winding, and maintains this fixed phase relation irrespective of the frequency of the applied signal, the voltages E2 and E3 vary in phase depending upon whether the signal frequency is above or below the resonant frequency of the secondary tuned circuit. As we shall see later, it is this phase change which makes it possible for the discriminator to function.

The other part of the signal voltage transferred from the primary to the rectifier network is that fed to the network through the coupling capacity C. Of greatest importance in this connection is the fact that the voltage E1 across the primary L1 is capacitively coupled to the choke L so that the primary voltage E1 appears across the choke L. This voltage bears the same designation as the primary voltage. If you examine Fig. 27 and check the position of the choke L, you will find that it has a dual function. Basically, it is a part of the rectifier network because it constitutes the return path between the input and output circuits of each rectifier. At the same time, as far as the signal voltage is concerned, it is connected across the primary L1. The condensers C, C2, and C3 provide the proper path for the signal currents so that L is effectively shunted across L1 and the voltage across L1 is transferred to the choke L.

We now have three voltages present in the rectifier network—although it is true that of these three voltages, E2 and E3 comprise one part, and E1 the other part. What is the relation between these voltages?

Breakdown of the Differential Rectifier Circuit.

To clarify the manner in which E1 is related to E2 and E3, we shall break down the circuit into its two independent parts, each of which incorporates a diode element. The path which the current takes through the upper diode D1 is shown in Fig. 28, while the path of the current through the lower diode D2 is shown in Fig. 29. Note that what we

have done in Figs. 28 and 29 is to show that the voltage E_1 across L is in series with the voltage across the upper half of the center-tapped secondary and similarly that E_1 is in series with E_3 , the voltage across the lower half of the center-tapped secondary. In the case of the upper diode, the *i-f* voltage applied to the rectifier is equal to E_1 combined with E_2 , while in the case of the lower diode, the *i-f* voltage applied to the rectifier is equal to E_1 combined with E_3 .

In analyzing the operation of the circuit of Fig. 27 it is convenient to consider it as being equivalent to the circuit shown in Fig. 30. This is nothing more or less than a combination of the two circuits shown in Figs. 28 and 29, which

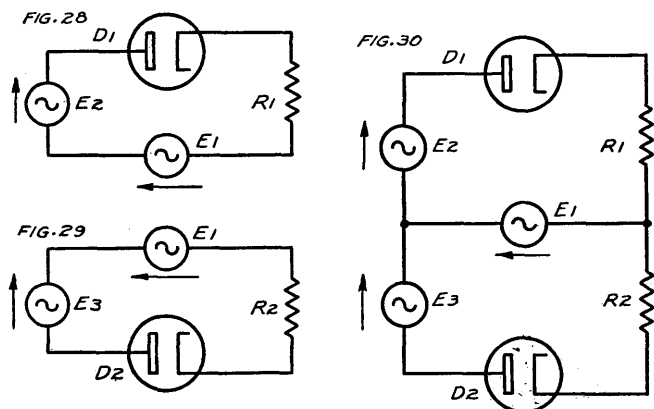

Figs. 28, 29, and 30. The discriminator circuit of Fig. 27 can be broken down into those shown in Figs. 28 and 29. The arrows indicate the path of the current through the diode circuits. Fig. 30 is a combination of the circuits at the left

inspection will show you is equivalent to Fig. 27. The balanced nature of the circuit, with particular emphasis upon the voltage E_1 across the choke L , is strikingly evident in the simplified diagram of Fig. 30.

Referring to Figs. 27 and 30, you can see that the voltage which acts upon diode D_1 and which after rectification is the d-c voltage across R_1 , is $E_2 + E_1$; further, that the voltage which acts upon diode D_2 and which after rectification

is the d-c voltage across R_2 , is $E_3 + E_1$. From this you can gather that when $E_2 = E_3$, then $E_2 + E_1 = E_3 + E_1$. Under this condition the d-c voltage produced across R_1 is equal to the d-c voltage produced across R_2 . If this voltage is, for example, equal to 10 volts, then as a result of rectification in the lower diode, point B (Fig. 27) will be negative with respect to ground by 10 volts, while point A will be positive with respect to point B by 10 volts. Since the two voltages are of opposite polarity and equal, they cancel each other so that no net control voltage is produced and the voltage difference between A and ground is therefore zero.

Importance of Phase Shift.

At first glance, it might appear that this cancellation would take place regardless of the frequency of the signal voltage. This would appear so because the value of E_2 must be equal to E_3 due to the symmetry of the circuit and because the voltage E_1 is common to both diode circuits. Why, then, should not $E_1 + E_2 = E_1 + E_3$ and zero voltage be produced across the combined diode loads for all values of signal fre-

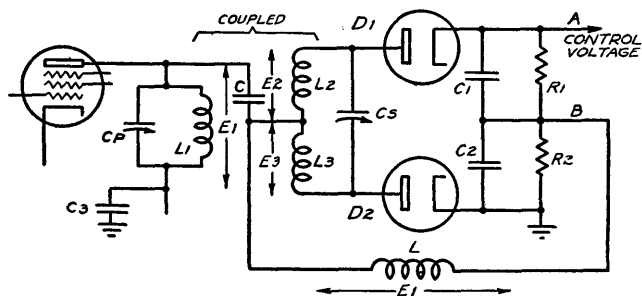

Fig. 31. This circuit is the same basic discriminator circuit shown in Fig. 27 and is reproduced here for convenience in following the text

quency? The answer to this question depends upon a consideration of the phase relations between the voltages E_1 , E_2 , and E_3 . While it is true that E_2 is equal to E_3 , E_2 and E_3 do not have the same phase. In fact, they are opposite in phase, because at the instant that one end of the secondary is positive with respect to the center tap, the other end is negative with

respect to the same point. E_2 and E_3 are, therefore, exactly 180° out of phase with each other. This you will remember is in accord with what was said about transformers in the review chapter.

When examining the phase relations in the circuit it is necessary to specify the frequency of the signal applied to the discriminator. As we shall see, three possible conditions may exist: (1) the input signal frequency may be the same as the resonant frequency to which the secondary of the transformer is tuned; (2) it may be higher than the resonant frequency; or (3) it may be lower than the resonant frequency of the transformer secondary.

In examining these phase relations, a satisfactory starting point is the primary voltage E_1 in Fig. 31. As you can see, Fig. 31 is the same as Fig. 27 and the schematic is duplicated here to simplify reading. As has already been stated, the voltage E_1 across the choke L is the same as the voltage across the primary, and this is so with respect to both phase and magnitude. The next point of interest is the current through L_1 . Since the current through an inductance lags the voltage across the inductance, we can represent I_p as being 90° degrees behind E_1 . This is done in Fig. 32 with an arbitrary

Fig. 32. The phase relations between the primary voltage and current, E_1 and I_p respectively, and the induced secondary voltage E_s . These phase relations hold true regardless of the value of the input frequency

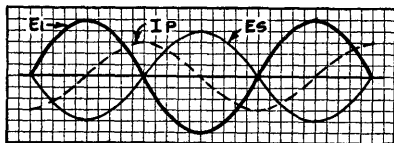

value for the magnitude of I_p . We now shift our attention to the secondary circuit.

We know that the current I_p flowing through L_1 produces a magnetic field around this winding and that this field is in phase with the primary current. Because of the coupling between the two windings, this field links the secondary and induces a voltage in the secondary of the transformer. For the sake of simplicity let us identify this induced voltage as E_s , although it is not indicated upon the schematic in Fig. 31.

34 AUTOMATIC FREQUENCY CONTROL SYSTEMS

Bear in mind that this induced voltage E_s is not to be confused with the voltages E_2 and E_3 appearing across the secondary in Fig. 31. The voltages E_2 and E_3 are *not* the voltages *induced* by the changing flux created by I_p flowing through L_1 .

The voltage E_s , which is induced in the secondary by the changing flux, has the same phase as the counter-emf developed across the primary, as stated in the review chapter. . . . Since this counter-emf is 180° out of phase with the impressed or applied voltage E_1 , it follows that the voltage E_s , which is induced by the same flux, is 180° out of phase with the primary voltage and is so shown in Fig. 32. Once more the amplitude of this secondary voltage is arbitrarily set at the value shown. This takes care of the phase relations between the primary voltage and the *induced* secondary voltage.

I.F. at Correct Value.

Up to this point we have not had to say anything about the frequency of the applied signal voltage. In order to analyze the phase of the voltages in the secondary circuit, we shall take first the simple case where the secondary circuit is tuned to resonance with the signal frequency. This statement establishes the existence of a definite condition, namely, that the capacitive reactance in the tuned secondary circuit equals the inductive reactance. Being equal and of opposite sign, they cancel and the only opposition to the flow of current in the circuit is that of its resistance.

With this in mind it follows that the voltage E_s induced in the secondary causes the flow of a secondary current I_s , which is in phase with the induced voltage. Taking arbitrary values for the induced voltage E_s and the resultant current I_s , we show them in phase in Fig. 33. Now this circulating current I_s develops a signal voltage across the secondary winding, which voltage, because of the resonant state, may be many times greater than the induced voltage. Furthermore, in accordance with the usual phase relation between current and voltage in an inductance, this voltage across the coil leads the current I_s flowing through the coil by 90° . The

voltage which is thus developed across the secondary winding is designated as E_2 and E_3 , and is divided equally between the two halves of the winding. The sum of these two voltages is the total voltage developed across the secondary as a result of the circulating current, and, as we explained in the review chapter, these two voltages are 180° out of phase. In other words, when the upper end of the center-tapped secondary is positive with respect to the center-tap, the lower end is negative by an equal amount, and vice versa.

The phase relations which have thus far been explained are summarized by the diagram shown in Fig. 33. Note that E_s has been taken as the reference voltage and that I_s is shown in phase with E_s . E_2 and E_3 are shown as respectively leading and lagging E_s by 90° and are, of course, 180° out of phase with each other.

Up to this point we have established the phase relation between E_2 , and E_3 , and the induced secondary voltage E_s What about the relation between E_2 , E_3 , and E_1 , the primary voltage which also appears across the choke L in Fig. 31 and is the other part of the total signal voltage present

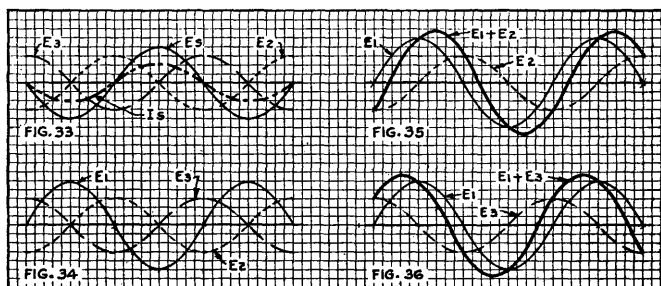

Figs. 33 to 36. The important phase relations existing in the discriminator circuit of Fig. 31 for the case where the input signal is at the resonant frequency of the secondary tuned circuit, i.e., the i - f peak

in the rectifier network? . . . We have shown that the signal voltages E_2 and E_3 lead and lag, respectively, the induced voltage E_s , by 90° . As to the primary voltage, E_1 , we know that this is 180° out of phase with the induced secondary voltage E_s . Therefore, in Fig. 34 we show E_1 as being 180° out of phase with E_s (see Fig. 33). Now, if we

locate E2 and E3, exactly as they are in Fig. 33 upon Fig. 34, we find that whereas E2 is 90° ahead of the induced secondary voltage E_s , it now is 90° behind the primary voltage E1. . . . Also that whereas E3 lags E_s by 90° in Fig. 33, it now leads E1 by 90° , as shown in Fig. 34. Note that in Fig. 34, the positive peak of E3 occurs 90° ahead of E1, whereas the positive peak of E2 occurs 90° later than that of E1.

If we now separate Fig. 34 into its two component parts showing E2 lagging E1 and showing E3 leading E1 by 90° respectively, as illustrated in Figs. 35 and 36, and establish the sum of these two pairs of voltages, we find that the sum of $E2 + E1$ equals the sum of $E3 + E1$. The net result is that the signal voltages applied to the two diodes are equal and the rectified voltages appearing across R1 and R2 (Fig. 31) are the same, therefore the net control voltage developed between ground and point A is zero. In other words, at exact resonance, when the i-f signal is of the same frequency as that to which the discriminator is tuned, the net control voltage developed is zero.

I.F. High

What happens when the i-f signal is of a higher frequency than that to which the secondary circuit is tuned? A number of conditions remain as before and a number change. . . . What remains and what changes? . . . The phase relation between the primary voltage E1 and the primary current I_p remains as before. . . . In addition the voltage E1 across the choke L is still the same as the primary voltage E1. . . . Furthermore, the induced secondary voltage E_s remains 180° out of phase with the primary voltage E1, so that the phase relations shown in Fig. 32 also apply when the signal frequency is higher than the resonant frequency of the secondary circuit.

In the secondary circuit, we find that an important change takes place. Since the circuit is off resonance, the current is no longer limited solely by the resistance of the circuit. Inasmuch as the signal frequency is higher than the resonant frequency of the circuit, the circuit behaves as if it were inductive, because under such conditions, the inductive reactance predominates. . . . A portion of the total inductive

reactance offsets the capacitive reactance and the remainder, in conjunction with the resistance, tends to limit the secondary current I_s which flows in response to the induced voltage E_s

As the consequence of this condition, the secondary current I_s lags behind the induced voltage E_s (If you remember, the secondary current I_s and the induced secondary voltage E_s were in phase when exact resonance obtained. This was shown in Fig. 33.) As a result of this phase lag, which we shall arbitrarily set at 45° , the phase relation between E_s and I_s as shown in Fig. 33, now becomes like that shown in Fig. 37, wherein I_s lags E_s by 45° . Now, the voltage developed across the secondary winding and in response to the secondary current I_s , is the voltage E_2 and the voltage E_3 . Just as in the case of perfect resonance, the voltage E_2 leads I_s by 90° . Since the voltage E_3 is 180° out of phase with E_2 , it follows that E_3 lags the current I_s by 90° . All of this is shown in Fig. 37.

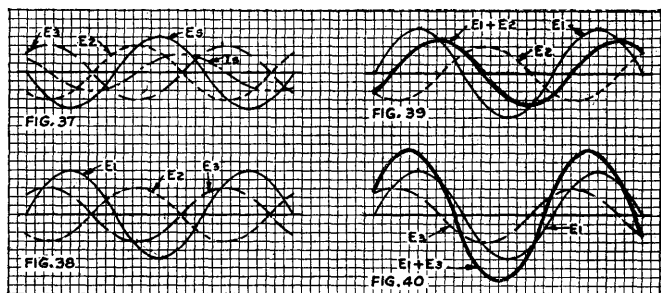

Figs. 37 to 40. The phase relations of the discriminator circuit of Fig. 31 for the case where the input signal is higher than the resonant frequency of the secondary tuned circuit, i.e., higher than the i - f peak

We now are ready to establish the phase relation between the three signal voltages in the rectifier network, namely, E_1 , E_2 , and E_3 . We know that E_1 is 180° out of phase with E_s . We further know that E_2 and E_3 are 180° out of phase with each other. . . . What must be done is to establish the phase relation between E_2 and E_1 , and E_3 and E_1 In the case of perfect resonance, if you recall, the secondary current I_s

was in phase with the induced voltage and consequently 180° out of phase with the voltage E_1 . At the same time, the lead between E_2 and I_s was 90° and the lag between E_3 and I_s was 90° . Since I_s was 180° out of phase with E_1 , the result was that E_2 was behind E_1 by 90° and E_3 was ahead of E_1 by 90° However, for the off-resonance condition being considered in this paragraph, I_s is not in phase with E_s . Instead, it lags E_s by 45° . Consequently, E_2 lags E_1 by 135° and E_3 leads E_1 by 45° . This is shown in Fig. 38. . . .

If we now break down Fig. 38 into its two component values of E_1 and E_2 , and E_1 and E_3 , bearing in mind the phase relations stated, we develop the two graphic representations shown in Figs. 39 and 40 and it is possible to establish the sum of $E_1 + E_2$, and $E_1 + E_3$ As you no doubt have noted E_2 and E_3 are of like magnitude, but the reason that the sum of E_2 and E_1 does not equal the sum of E_3 and E_1 is that the phase relation between E_2 and E_1 is not the same as the phase relation between E_3 and E_1 .

As is evident, the sum of E_3 and E_1 is greater than E_2 and E_1 , so that a greater signal voltage is applied to the lower diode and a greater rectified voltage will appear across resistor R_2 than across R_1 , with the result that the net control voltage available between point A and ground will be negative.

It is interesting to assign relative values to the various voltages which have been represented graphically in the preceding figures. If each square is taken to represent 10 volts, then it turns out that in the case of exact resonance the peak signal voltage $E_1 + E_2$ is equal to 58 volts and that $E_1 + E_3$ is also equal to 58 volts. As we previously saw in this case the net AFC control voltage produced is zero since the two rectified diode voltages cancel each other.

In the example which we just finished discussing where the frequency of the signal voltage was sufficiently high above resonance to shift the phase of the secondary current I_s by an amount equal to 45 degrees, reference to the curves in Figs. 39 and 40 will show you that the peak signal voltages are no longer equal. On the contrary, if we apply the same scale of voltage, you can readily see that $E_1 + E_2$ has decreased to 36 volts whereas $E_1 + E_3$ has risen to 74 volts.

The AFC voltage produced in this case is then determined by the difference between these two voltages and is consequently equal to approximately 38 volts. Actually the available d-c control voltage will be somewhat different from this since we have been measuring peak values of signal voltage to the diodes rather than the rectified voltages; nevertheless the principle should be quite clear.

Note that we have arbitrarily taken the case where the phase of the secondary current I_s is 45° different from that of the secondary voltage E_s . Actually this phase may be anything from zero degrees to almost 90° , depending entirely upon the frequency of the applied signal voltage. When the signal is at the resonant frequency of the secondary, the phase difference is of course zero (see Fig. 33) and as the frequency of the signal increases above resonance, I_s continues to lag in phase behind E_s . From a study of the phase diagrams it should be apparent to you how this phase shift between I_s and E_s makes possible the action of the discriminator.

I.F. Low.

Let us now consider the case where the frequency of the signal is lower than the resonant frequency of the secondary tuned circuit of the discriminator transformer. This corresponds, as you know, to the condition where the oscillator frequency in the superheterodyne is too low and must be raised so as to insure proper tuning. In considering this case we need not investigate the primary voltage E_1 , the choke voltage E_1 , or the secondary voltage E_s since we have previously seen that these voltages remain the same regardless of the frequency of the input signal.

As before, the first change takes place in the secondary circuit with reference to the current I_s . Since the frequency of the signal is below the resonant frequency of the secondary, the capacitive reactance exceeds the inductive reactance and I_s is thus limited by the capacitive reactance in combination with the resistance in the secondary tuned circuit. As in any capacitive circuit, the current leads the voltage, and so we have shown the current I_s leading the voltage E_s by 45° in Fig. 41.

This current I_s develops the voltages E_2 and E_3 across the two halves of the secondary winding, and as in each of the two previous cases, E_2 leads I_s by 90° and E_3 lags I_s by 90° . These two voltages are also represented in their proper phase relation to I_s in Fig. 41. In Fig. 42 the three voltages E_1 , E_2 , and E_3 present in the rectifier network are shown by themselves. You will recall that this diagram is obtained from that of Fig. 41 by keeping in mind that E_1 is 180° out of phase with E_s .

To find the magnitude of the AFC voltage which will be produced for this case, we must again investigate the sum of $E_1 + E_2$ and $E_1 + E_3$. In Figs. 43 and 44, we arrive at the result that $E_1 + E_3$ is appreciably less than $E_1 + E_2$.

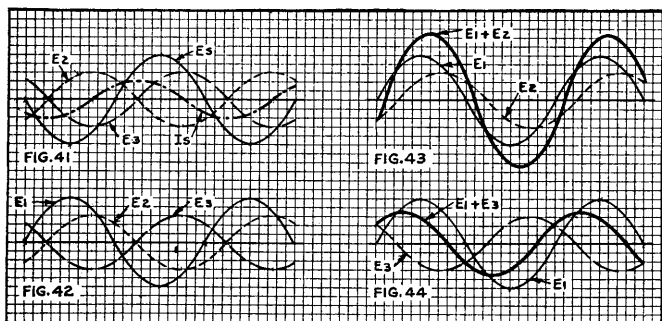

Figs. 41 to 44. The phase relations existing in the discriminator circuit of Fig. 31 for the case where the input signal is lower than the resonant frequency of the secondary tuned circuit, i.e., lower than the i-f peak

If we compare the magnitudes of these resultant voltages, then it is evident that for the units we have assigned, $E_1 + E_2$ is equal to 74 volts, while $E_1 + E_3$ is equal to only 36 volts. You should note especially that this case is in direct contrast to the case where the signal was higher than the resonant frequency. In the latter case $E_1 + E_3$ was greater than $E_1 + E_2$ while in this case with the signal frequency below the resonant frequency, the exact reverse holds true. If we interpret this in terms of the control voltage produced across the diode load, then it is apparent that for the signal frequency below the resonant frequency, the rec-

tified voltage across R1 will be greater than that across R2, so that a net positive control voltage is produced. Subtracting the two signal voltages from each other, we obtain a value of 38 volts as a measure of the positive control voltage produced under this condition. You will observe that for the same degree of detuning on the other side of resonance, a negative value of 38 volts is produced.

If we were to trace out the values of control voltages produced for different degrees of detuning, then we should arrive at the familiar S-shaped discriminator characteristic shown in Fig. 26. However, we have considered the three representative cases, where the signal is at the resonant frequency, above the resonant frequency, and below the resonant frequency and for intermediate values of signal frequency the action is basically the same, except that the secondary current will lag or lead by a varying number of degrees depending upon the frequency of the signal. For any value of signal frequency, the S-shaped curve in Fig. 26 can be used to predict the value of control voltage which will be produced.

Importance of Secondary Tuning.

From our discussion of this type of discriminator you are in a position to understand the importance of the correct adjustment of the secondary tuning of the discriminator transformer and the part that this plays in determining the operation of the entire system. In the final analysis it is the tuning of this secondary which determines the polarity and magnitude of the control voltage developed by the entire discriminator system. On the other hand, the tuning of the primary of this transformer is of relative unimportance, since if you check back over the operation of the system, you will see that the phase of the voltages involved is unaffected by the tuning of the primary winding.

Of course, we do not mean that the primary winding does not have to be tuned properly to the signal. While it is true that the primary winding does not affect the phase of the currents and voltages induced in the balanced rectifier network of the discriminator, it does affect the magnitude of the voltage fed to the discriminator and in this way improper

tuning of the primary winding will reduce the voltage which reaches the discriminator tube. However, the primary tuning is hardly more critical than the usual i-f trimmer adjustment and, by comparison with the secondary trimmer, is comparatively simple to adjust. It should be emphasized that it is the secondary trimmer which controls the frequency of zero voltage output on the S-shaped discriminator curve, while it is the primary trimmer which determines the amplitude of the two peaks of the S-shaped curve as well as the symmetry of the AFC control. These points are discussed in more detail in the chapter on the alignment of AFC circuits.

Discriminator without I-F Choke.

The discriminator circuit shown in Fig. 45 makes use of the same basic circuit which has just been described but with

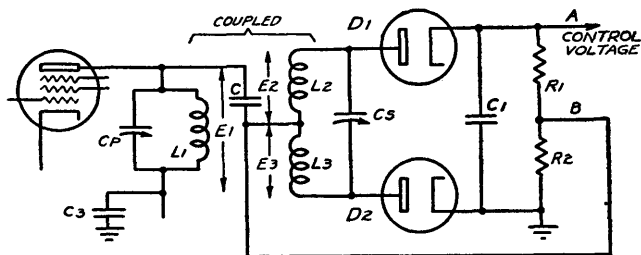

Fig. 45. This form of discriminator circuit is similar in operation to that shown in Fig. 31. The omission of the by-pass condenser at the junction of R1 and R2 makes it possible to eliminate an i-f choke for coupling the voltage E1 into the diode circuit

several minor changes. Of primary interest is the fact that the i-f choke L, shown in Fig. 27, is omitted in Fig. 45 and but one condenser is connected across the load resistor, and in a different manner.

In the light of the discussion concerning the previous type of discriminator system, we can readily analyze the manner in which the circuit of Fig. 45 operates. The essential point of departure is that the voltage E1, which appears across the primary circuit of the transformer, is transferred across the two load resistors R1 and R2, as a result of the absence of

the previously used by-pass condenser at the junction of R1 and R2. Just how this is done will be described in the following paragraph.

If you examine the circuit of Fig. 45, you will find that as far as the i-f current and voltage are concerned, one end of the primary winding which is the source of the primary voltage E_1 , is connected to ground through a condenser C3. Further examination discloses that as a result of the lead which joins condenser C to the top of the load resistor R2, this resistor is connected in shunt with the primary winding and consequently the full primary voltage appears across this resistor. If you continue the examination of Fig. 45, you will find that R1 likewise is in shunt with the primary winding. The return path to ground is through the condenser C1. A breakdown circuit illustrating these connections is shown in Fig. 46, with the parts identified to conform with Fig. 45.

Fig. 46, right. This breakdown of Fig. 45 shows that the resistors, R1 and R2, are effectively in parallel across the primary winding. The reactance of C and C1 is small in comparison with R1 and R2

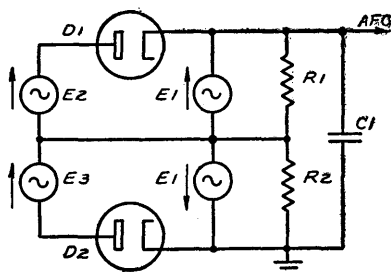
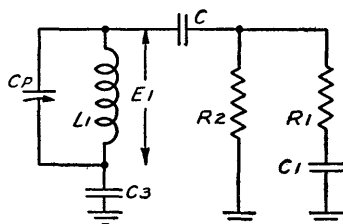

Fig. 47, left. The breakdown diagram, Fig. 45, shows that the voltage acting to produce current in R1 equals $E_1 + E_2$, while the resultant voltage in the lower diode circuit equals $E_1 + E_3$

The voltages E_2 and E_3 , shown in Fig. 45, are determined in exactly the same way as described in connection with Figs. 27 and 31. The manner in which the voltages E_2 and E_3 combine with the primary voltage E_1 , as it appears across each of the resistors R1 and R2, is shown in Fig. 47. The

circuit illustrates the series connection of the E2-E1 and E3-E1 voltages respectively in each diode circuit.

As in the case of the previously described discriminator system, the voltage which acts on the upper diode D1 is $E2 + E1$ and the voltage which acts on the lower diode D2 is $E3 + E1$. As you can see by comparing Fig. 47 with Fig. 30, both circuits are identical from the viewpoint of symmetry and since the phase relations present in the circuit are the same as stated in connection with Fig. 32 and the subsequent related figures, it is natural that the rectified voltage, which appears across the output of the rectifier, will follow the same S-shaped curve of Fig. 26. It is not necessary to go into any further details concerning the operation of this system, because in all other respects it is identical to that previously described.

The Westinghouse Discriminator.

What is a somewhat different type of discriminator network is used in a number of different receivers, among them the Westinghouse receivers. However, before entering upon the description of this type of discriminator, we feel that it might be well to describe briefly an elementary rectifier system which is used in the complete discriminator, and then to discuss the complete system. In Fig. 48 is shown a simple

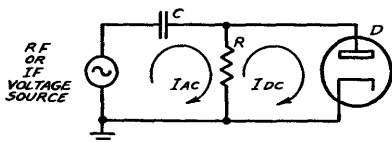

Fig. 48. A widely used type of rectifier circuit. R is a load for the high-frequency voltage and is a path for the rectified current

rectifier network. A generator supplies a voltage which is fed through a condenser C to a rectifier network consisting of a diode D and a resistor R. The point of major interest is the resistor and the diode. As you can see, the r-f or i-f voltage developed across the resistor is the signal voltage applied to the diode. Alternately the plate of the diode becomes positive and negative with respect to its cathode and a rectified current flows around the diode-resistor circuit.

If you examine this circuit closely you will find that it

differs from the conventional rectifier circuit in that the diode load is in shunt with the plate-cathode circuit, whereas in the usual diode type of rectifier, the load is in series with the source of voltage and the diode. Furthermore, the by-pass condenser across the load resistor is omitted. Such omission is essential in order that signal voltage be developed across the resistor. If a by-pass condenser were used, it would by-pass the signal voltage around the resistor and the circuit would not function.

A discriminator system wherein two rectifiers of this type are used is shown in Fig. 49. At first glance you will note

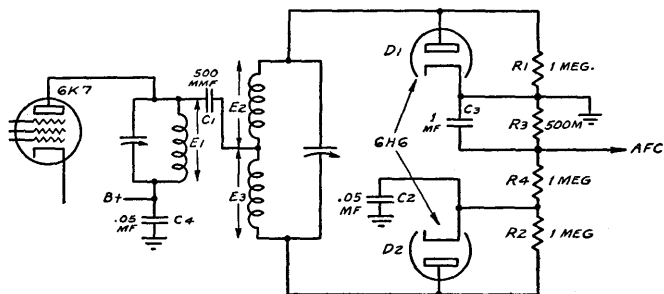

Fig. 49. The discriminator circuit that is employed in the Westinghouse WR-315 receiver

a certain similarity between this discriminator and those previously shown—at least as far as the primary and secondary voltages and the circuits of the transformer are concerned. However, the actual rectifier system, including the diodes and their related resistors, differs markedly from what has been shown thus far. . . . If you check the circuit closely, you will find that a fixed resistor is connected across the plate-cathode circuit of each diode—R1 across D1 and R2 across D2.

Very little, if anything need be said about E1, E2 and E3, because these voltages are identical in character to those mentioned in the previous two descriptions of discriminator circuits. E1 is the primary voltage and E2 and E3 are the two voltages developed across the two halves of the secondary winding as the result of the circulating current. The phase relations between the primary and secondary circuit voltages

and currents are identical to those already discussed. . . . The only major item left is to examine the operation of the circuit and to see how these voltages are related to the diode circuits.

One significant fact is evident in the diagram of Fig. 49. The usual connection between the center tap of the transformer secondary and the diode circuit is absent, which brings to light a definite lack of symmetry. To examine this circuit more critically, let us rearrange the network into its two major divisions, that is, isolate the voltages with respect to the diodes. . . . This is done in Fig. 50, which is identical to Fig. 49, except that the resonant circuits responsible for the various signal voltages have been replaced with generators identified with the respective voltages. For example, to the left of the vertical dividing line, we show the primary voltage E_1 and the isolating condenser C_1 . The voltage E_1 corresponds to the same voltage shown related to the tuned primary in Fig. 49. . . . To the right of the vertical dividing line we show the voltage E_2 in series with diode D_1 , which in turn is shunted by R_1 , terminating at ground. If you check against Fig. 49, you will find that both symbols and connections are identical.

Voltage E_3 in Fig. 50 is in turn connected in series with its diode D_2 , which is shunted by resistor R_2 , and the whole arrangement connected to ground through resistors R_3 and R_4 . This, too, corresponds with Fig. 49. The fact that all of the resistors are shown joined in Fig. 49, whereas they are apparently separated in Fig. 50, is of no consequence. R_3 and R_1 in Fig. 49 terminate at ground, which is also the connection in Fig. 50 and hence the two diagrams are identical in this respect. The placement of the by-pass condensers in Fig. 49 is repeated in Fig. 50, so that it is possible to study the operation of the circuit shown in Fig. 49 by analyzing the circuit of Fig. 50.

If we now consider the circuit in Fig. 50, it is evident that the voltage E_1 is in series with E_2 and also with E_3 . The blocking condenser C_1 has no bearing upon the magnitude of the various signal voltages. It serves solely to isolate the d-c voltages associated with the primary winding of the transformer from the secondary circuit and to place the primary voltage in series with the secondary voltages.

From the viewpoint of the paths offered to the flow of alternating current we find that one is through E1-C1-E2-R1 to ground, while the other is through E1-C1-E3-R2-C2. In each of these descriptions, the signal voltage effective upon each of the diodes is that developed across the resistor which shunts its respective diode. . . . in other words, the signal voltage developed across R1 for D1, and that developed across R2 for D2. Referring once more to the a-c path, you may wonder why we have omitted reference to R4 and R3. . . . If you examine the location of C2 with respect to R3 and R4, you will find, particularly in view of the electrical values of these components, that the path through C2 to ground offers very much less opposition than the path through R3 and R4 to ground. As shown in Fig. 49, the values of R3 and R4 are of the order of a megohm each, whereas the reactance of C2 and C3 at the signal frequency is an extremely small fraction of R3 and R4. Hence the diode circuit terminates at ground through C2, and R3 and R4 are of no importance in connection with the path of the *signal* currents.

Fig. 50. A breakdown circuit of the Westinghouse discriminator circuit, Fig. 49. Note that the circuit uses two diode rectifiers similar to the circuit of Fig.

48

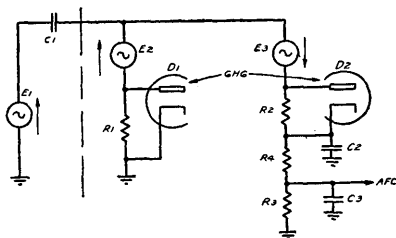

As to the signal voltages active in the circuit, the voltage which is effective in causing rectified current to flow through R1 is $E1 + E2$ and the voltage which is effective in causing rectified current to flow through R2 is $E1 + E3$.

As to the rectified current path, there is no pulsating-current flow through C1 and E1, because of the presence of C1. However, a flow of rectified current does take place through the diode D2, with the result that a d-c voltage is developed across R1. . . . A similar situation exists in the case of R2 and the diode D2, with the result that a d-c voltage is developed across R2. . . . Now, with a d-c voltage present across R1 and another d-c voltage present across R2, current flow does take

signal is lower than the resonant frequency of the secondary, then from the previous discussion we know that $E_1 + E_2$ is greater than $E_1 + E_3$. The conditions in this case are represented in Fig. 52 wherein the voltage across R1 has been taken as 35 volts, while the voltage across R2 has been assumed to be 25 volts. If we consider the two diode-resistance combinations for the moment as batteries with no internal resistance, then it becomes clear that a current will flow around the circuit, because a net voltage tends to drive current through R3 and R4. As a result of this current flow, inspection of Fig. 52 will at once show you that the point P will assume a potential 10 volts below ground and therefore a net negative control voltage of 10 volts will be available.

Similarly, if we take the case in which the signal frequency is higher than the resonant frequency of the secondary, then we know that $E_1 + E_2$ will be smaller than $E_1 + E_3$. If we assume that in this case the d-c voltage across R1 is 25 volts and that across R2 is 35 volts, then we have the conditions represented in Fig. 53. Again, these voltages oppose each other and, as a result of the flow of current, a 10-volt drop is produced across R3 and R4 in series, so that a positive control voltage of 10 volts is made available for control purposes.

In the actual circuit arrangement, only that fraction of the control voltage present across R3 is used for AFC; R4 in conjunction with C3 acts to filter as well as reduce the voltage which is finally applied to the oscillator control tube.

In presenting this simple explanation of how the circuit operates, we have made the assumption that the two diodes and their respective loads can be replaced by batteries with zero internal resistance. Actually, this is only a first approximation, since the rectified current flowing through R1 and R2 does develop a voltage drop which we have neglected in the above elementary explanation. Nevertheless, the illustration is valuable in that it explains simply, although qualitatively, the manner in which the circuit operates.

The Triple-Tuned Discriminator.

Another type of discriminator which deserves attention at this time is used in a number of Sears-Roebuck receivers. Pos-

sibly it will be found in other receivers as well, but at any rate, it is somewhat different from the discriminators previously described, at least as far as the transformer is concerned, and hence its inclusion at this time. Incidentally, a number of other discriminator arrangements are described elsewhere in a subsequent chapter.

The triple-tuned discriminator circuit under discussion is shown in Fig. 54. If you examine this diagram, you will note that the discriminator transformer contains three tuned circuits. These are $L1-C1$, $L2-L2'-C2$, and $L3-L4-C3$. $L1$ is coupled to one of the $L2$ windings. The other $L2$ winding, $L2'$, is in turn coupled to $L3$ and $L4$. In each of these cases the coupling is inductive. However, there is a direct link between one end of $L2$ and the junction of $L3$ and $L4$.

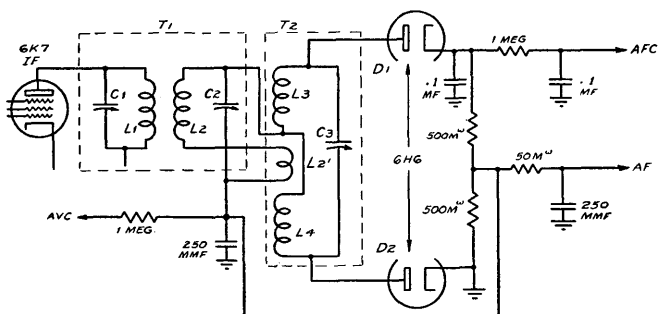

Fig. 54. The triple-tuned discriminator circuit that is used in several Sears-Roebuck receivers. This is a modification of the basic discriminator circuit and it should be noted that the three windings are enclosed in two separate shields, as indicated by the dotted lines

As to the operation of this transformer with respect to the signal voltages present in the circuit and the phase relation of these voltages, we need concern ourselves only with windings $L2$ and $L3-L4$. The primary winding $L1$ does not enter into the discussion, other than as a source of the voltage fed into the other two windings.

As to the coupling between the secondary and tertiary windings, we have the equivalent of the capacitive and inductive coupling found in all of the preceding cases. The direct coupling, equivalent to the capacitive coupling, is achieved

by means of the direct link between the upper end of L2 and the junction of L3 and L4. The inductive coupling is that which exists between the second section of L2 or L2' and L3-L4. As you can see in the diagram, the secondary tuning condenser C2 is connected across the series combination L2-L2'.

In operation this circuit utilizes the phase relations between the voltage across the secondary tuned circuit L2-L2'-C2 and that across each half of the tertiary winding, or across L3-L4. In this instance, the signal voltage across L2-L2' is the equivalent of the previously mentioned E1, and the voltages across L3 and L4, are the equivalents of the previously mentioned E2 and E3. Concerning the phase relations, they are identical to those described in connection with the previously discussed types of discriminator circuits, and consequently it is hardly necessary to discuss them again. It might be well, however, to mention that with the exception of the transformer circuit, the remainder of the system is basically similar to the first type of discriminator we described. If you trace the connections between the secondary and tertiary circuits, you will find that the center tap of the load resistors in the output circuit of the diodes, returns to the midtap of the tertiary winding through the two sections of the secondary winding. Of further interest is the fact that this three-winding transformer is contained within two separate shielded compartments.

The manner in which the various signal voltages combine to form the voltages acting upon the two diodes can be best

Fig. 55. A breakdown of the circuit of Fig. 54 showing the several voltages acting in the two diode circuits. Note that the audio voltage is also secured from this system

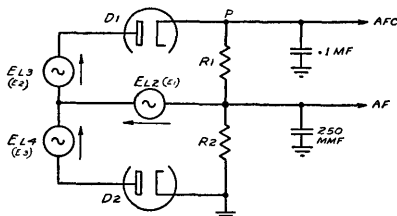

noted by reference to the breakdown diagram shown in Fig. 55. This is a simplified version of Fig. 54, and the various voltages involved in Fig. 54 are identified. Once again you see that the voltage across the secondary tuned circuit L2-L2'-C2,

which voltage we identify as E_1 , is directly in series with the voltage across L_3 (identified as E_2) and the diode D_1 . The lower diode D_2 is in series with E_1 , across $L_2-L_2'-C_2$, and the voltage E_3 , which appears across L_4 . The total voltage applied across D_1 is $E_1 + E_2$ and that applied across D_2 is $E_1 + E_3$. As a result of the phase relations, the characteristic S-shaped discriminator curve is developed. The final AFC voltage appearing between point P and ground is equal to the combined value of the voltages across R_1 and R_2 , as was previously explained.

Further examination of Fig. 54 establishes that the automatic volume control voltage is also secured from the discriminator system. This is made possible by connecting the AVC feeder to the junction of R_1 and R_2 ; this point in the discriminator circuit is negative with respect to ground at all times and satisfies all the requirements for an AVC voltage source. As has been stated, the final AFC voltage utilized for AFC purposes varies in polarity and magnitude in accordance with the voltages present across R_1 and R_2 , but no matter what the final AFC voltage, the voltages across R_1 and R_2 when considered individually are always the same in polarity. As a result of the connection of R_2 , the polarity of the rectified voltage across R_2 is such that the ungrounded point is always negative with respect to ground.

The use of the discriminator to obtain both AFC and AVC voltages is not peculiar to this type of discriminator alone since it is possible to obtain AVC voltages from each of the discriminator circuits previously described. In general, the AVC voltage is obtained by connecting the AVC feed line to the junction of R_1 and R_2 ; however, if the full voltage is not required, it is possible to take off the desired amount by tapping R_2 . On first thought it might seem that the AFC action is closely related to the AVC action, but actually such is not the case. To the extent that the AVC circuit limits the signal voltage applied to the discriminator, it does affect the amount of AFC voltage, but essentially the AFC voltage depends upon the condition of tuning, whereas the AVC voltage changes only slowly with the tuning and depends essentially on the input signal to the receiver.

CHAPTER IV

THE OSCILLATOR CONTROL CIRCUIT

IN THE previous chapter we discussed the discriminator, and showed that this portion of the AFC system produces a d-c voltage which varies in magnitude and polarity in accordance with whether or not the receiver oscillator is tuned to the correct frequency. This voltage we referred to as the control voltage, or AFC voltage. We are now ready to consider the circuit which receives this control voltage and automatically controls the oscillator frequency so as to keep the receiver correctly tuned. To present this subject properly, it is necessary to consider a basic oscillator circuit, and to examine the requirements of such control circuits and the various possible methods of control.

Suppose that we start with a simple oscillator circuit, such as is to be found in the conventional superheterodyne receiver. The circuit of Fig. 56 illustrates a conventional plate feedback oscillator, wherein a portion of the alternating voltage in the plate circuit is fed back into the grid circuit and sustained oscillations are produced. As you no doubt know, one of the major considerations of any oscillator system is the frequency of the oscillations produced. The control of the frequency produced is accomplished, generally speaking, by the values of inductance L and the capacity C present in the tuned circuit. More specifically, the frequency of the oscillator can be expressed by the relation $f = \frac{1}{2\pi \sqrt{LC}}$.

Obviously, the larger the value of L or C , the lower is the frequency of the oscillations produced; and similarly, the

smaller the value of L or C , the higher is the frequency of the oscillations produced. . . . So we see that the most obvious method of frequency control is by the variation of the magnitude of either L or C in the tuned circuit.

Recognizing the physical nature of L and C , control of the frequency by variation of these components is quite a task. However, it is possible to vary L mechanically, for example, provided that L is of such construction that the final inductance is the result of the physical relation between two coils—so that by varying the position of the two coils

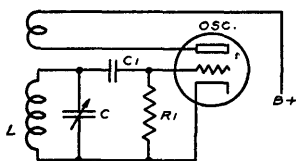

FIG. 56

Fig. 56. In this conventional oscillator circuit, the frequency is determined by L and C

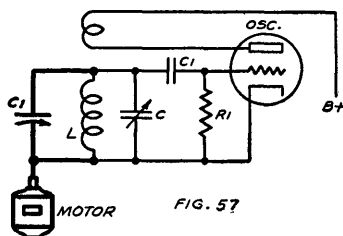

FIG. 57

Fig. 57. The frequency of oscillation can be varied by means of a motor-driven variable condenser, $C1$, shunted across the tuned circuit

mechanically a change in the resultant inductance is effected. No doubt you recall the use of variometer-type inductors, wherein a rotatable form carried one winding and a fixed form carried the other winding. If the frequency were varied by such a motor-driven variometer, zero control voltage would not cause any movement of the rotor, whereas a negative control voltage would cause movement in one direction and a positive control voltage would cause movement in the opposite direction. . . . The same applies to a motor driven auxiliary condenser.

An example of the capacitive method of control over the oscillator frequency is shown in Fig. 57. Here the control is accomplished by connecting the rotor shaft of an auxiliary condenser $C1$ to a motor. If the receiver is correctly tuned, the control voltage is zero and the auxiliary condenser rotor remains stationary at its neutral position—half capacity. If,

as the result of incorrect tuning, the oscillator frequency is too high, the discriminator produces a negative control voltage and this voltage causes the condenser motor to rotate the condenser C1 in Fig. 57, so that the capacity of C1 is increased and the oscillator frequency is lowered. In the event that the oscillator frequency is too low, a positive control voltage is produced by the discriminator and this control voltage causes the motor to rotate C1 so that the capacity is decreased, and the oscillator frequency is increased.

Such would be the method of operation if motor driven variable inductors or condensers were used. . . . However, the system is not used commercially, so that possibly you may wonder why we have given such a lengthy description. The value of the illustration lies in the fact that the circuits which are being used in present-day receivers also use the variation of the inductance or capacity in the oscillator tuned circuit in order to control the oscillator frequency. However, in contrast to the examples just given, the means used to accomplish this variation of the total inductance or capacity in the oscillator tuned circuit is purely electronic, rather than electromechanical; no moving parts whatsoever are used. Nevertheless, the above illustration of mechanical oscillator control should be understood, since it shows the relationship between the oscillator frequency, and the inductance and capacity present in the oscillator tuned circuit.

Vacuum Tube Circuit as an Inductance.

The type of electronic control circuit which is most widely used and which we shall consider first, is that which uses a tube to act as an *apparent* inductance across the oscillator tuned circuit. If we may digress for a moment, it might be well to say a few words concerning the use of two inductances in parallel. You are no doubt familiar with the fact that when two resistors are connected in parallel the resultant value of resistance is less than that of the smaller value of resistance in the parallel combination. The same relation holds true with inductances. Connecting one inductance in parallel with another results in a final value of inductance which is less than the smaller of the two used.

Referring to the electronic method of AFC, the inductance used in the oscillator tuned circuit is the fixed inductance and the additional apparent inductance, which is electronically controlled, is in shunt with this fixed inductance. By varying the apparent inductance electronically between certain fixed limits, it is possible to produce a resultant value of inductance which is greater or smaller than the value which exists when the control voltage is zero.

At first glance it is difficult to conceive of an inductance which does not exist in physical form, that is, a coil. It is correspondingly difficult to visualize how a vacuum tube circuit can behave as if it were a coil. . . . Nevertheless, such is the case, as you shall see. . . . To start the discussion we shall refer once more to the behavior of an inductance when used in an a-c circuit. In Fig. 58 is shown a coil connected across a source of alternating emf. Naturally a current I will flow in response to the voltage E and this current will lag the voltage by 90 degrees.

Now, let us suppose that the generator shown in Fig. 58 is connected to two terminals located on a box with contents

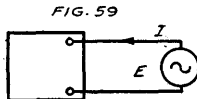
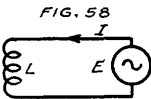

Fig. 58. The current I flowing in this a-c circuit lags 90° behind the voltage E . Fig. 59. If the current in this circuit lags 90° behind the voltage, then the box must contain apparatus which behaves like an inductance

unknown, as shown in Fig. 59. An ammeter is located in the circuit; again we find that a current I flows in response to the voltage E and further, that this current I lags behind the voltage E . Under the circumstances, it is natural to conclude that whatever is within the confines of the box displays the properties of an inductance or, in other words, is an inductance. Expressed in another manner, the only way in which we can establish if the contents of the box is resistive, capacitive, or inductive in effect, is by the phase relation between the current and the voltage.

Bear in mind that we do not know the physical shape or appearance of the device within the box. As a matter of fact, we are not concerned with whether or not this device resembles our conventional ideas of a coil, condenser, or resistor. The evidence of a 90-degree lag between the current and the voltage is sufficient to establish that whatever is in the box is inductive or behaves like an inductance. Similarly, if the current leads the voltage by 90°, then we can correctly conclude that the device within the box is a condenser or at least displays the properties of a condenser. For values of phase lag or lead between zero and 90°, the box appears as a combination of resistance and inductance, or resistance and capacity, respectively.

So much for the basic ideas as to the distinguishing feature of an inductance from the electrical point of view. . . . Now the problem is to make a vacuum tube appear as an inductance. . . . In other words, to have within that box a vacuum tube circuit which will draw a lagging current I from a source of applied voltage E .

The first stage in the development of a tube circuit which will act as an inductance is shown in Fig. 60. The circuit is

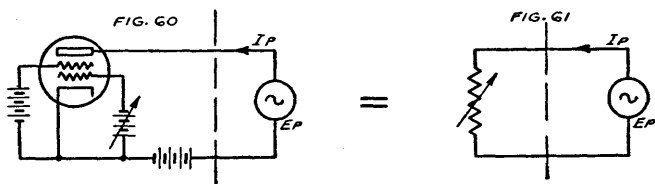

Fig. 60. By varying the grid bias, the tube circuit to the left of the dotted line can be made to appear to the a-c generator E_p as a variable resistance. Fig. 61 shows the tube circuit represented as a variable resistance

a conventional four-element tube with a source of d-c voltage connected to the control grid, a d-c voltage connected to the screen grid, and an a-c voltage E_p connected to the plate. The current I_p flows in the plate circuit as the consequence of the application of E_p . Certain pertinent facts related to this circuit are of interest. In the first place, we know that the magnitude of plate current for any value of plate voltage depends upon the internal resistance of the tube and that

58 AUTOMATIC FREQUENCY CONTROL SYSTEMS

one of the means of varying the internal resistance is by means of the control-grid bias. The more negative the grid, the greater the internal resistance of the tube and the less the plate current for any value of plate voltage. In the same way, the lower the negative grid bias, the lower is the value of internal resistance, so that by varying the control grid bias, the tube can be made to behave as if it were a variable resistance. Acting in this manner, that is, as a resistance, the plate current I_p is in phase with the applied voltage E_p and the circuit of Fig. 60 is really the equivalent of Fig. 61. Thus it is possible without using a resistor of any kind to arrange a tube so that it appears as a resistor to the generator E_p .

However, we are interested in the behavior of the tube as an inductance rather than a resistance. How can this be accomplished? An elementary conception of the circuit arrangement used is shown in Fig. 62. The method of operation

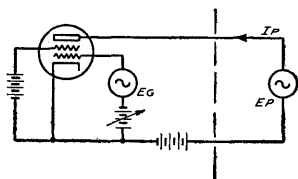
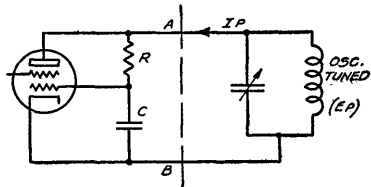

Fig. 62. If E_g lags E_p by 90° , then the tube circuit to the left of the dotted line appears to the a-c generator E_p as a variable inductance

is to feed into the control-grid circuit, an alternating voltage which is identical in frequency to that of the alternating voltage applied to the plate circuit. As a matter of fact, as you will see later, the alternating grid voltage E_g , is secured from the source of the alternating plate voltage E_p , thereby assuring identically the same frequencies for E_p and E_g . Furthermore, the manner in which E_g is fed into the control-grid circuit is such that this voltage lags 90° behind the plate voltage. The plate current, which is in phase with the grid voltage, therefore lags the alternating voltage in the plate circuit by 90° , so that as far as the alternating plate voltage E_p is concerned, the tube appears as an inductance. This follows, as explained above, because the alternating plate current I_p lags E_p by 90° . By applying a variable d-c bias to the control grid, the magnitude of the mutual conductance, and therefore the magnitude of the plate current I_p can be

controlled. This is in turn reflected as a variation of the inductance presented by the tube to the generator. The greater the plate current, the less the apparent inductance, and the smaller the plate current, the greater the apparent inductance. As you will see later, this variable control-grid bias is the control voltage which is secured from the discriminator tube. . . . So much for this elementary description. Let us continue by discussing a practical circuit wherein the control tube acts as an inductance across the oscillator circuit and the method of securing the out-of-phase voltage necessary for the operation.

Fig. 63. R and C form a phase-shifting circuit by means of which a lagging voltage is applied to the grid of the tube. The d-c voltages are here omitted for the sake of simplicity



Such a practical circuit is shown in Fig. 63 and if you compare Figs. 62 and 63, you will find a certain amount of similarity between them. The generator E_p of Fig. 62 is now replaced with the oscillator tuned circuit, labeled E_p . This circuit is a portion of the oscillator system, the frequency of which is to be controlled, and during its operation an alternating voltage is developed across the coil. The complete oscillator system is not shown because it is unnecessary for the explanation.

Referring again to Fig. 63, you will note that a series network composed of a resistor R and a condenser C shunts the tuned circuit and also is connected across the plate-grid-cathode circuit of the tube. This resistance-capacity network comprises a phase-shifting device, to provide the lagging grid voltage discussed in connection with Fig. 62. The values selected for R and C are as a rule such that R is much greater than the reactance of C , so that the two combined appear as a resistive load upon the oscillator tuned circuit. Therefore, the current due to E_p through this R - C combination is essentially in phase with the oscillator voltage E_p . However, we know that in a condenser the current leads the voltage by 90° , so

that since the current through the condenser C is in phase with the voltage E_p , it stands to reason that the voltage across C —and this is the voltage which is applied to the control grid—must lag the oscillator tuned circuit voltage E_p by approximately 90° . Thus we excite the control grid with a voltage which has the same frequency as E_p , but lags E_p by 90° .

Continuing further, this control-grid voltage naturally causes the flow of a corresponding alternating current I_p in the plate circuit and this plate current is in phase with the control-grid voltage. Since the control-grid voltage lags the oscillator voltage E_p by 90° and the plate current I_p is in phase with the control-grid voltage, it follows that the plate current will also lag the oscillator voltage E_p by 90° .

The effect of the circuit arrangement just discussed is that the control tube draws a lagging current I_p in response to the grid excitation voltage which is derived from the phase shifting circuit across the oscillator tuned circuit. In this way, the control tube is made to appear to the oscillator tuned circuit as an inductance, as we explained in connection with Figs. 58 and 59. Furthermore, since it is possible to vary the magnitude of the lagging current I_p by applying a variable control-grid bias, the control tube behaves like a variable inductance in shunt with the oscillator tuned circuit.

With this much of the discussion completed, you may be wondering about the relation between the oscillator frequency and the value of the apparent inductance reflected by the control tube. It is important to note that the control tube is always connected across the oscillator tuned circuit, so that there is always present across the oscillator coil a certain value of apparent inductance. This is the value that exists when the AFC control voltage is zero, and the design of the oscillator coil system is such that the correct frequency is obtained with this value of apparent inductance across the oscillator coil. Then when AFC control voltage is applied, the apparent inductance increases above this zero control voltage value or decreases below the zero control voltage value, depending upon the polarity of the control voltage. When the apparent inductance increases, the total inductance in the oscillator circuit rises and the frequency is lowered. . . . When the appar-

ent inductance decreases, it naturally decreases the total inductance and the frequency of the oscillator is raised. Elaborate as the complete system may appear, it is actually the equivalent of Fig. 64, wherein an automatically varying inductance is in shunt with the oscillator winding. This apparent inductance is shown in dotted lines.

Now that you are familiar with the manner in which a vacuum tube can be arranged to act as an inductance, it is

Fig. 64. The shunt inductance L makes it possible to control the frequency of the oscillator as explained in the text

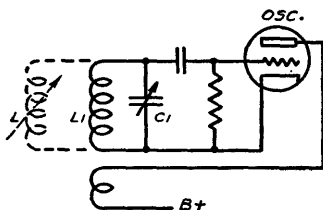

in order to show how the control tube is tied in with a conventional oscillator circuit. In general, the basic arrangement shown in Fig. 65 is generally used, although there are some slight modifications in the different receivers, which represent the individual ideas of various set designers. While the resemblance between Figs. 65 and 63 is not great at first glance,

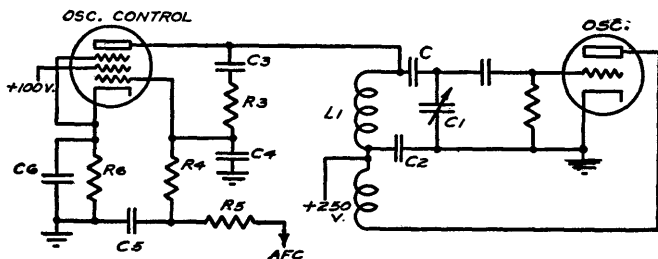

Fig. 65. A basic oscillator control tube circuit, showing how it is connected to the oscillator circuit. $R3$ and $C4$ supply the lagging grid voltage, while $C3$ keeps the d-c voltage from the grid of the control tube

closer inspection will show the two circuits to be identical with the exception that by-pass condensers and isolating or filter resistors have been added to the circuit of Fig. 65. Starting with the oscillator system, you will note that it is

of conventional design except for the use of the oscillator grid coil above ground potential. This is done so as to permit the application of d-c plate voltage to the control tube through the oscillator grid coil. It is for this reason that the series blocking condensers C and C2 are used to complete the oscillator tuned circuit. Condenser C is generally used for the oscillator series alignment condenser as well, while C2 is large and serves merely to complete the oscillator tuned circuit.

In studying this circuit, you should understand that the r-f voltage developed across the oscillator tuned circuit corresponds directly to the generator E_p in Fig. 62. The phase-shifting network is composed of R3 and C4, which corresponds to R and C in Fig. 63. Note that an additional blocking condenser C3 is shown in Fig. 65. This is necessary in order to isolate the d-c plate voltage from the control grid of the control tube. This blocking condenser is not shown in Fig. 63 because we were not concerned at that time with the d-c voltages in the circuit. The value of C3 is sufficiently great so that its reactance is low with respect to the resistance of R3, and hence it does not influence the operation of the phase-shifting circuit. Resistors R4 and R5 are in the AFC control voltage circuit and R6 establishes the fixed bias when there is no AFC control voltage. By making R4 high with respect to the reactance of C4, it does not disturb the phase shifting arrangement. The a-c voltage present across C4 and fed to the control-grid circuit of the control tube remains 90° out of phase with the voltage across the oscillator coil L1.

In closing this chapter we would like to state that it has been our aim to present a working knowledge of the control tube circuit, without any intention of entering upon a complete, mathematical explanation of the operation of the tube and a quantitative derivation of the exact impedance reflected under different conditions. Furthermore, we have not considered each and every modification of control circuits. These will follow in subsequent chapters and will be found to be based upon the fundamental explanation given in this chapter.

CHAPTER V

COMMERCIAL AFC CIRCUITS

HAVING discussed the general operation of discriminator and oscillator control circuits, we are ready for an examination of some of the commercial receivers which make use of automatic frequency control. You will find as you read this chapter, that certain references are made to performance details and special circuit modifications. It is important to view and accept these facts from the viewpoint that they are generally applicable, although they happen to be identified and discussed in connection with one particular receiver.

As a rule the circuits employed in commercial receivers are based on the general principles explained in the preceding chapters, but there are individual variations which will become evident as you progress through this chapter. The fact that we show comparatively few commercial AFC circuits should not be construed as signifying that no other receivers but those discussed employ AFC. By the time this book goes to press, many receivers not listed herein will employ AFC and within six months or a year of the date of publication, AFC will be a commonplace feature in American radio receivers. We want to emphasize especially that the circuit descriptions contained in this chapter are valuable not only in connection with the specific receivers described, but they are perhaps of even greater importance because they will help you to understand other circuits in use at the present time, as well as those which will make their appearance within the next few years.

AFC in G.E. Model E-101.

The AFC system used in this General Electric receiver, as shown in Fig. 66, is a commercial application of the principles discussed in connection with the basic discriminator and oscillator control systems. An examination of the discriminator arrangement shows it to be essentially the same as that described in connection with Figs. 27 and 31. Of course the complete diode load circuit differs from the arrangement shown in the figures mentioned, but this is to be expected because Fig. 66 also shows the AVC and audio circuits.

One modification of the discriminator network appears in Fig. 66. This is the use of the resistance-capacity filter

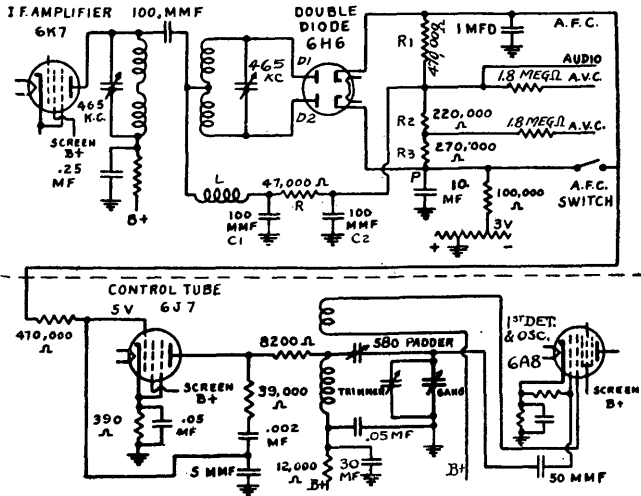

Fig. 66. The AFC circuit used in the General Electric Model E-101 receiver

R-C1-C2 in the common lead which joins the input and output circuits of the rectifier. The purpose of this filter is to keep i-f voltages and currents out of the diode load resistor circuit. You will note that the audio voltage is secured from the junction of the load resistors R1 and R2, making it necessary to include a filter ahead of this point. In the basic

discriminator circuits discussed in preceding chapters it was unnecessary to use such i-f filters, because the circuit arrangement was such as to permit the use of a large by-pass condenser at the junction of R1 and R2, thus effectively keeping the i-f out of the a-f amplifier.

In addition to supplying the AFC and a-f voltages, this discriminator is used to furnish AVC voltage. You will observe from the figure that three resistors are used to make up the diode load. The load resistor for the diode D1 consists of R1, while the load for the second diode D2 consists of two separate resistors R2 and R3. Two resistors are used for the load of the second diode so as to permit different degrees of AVC voltage to be fed to the i-f and r-f tubes. Essentially, however, this does not affect the AFC action—the circuit is still balanced.

The lower part of the discriminator load circuit appears to deviate from the circuits described previously. Normally, the lower end of the discriminator load circuit is returned to ground. However, you will note that in this receiver, this point P is by-passed to ground through a 10-mf condenser and returned to a point on the voltage divider which is 3 volts negative with respect to ground. This connection is made through a 100,000-ohm filter resistor, which, in conjunction with the 10-mf electrolytic, acts to prevent any hum or audio voltages from being fed into the discriminator circuit. As a result of this connection, the entire discriminator circuit is placed at a potential of 3 volts below ground. In this way an initial bias is fed to the grids of the tubes which are controlled through the AVC bus, so that it is unnecessary to use individual cathode resistors and bypasses for each controlled tube. Instead, the cathodes of the controlled tubes are connected directly to ground.

The high side of R1, you will see by reference to Fig. 66, is by-passed to ground through a 1-mf condenser. This condenser serves a two-fold purpose: it prevents hum and audio voltages from being fed to the oscillator control tube, and in addition increases the time constant of the AFC circuit so that it is greater than that of the AVC circuit.

The Control Tube.

The control circuit used in this receiver is essentially similar to that shown in Fig. 65. Note especially that the phase shifting network consists of a 39,000-ohm resistor and a 5-mmf condenser. Actually the 5-mmf condenser is in parallel with the control tube grid-to-cathode capacity plus the capacity of the wiring, so that the total capacity across which the lagging voltage is developed, is of the order of 20-mmf. The .002-mf condenser which is in series with the 39,000-ohm resistor, does not play any part in shifting the phase because of its large value and serves only to prevent the d-c plate voltage from reaching the grid of the oscillator control tube.

An 8200-ohm resistor is included between the plate of the oscillator control tube and the tuned circuit of the oscillator. This resistor is used primarily as a control on the variation of the AFC range at the various frequencies throughout the band.

A switch for shorting out the AFC action is incorporated in the circuit. When this switch is closed, the cathodes of the two diodes are joined together so that essentially the discriminator circuit becomes a conventional full-wave rectifier circuit. Note that under this condition the two diode loads are in parallel with each other and that therefore no AFC voltage is generated. However, the audio and AVC voltages are still produced just as they would be in the case of a conventional full-wave rectifier circuit.

In Fig. 67 the schematic of the AFC circuit used in the twelve and fifteen tube 1937 General Electric models is shown. You will observe that this circuit, with several exceptions, is quite similar to that just considered and used in the ten-tube model. With the exception of an additional resistor in the lower diode load circuit, which is used to supply the Colorama tube, the discriminator circuit is the same as that previously discussed. Note also that additional condensers of 250-mmf and 100-mmf capacity are used to bypass the diode cathodes. The purpose of these condensers is to provide more effective by-passing as far as the intermediate frequency and its harmonics are concerned. Incidentally, as we shall see later, it is sometimes necessary to remove the 1-mf

the AFC channel is made considerably broader than usual—without sacrificing the selectivity of the regular signal channel.

The Discriminator.

The discriminator used in this receiver is of the conventional type, the i-f choke in the secondary center-tap circuit being omitted and the center-tap returned directly to the midpoint of the load connected between the two cathodes (see Fig. 45). The high side of the discriminator load is by-passed to ground with a comparatively small condenser—.1 mf. However, the AFC voltage is fed to the oscillator control tube through a 3-megohm resistor which is by-passed to ground through a .02-mf. condenser. This filter, of course, has the effect of further increasing the time constant so that it is greater than that of the AVC circuit.

The Voltage-Limiting Diode.

Inspection of the schematic in Fig. 68 will show you that the AFC bus is connected to one of the diode plates in the 6R7 second detector and first audio tube. Since the cathode of this tube is 2.0 volts above ground, this diode will start to draw current whenever the positive AFC voltage produced by the discriminator exceeds 2.0 volts. This current will flow through the 3-megohm filter resistor, and the voltage drop across this resistor will prevent the voltage at the grid of the 6J7 control tube from rising appreciably above 2.0 volts.

There is, of course, no connection between the audio circuit and the AFC system. The fact that the AFC bus is connected to a diode in the first audio tube is purely a matter of convenience. The results and operation would be exactly the same if a separate diode with its cathode 2.0 volts positive with respect to ground were connected across the AFC bus.

This voltage-limiting diode is used for a definite reason. You will recall that in connection with a previous AFC circuit we mentioned that high values of positive grid voltage on the control tube cause this tube to reflect a low value of resistance (as well as inductance) across the oscillator tuned

circuit. As a result of this heavy damping, stoppage of the oscillator can sometimes take place. The use of the voltage limiting diode removes this possibility, since the grid of the control tube can never go positive enough to cause the oscillator to stop functioning.

As far as the oscillator is concerned, this much of the circuit is conventional; essentially, the same basic system described in Fig. 65 is used. The r-f voltage appearing across the tank circuit of the oscillator is fed to the plate of the 6J7 control tube in the conventional manner, so that the control tube obtains its plate voltage through the oscillator grid coil. Note that a different value of resistance is used in the phase shifting network for each of the three wave bands. These are respectively 100M, 50M and 20M ohms for the broadcast, police and amateur, and the short wave bands. While no condenser is used between the grid of the control tube and ground, actually there is sufficient capacity between the grid and ground due to the tube capacity and associated wiring (as indicated by C1) to provide the required capacity for shifting the phase.

The reason for the use of smaller values of resistance in the phase shifting network for the higher frequency bands becomes apparent when we consider that R1 must be large with respect to the reactance of C1 in Fig. 68, and at the same time must maintain a more or less fixed relation with respect to the reactance of C1 at the particular frequency of operation. Since the reactance of C1 is considerably less on the short-wave bands, it follows that the best performance is secured by using a progressively lower value of R1 on the higher-frequency bands. This problem was not encountered in the case of the other receivers discussed because these circuits are operative only in the broadcast band.

An interesting point about the oscillator control tube is that the bias for this tube is adjustable by means of a rheostat in the voltage divider circuit. This control is ordinarily not adjusted, except when the control tube is replaced or the receiver is being aligned. The most desirable control action is obtained when the control is set so that the bias voltage on the 6J7 is 4.8 volts. Because of the infrequent need for ad-

justment of this control, the receiver must be removed from the cabinet before the control is accessible.

AFC in Double Superheterodynes.

The double superheterodyne principle is quite old, and, as you may recall, was used in receivers quite a few years back. Its revival at this time in a number of current receivers is due to the fact that in connection with AFC it offers certain advantages. This will be brought out in the course of the following discussion. However, before we go into the application of AFC to the double superheterodyne, let us review briefly the manner in which the circuit functions.

As the name implies, a double superheterodyne is one in which the superheterodyne principle is applied twice in suc-

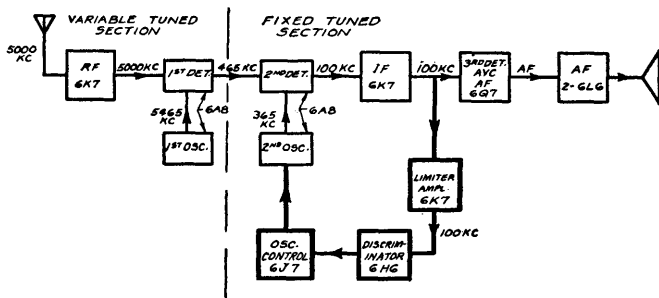

Fig. 69. The path of a 5000-kc signal through the Westinghouse WR-315 double-superheterodyne receiver is shown in this block diagram. The elements of the AFC system are indicated by the heavy lines

cession. In Fig. 69 we show the block diagram of a modern double superheterodyne, the Westinghouse Model WR-315 which is equipped with AFC. For the moment we shall disregard the components which are indicated in heavy black squares and consider the path of a signal through the receiver, without regard to any AFC action.

For the sake of clarity, we shall assume that the input signal to the receiver has a frequency of 5000 kc. As the figure shows, this signal is amplified in the first r-f stage, which uses a 6K7 tube, and is passed on to the first detector-oscillator

stage, which employs a 6A8. Here the 5000-kc signal is mixed with the 5465-kc frequency produced by the first oscillator, so that an intermediate frequency of 465 kc (5465-5000) is produced in the plate circuit of the first detector. Up to this point you will note that the action is identical with that which takes place in any ordinary superheterodyne.

The 465-kc frequency, you will observe from the block diagram, is not amplified in the ordinary manner, but instead undergoes a further frequency change in a second detector; this tube should not be confused with the conventional second detector. Here the 465-kc signal mixes with the 365-kc voltage generated in the oscillator section of the second 6A8 and, as a result, a second intermediate frequency equal to 100 kc is produced. From this point on, the new 100-kc intermediate frequency is amplified in the 6K7 i-f stage and finally detected in the 6Q7 stage, which also serves as the first audio stage and provides AVC voltage. Note that the 100-kc i-f signal is produced by a heterodyning signal of 365 kc. Normally, the heterodyning signal would be higher in frequency than the carrier, in this case the 465-kc signal. However, if this is done, then the heterodyning signal comes within the broadcast band. It would be 565 kc, and produce beat notes with various signals within the broadcast band, such as 560 kc and 570 kc. While it is true that beat notes may be developed when the heterodyning signal is 365 kc (between the harmonics of this signal and broadcast carriers), the situation is not as troublesome as would be encountered if the heterodyning signal were 565 kc.

To appreciate why this double superheterodyne circuit is used in connection with AFC, it is necessary to understand which circuits remain tuned to the same frequency regardless of the signal frequency being received, and which circuits must be tuned to correspond with the signal frequency being received. This is clearly shown in figure 69 and you will observe that all the circuits to the right of the vertical line are fixed tuned. On the other hand, the r-f, first detector, and first oscillator circuits are, of course, tuned in the conventional manner by means of a three-gang variable condenser. A further study of the block diagram will show you that

most of the selectivity in a receiver of this type resides in the final i-f system (100 kc), since four tuned circuits are associated with this frequency, while only two are associated with the 465-kc intermediate frequency, and these are purposely made broader than normal.

Because of the predominance of the receiver selectivity in the 100-kc i-f amplifier, whether the receiver is tuned correctly as a whole will depend upon whether the signal passes through the 100-kc i-f amplifier at 100 kc or at a frequency different from this—say 95 kc or 105 kc. Naturally an error in the tuning of the gang condenser in the variable-tuned section will upset the frequency of the signal passing through the i-f amplifier, since it will cause the first detector output to differ from 465 kc. This is the normal manner in which errors in tuning are introduced.

The important thing to note, however, is that a change in the frequency of the second oscillator, which normally operates at 365 kc, will also change the frequency of the signal passing through the 100-kc amplifier. That is, if the frequency of the oscillator is changed from say 365 kc to 369 kc, then the frequency of the second i-f signal will be changed from 100 kc to 96 kc. In other words, whatever change is made in the frequency of the second oscillator—which normally operates at a fixed frequency—is reflected as an equal change in the final intermediate frequency.

The significant thing about this is that AFC is made possible by controlling the frequency of an oscillator *which operates about a fixed frequency*. In the conventional superheterodyne, we saw that the AFC system in some of these receivers was operative only on the broadcast band, and that in others the constants of the oscillator control circuit had to be changed on the different bands so as to secure the desired degree of control over the entire frequency range covered by the receiver. This of course is due to the fact that the operation of AFC in these receivers is dependent upon controlling the frequency of an oscillator which tunes over an extremely wide range.

Essentially, then, the use of the double superheterodyne principle makes it possible to obtain a *uniform AFC action on*

all bands by controlling the frequency of the second oscillator—the fixed-frequency oscillator. Any error which may occur in the variable-tuned section, so that the signal going into the second detector is not exactly 465 kc, will be corrected by a change in the frequency of the fixed-frequency (365 kc) oscillator—with the result that the final output from the second detector will be the required 100-kc signal. . . .

The Limiter Amplifier Stage.

The block diagram in figure 69 shows the elements belonging to the AFC system in heavy black outline. The output of the last i-f stage is coupled to the grid of a so-called limiter amplifier stage which feeds the discriminator circuit. The control voltage produced by the discriminator is in turn fed to a 6J7 oscillator control tube which controls the frequency of the oscillator having a nominal frequency of 365 kc.

There are a number of points of interest in this system and for this reason we have drawn the circuit in some detail in Fig. 70. Beginning at the output of the last i-f (100-kc) stage, you will note that a 50-mmf condenser attached to the primary winding of the last i-f transformer, is used to feed the 100-kc signal into the grid of the tube called the *limiter amplifier*. You will observe that the limiter amplifier is essentially another i-f stage which amplifies the signal before it is fed into the discriminator circuit. Although this stage does not receive any AVC voltage, it operates to provide an essentially constant output at the discriminator. On weak signals the full gain of the stage is available to bring up the signal fed to the discriminator, while on strong signals, the flow of grid current through the one-megohm grid leak acts to limit the gain so that the output of the tube cannot exceed a certain value. In this way, a more uniform AFC action is obtained on weak as well as strong signals.

We need not comment on the discriminator circuit at this time, since we have already discussed it in a previous chapter (see Figs. 49 to 53). However, the oscillator control circuit incorporates a slightly different method for obtaining the 90° out-of-phase voltage which is required for the grid of the con-

employs a phase shifting network in parallel with the tuned circuit, while the present circuit obtains the required phase shift by the incorporation of a resistance in the oscillator tuned circuit itself.

Bear in mind that we are making no attempt to weigh the relative advantages of one type of circuit over those of another. We are interested primarily in setting forth the mode of operation of the circuits to be found in commercial receivers, so that you will be able to service these circuits efficiently.

Midwest 18-37.

The schematic of the AFC system used in a number of Midwest receivers, and specifically that used in the model 18-37, is reproduced in Fig. 71, because it embodies a number of interesting variations which have not as yet been covered.

Beginning at the oscillator stage you will note that a Colpitts circuit employing a split stator condenser is used, as indicated by C1 and C2 on the diagram. A shunt-fed circuit is employed, the plate voltage being applied to the 6C5 through a 50M-ohm resistor, while the feedback to the tuned circuit is through a .002-mf condenser. A 50-mmf condenser couples the oscillator voltage to the mixer grid of the 6L7 tube which is used as the first detector.

Turning our attention to the oscillator control stage, we note several features which are of interest. As in one of the other circuits, a combination of fixed and self bias is used on the 6J7 control tube, and the bleeder resistance connects from the junction of the two cathode resistors to the screen of the control tube. Of special interest in this connection is the tolerance specified for the 390-ohm cathode resistor which must be within the comparatively close value of 3%. The reason for the close tolerance of this resistor is that it carries the bleeder current and is therefore largely instrumental in determining the value of bias which is effective on the control tube. On the other hand the value of the 500-ohm cathode resistor is not nearly so critical and bears the usual tolerance of 10 or 15%. Where it is necessary to replace the

other bleeder resistance of 15M-ohms (between the screen and the junction of the two cathode resistors) it is desirable to use a resistor having a tolerance of 5 or at most 10 per cent, since this resistor is also effective in determining the bias on the control tube. For example, a 5% error in the 15M-ohm bleeder resistor will cause approximately a 5% error in the voltage drop across the 390-ohm resistor much in the same way that a 5% error in the 390-ohm resistor will cause the

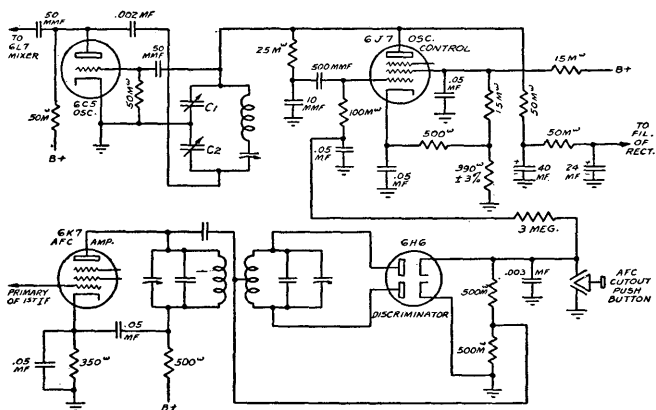

Fig. 71. The AFC circuit employed in the Midwest Model 18-37 receiver. Note the special filter supplying the plate voltage to the oscillator control tube only. A Colpitts oscillator circuit is employed and a conventional discriminator circuit

same error in the voltage drop between the same two points.

As far as the grid excitation of the control tube is concerned, you will observe that the r-f grid voltage is obtained through the phase shifting network consisting of a 25M-ohm resistor and a 10-mmf condenser. The 500-mmf condenser serves as the grid blocking condenser, while the AFC voltage is fed to the grid through a 100M-ohm resistor.

The control tube is shunt fed through a resistor rather than through an r-f choke. Note also that the plate voltage of the control tube is obtained through a special resistive-

capacitive filter circuit which supplies only the control tube plate voltage and no other. The reason for this special arrangement is to avoid interaction between the oscillator frequency—as determined in part by the d-c plate voltage on the oscillator control tube—and the amount of audio output. The latter influences the oscillator frequency because the output of the ordinary power supply fluctuates in accordance with the plate current demand of the audio output tubes. Ordinarily, as explained in detail in Chapter VII, the effect of this interaction is to set up an unstable condition which is often accompanied by motorboating. By connecting the filter directly to the filament of the rectifier tube, the voltage drop across the filter choke no longer affects the voltage which is applied to the plate of the control tube and therefore this tendency toward motorboating is avoided.

The discriminator circuit used in this receiver is quite conventional, being of the type which does not require an i-f choke. Since a separate detector and AVC circuit is used, no taps are in the discriminator to supply audio and AVC voltages. The AFC voltage is applied to the control tube through a 3-megohm resistor which is by-passed at the control tube end by a .05-mf condenser.

The AFC amplifier circuit used in this circuit makes use of a separate tube to feed the discriminator. This tube receives its i-f voltage from the primary winding of the second i-f transformer and is controlled by the AVC system. Since two i-f stages are in this receiver, the plate circuit of the AFC amplifier stage is filtered to avoid the possibility of feedback and oscillation. This is the function of the 500-ohm resistor and the .05-mf condenser.

AFC in G.E. Model FA-80.

An example of the application of AFC in automobile radio receivers is illustrated in the G.E. FA-80 circuit shown in Fig. 72. Turning our attention to the discriminator circuit used in this receiver, we note a number of interesting variations. A 100M-ohm resistor is used to replace the i-f choke which is used at this point in the G.E. home receivers, while an

i-f filter consisting of a 47M-ohm resistor and two 250-mmf condensers prevents the i.f. from reaching the junction of the two 510M-ohm discriminator load resistors. The audio voltage is taken from this point and it is consequently necessary to filter out the i-f signal voltage so as to prevent this from getting into the a-f amplifier.

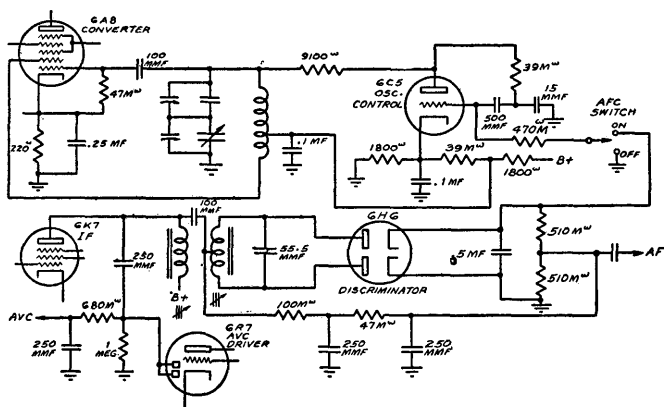

Fig. 72. The AFC circuit used in the General Electric Model FA-80 auto receiver. An iron-core discriminator transformer with a self-tuned primary and a triode oscillator control circuit are employed

Permanence of the discriminator tuning adjustment presents a considerable problem in AFC design for auto radio receivers, since a slight change in the alignment of the discriminator circuit will result in extremely poor operation of the receiver and an especially low signal-to-noise ratio. These problems have been successfully solved in the G.E. FA-80 receiver by using an iron-core discriminator transformer and a special type of fixed trimmer condenser. The inductance of the primary and secondary windings is tuned by movement of the iron cores and the transformer assembly is designed so that even extreme vibration will have no effect upon the inductance value. The primary winding is self-tuned, there being no trimmer condenser—while the secondary winding is

tuned by a special 55.5-mmf trimmer condenser. This trimmer condenser consists of a single strip of mica which is silver plated on both sides, the plating forming the two electrodes of the condenser. Capacity variations due to temperature, humidity, and aging are reduced to a minimum through this form of construction so that permanence of the discriminator alignment is assured.

It is worth mentioning that the discriminator does not supply the AVC voltage. The latter is secured from a diode, but a separate AVC diode, which receives its voltage from the primary winding of the discriminator transformer, is used. The 250-mmf coupling condenser feeds the signal into the diode section of the 6R7 driver, while a 1-megohm resistor serves as the diode load. This arrangement makes it possible to obtain reduced selectivity in the AVC circuit.

The oscillator is conventional and requires no special comment. As to the oscillator control stage, several interesting features are evident. To start with, a triode is used in place of the conventional screen grid tube. In accordance with usual practice, the plate of the oscillator control tube is connected to the oscillator tuned circuit through a limiting resistance of 9100 ohms, which has the further purpose in this receiver of preventing the control tube from seriously damping the oscillator tuned circuit for high positive values of AFC voltage. The phase shifting circuit consists of a 39M-ohm resistor in series with a 15-mmf condenser across the grid-to-cathode capacity of the control tube. As a result of the lagging r-f voltage which is thus applied to the grid of the control tube, the triode plate circuit appears to the tuned circuit of the oscillator as a variable inductance the magnitude of which changes in accordance with the AFC voltage applied to the grid of the control tube. The remainder of the circuit is quite conventional.

Grunow Models 12B, 12W.

The essential portions of the AFC circuit used in this receiver are shown in Fig. 73. Starting at the plate circuit of the second i-f tube, you will note that this is coupled to the

two diodes of the discriminator through a conventional split-secondary discriminator transformer. Since an i-f choke is not used in the discriminator, the junction of the two diode loads is not by-passed. The load resistance of the lower diode is in two sections, consisting of a 330M-ohm resistor and a 150M-ohm resistor. The function of these two resistors is to supply the proper amount of AVC voltage as well as the audio voltage. Since we are not especially interested in the a-f system at the moment, the tone compensating network,

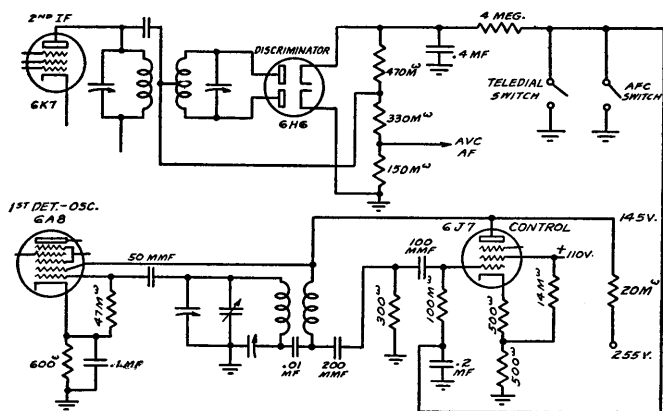

Fig. 73. The AFC circuit of the Grunow Model 12-B receiver. The discriminator circuit is conventional, but the control tube circuit differs from those previously discussed

including the volume control, is omitted in this abridged schematic. In accordance with usual practice, the cathode of the upper AFC diode is by-passed to ground with a rather large condenser, in this case .4 mf. The AFC voltage developed at this point is fed over to the grid of the 6J7 control tube through a 4-meg resistor which is by-passed to ground at the control grid end by a .2-mf condenser.

Two switches are provided across the AFC bus, one of which is designated as the AFC switch, while the other is called the *Teledial* switch. The purpose of the AFC switch is to short the AFC bus so that the AFC action can be

eliminated when it is desired to have manual operation of the receiver. The *Teledial* switch, on the other hand, is mounted directly on the dialing mechanism, and functions to short the AFC voltage momentarily, when the index pin associated with the particular station being tuned strikes the stop pin. In this way the AFC system is made to take control of the signal on the desired channel and is prevented from holding a considerably stronger signal on an adjacent channel in preference to the desired signal.

The control tube circuit has several unusual features which merit mention. With reference to the arrangement of the 6J7 circuit, you will note that a combination of fixed- and self-bias is used. The self-biasing action is secured by returning the cathode of the 6J7 to ground through two 500-ohm resistors, while the fixed bias effect is obtained by connecting a 14M-ohm resistor from the 110-volt tap on the voltage divider (screen of the 6J7) to the junction of the 500-ohm resistors. Since self-biasing of the control tube makes for stability and independence of tube and voltage characteristics, while fixed bias increases the sensitivity of the control tube action (because degeneration due to the voltage drop across the cathode resistor is reduced), the combination of these two bias arrangements makes it possible to obtain a stable control tube action without undue sacrifice of control tube sensitivity.

Turning our attention to the oscillator circuit, we note that a 6A8 tube is used. The coupling to the control tube is different from the circuits which we have previously discussed, in that the plate of the 6J7 control tube is connected across the feedback circuit of the oscillator rather than across the grid winding. For this reason it follows that the reflected reactance of the control tube is shunted across the feedback circuit rather than across the tuned circuit. The excitation to the control grid of the control tube is obtained by coupling the control grid to the r-f voltage present across the series oscillator padder through a network consisting of a 200-mmf condenser and a 300-ohm resistor. The final voltage applied to the control grid is the voltage across the 300-ohm resistor.

The phase relations existing across the various portions of this circuit through the band are rather complicated, but this much can be said: that the object of the unusual circuit arrangement is to secure as uniform a control action as possible over the broadcast band.

More specifically the phase relations are as follows: the reactance of the series padder is small in comparison with that of the primary coil and therefore the current through this branch lags the voltage across the tuned circuit by nearly 90° . The voltage across the series padder lags this current by 90° , bringing it 180° out of phase with the tuned circuit voltage. Since the reactance of the 200-mmf condenser is large in comparison with 300 ohms, the current in this circuit leads the voltage across the padder by nearly 90° and therefore the voltage at the grid of the 6J7, which is in phase with this current, lags the tuned circuit voltage by approximately 90° .

Although this receiver has three bands, we have omitted the band switching arrangement and have shown only one band. Since the AFC system functions only on the broadcast band, this procedure is entirely justified.

Grunow Model 15W.

The discriminator circuit employed in this receiver is essentially the same as that used in the Model 12B, so that to avoid duplication of material we have shown in Fig. 74 only the oscillator and oscillator control circuits which use a somewhat different circuit.

Turning our attention to the grid circuit of the control tube, we note that the tube receives its r-f excitation directly from the r-f voltage present across the oscillator grid coil. Note, by the way, that the oscillator coil is tapped and connected to the cathode, so that feedback is provided through the cathode circuit and the need for a separate tickler winding is eliminated. The phase shifting network in the grid circuit consists of a 75M-ohm resistor in series with a 10-mmf condenser, the capacity of the latter being increased by the normal grid-to-cathode capacity of the tube and associated wiring.

84 AUTOMATIC FREQUENCY CONTROL SYSTEMS

In contrast to the other control tube circuits which we have presented, the plate of the control tube is shunt fed through an r-f choke, the inductance of which is fairly high in comparison with the inductance of the oscillator grid coil. The variable inductance, which is built up across the plate circuit of the control tube because of the lagging grid excitation, is coupled to the tuned circuit of the oscillator through a .001-mfd condenser, as shown in Fig. 74.

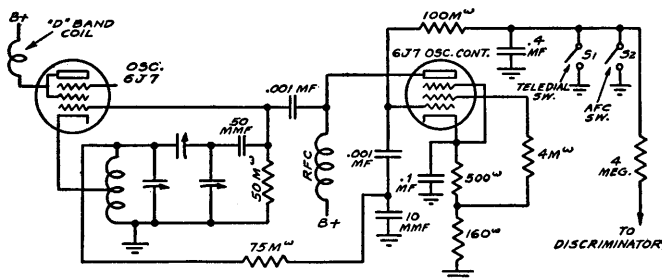

Fig. 74. The oscillator and oscillator control tube circuit of the Grunow Model 15-W receiver. Note the r-f choke in the plate circuit of the oscillator control tube

Note that with this arrangement it is unnecessary to maintain the grid coil of the oscillator above ground by the amount of plate voltage needed for the control tube. The operation of the Teledial and AFC switches is in accordance with the facts given in connection with the Model 12B receiver.

RCA Model 812K.

This receiver is interesting because it combines the features of AFC with those of the automatic tuning systems which were used on a number of receivers several years ago. In discussing the system employed, we shall first consider the AFC circuit, which is quite conventional, and then later we shall discuss the tuning condenser motor drive. The latter arrangement makes it possible to tune in a desired station automatically, merely by pressing the appropriate push button. As we explained briefly in the opening chapter, although the AFC circuit functions independently of the motor drive, it is

slightly from the arrangement there shown, in that an additional winding L23 is used to resonate the input circuit to the i-f peak.

At first glance it might appear that the tuning of the discriminator secondary could be accomplished by the movement of the iron core of L22. Actually, however, it is the function of this iron core to balance the two windings, so that each diode section of the discriminator transformer receives the same amount of inductively coupled i-f voltage. The adjustment of L22 is therefore permanently set at the factory and ordinarily is not to be changed. The auxiliary winding L23, which is in shunt with L22, makes it possible to vary the total inductance in the final tuned circuit of the discriminator transformer and hence to peak this circuit correctly. Note that the movement of the core of L23, which is necessary to obtain the proper tuning adjustment, does not influence the balancing of the circuit, since the latter remains fixed by the position of the iron core in L22.

Of interest is the use of fixed trimmer condensers throughout the i-f amplifier and discriminator, the tuning of the several circuits being in every case accomplished by movement of the iron cores associated with each of the i-f coils.

Turning our attention to the oscillator and oscillator control circuits, we note that a 6J7 with the screen and plate tied together is used as the oscillator tube. Both for reasons of simplicity and because the AFC circuit is inoperative on all bands except the broadcast band, the wave-band switch connections have been omitted, and the circuit for the broadcast band shown. Feedback for the oscillator is accomplished through the coil L13 in the cathode circuit, while the iron-core coil L-14 serves as the oscillator grid coil. The r-f voltage appearing across the oscillator coil is fed over to the grid of the 6J7 oscillator control tube through a 470-mmf condenser and a 120M-ohm resistor. This latter resistor, in combination with the grid-to-cathode capacity of the control tube, forms the phase shifting network to supply the lagging grid voltage. It may be noted that the 2-20 mmf condenser shown in the diagram functions to trim the oscillator at the

high-frequency end. The adjustment of the oscillator tracking at the low-frequency end of the broadcast band is accomplished by varying the inductance of L14, by moving its iron core.

In addition to supplying AFC voltage, the discriminator supplies voltages for the tuning indicator, the AVC system, and the audio amplifier. The tuning indicator voltage and the AVC voltage are taken from the junction of the two discriminator load resistors and passed on to the appropriate points through suitable resistor-condenser filters, so as to prevent interaction between the circuits and to provide the proper time constants, as discussed elsewhere in this book.

An interesting feature of the circuit arrangement is that the minimum bias voltage for the controlled tubes is supplied through the AVC feed line. This is secured by returning the AVC feed line to a point on the voltage divider which is 10.5 volts negative with respect to ground, and provides a minimum bias of approximately 3 volts to the several controlled tubes. The circuit arrangement is such that the discriminator functions in a normal manner and is not interfered with as a result of this negative bias voltage.

"Electric Tuning" Circuit.

The electric tuning mechanism which provides automatic push button tuning in combination with AFC, consists essentially of a quick engaging and disengaging reversible electric motor, tuning condenser driving gear train, and eight mechanically interlocked—pushing one button releases all the others—station selector push buttons. These push buttons are wired respectively to eight adjustable station selector contactor discs (each with a motor-stopping insulated segment) mounted on a drum which is direct-coupled to the gang tuning condenser shaft. The arrangement permits any one of eight pre-determined stations to be tuned in electrically by merely touching the correct button.

We shall describe the operation of the circuit by reference to the skeleton diagram shown in Fig. 76, which shows the basic operation of the system employed to obtain electric tuning. Referring to the figure, you will note that a 24-volt

88 AUTOMATIC FREQUENCY CONTROL SYSTEMS

winding on the power transformer supplies voltage to the motor which drives the tuning condenser. The circuit is completed through push buttons normally in contact with metal discs, which are indicated in the figure as "Station Selector Discs." Actually eight of these discs and push buttons are used in the receiver, but only two are shown in the figure, so as to simplify the diagram.

The motor reversing switch shown in Fig. 76 is arranged so that when the tuning condenser reaches the two limits of its rotation, that is, minimum and maximum capacity, the switch is thrown from one side to the other so as to reverse the direction of rotation of the motor. This is accomplished

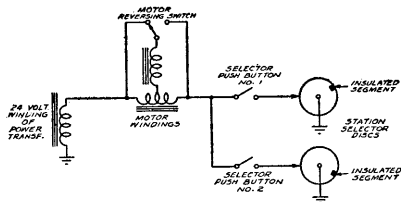

Fig. 76. A simplified circuit of the push-button tuning system employed by RCA in those receivers with motor-driven tuning condensers

by mounting the reversing switch on the tuning condenser shaft, and linking the switch mechanically so that a lever trips the switch when the condenser approaches either a fully meshed or unmeshed position. Suppose we assume for the moment that push button No. 1 is depressed. This completes the circuit, since a continuous path to ground is provided through the push button No. 1 and the station selector disc No. 1. Thus the motor will rotate and turn the tuning condenser, until the contact on the disc reaches a point which carries an insulated segment. At this point the motor circuit is opened, and the motor stops. Since the disc is pre-set on the shaft to correspond to a certain station, the receiver is now tuned in to that station.

The function of the reversing switch will be more clearly understood from the following consideration. Suppose that the receiver is tuned so that when the push button corresponding to the desired station is depressed, the motor rotates the tuning condenser *away from* the station in question. In

this case the motor will rotate the condenser until it is completely meshed or unmeshed. At this point the reversing switch will be mechanically tripped, and the motor will rotate in the opposite direction until the insulated segment on the appropriate contactor disc is encountered. At this point the motor circuit is again broken, the motor comes to rest, and the desired station is tuned in.

Although only two station selector discs and push buttons are shown in Fig. 76, a study of the circuit will make clear that any number of additional stations can be tuned in electrically by adding additional selector discs and push buttons in parallel with the two which are shown. In every case, each station selector disc must be pre-set so that its insulated segment is under the contactor arm, when a station corresponding to the selector disc is accurately tuned in.

The circuit arrangement used in this receiver lends itself readily to remote control tuning with a minimum of circuit complications. Referring to Fig. 77, a further elaboration of the basic circuit is shown, indicating how it is possible to

Fig. 77. The addition of remote control tuning to the system of Fig. 76 is here shown in simplified form

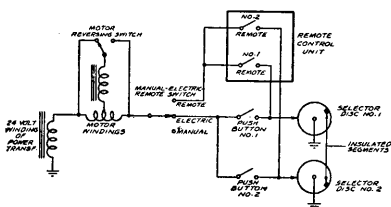

provide remote control operation. A separate remote control box, which contains a set of push buttons identically similar to those mounted on the receiver, is connected to the receiver through a cable of appropriate length.

A three point switch is mounted in the receiver which makes possible either "Remote," or "Manual" operation of the receiver. When the switch is thrown to the "Electric" position, the circuit of Fig. 77 becomes identical to that explained in connection with Fig. 76. When the switch is thrown to the "Remote" position the circuit is still the same as the circuit of Fig. 76 with the exception, of course, that the push

whenever the selector push buttons are not depressed. However, as soon as a button is depressed (with the switch in "Electric" position), the motor circuit is completed through the station selector contact disc; as the motor starts, the armature is drawn forward because of solenoid action. In this way, the pin F on the end of the shaft is made to engage the tuning mechanism, so as to drive the tuning condenser. At the same time that the driving mechanism is engaged, the forward movement of the shaft grounds the contacts E and D (see Fig. 78). As is shown in the diagram, these contacts are connected to the AFC diode cathode and the arm of the volume control. As a result, the receiver is completely inoperative while the motor is rotating and the station is being tuned in. In addition, the AFC circuit does not function, because the AFC output is grounded. The first feature, of course, provides completely quiet tuning and effective interstation noise suppression, while the latter feature insures that the AFC circuit will take hold on the proper channel rather than on some adjacent channel, as explained elsewhere in this book.

The "Manual-Electric-Remote" switch, one section of which was shown in Figs 76 and 77, appears somewhat more complicated in Fig. 78, in that it contains three sections, instead of just one. The reason for the additional sections is not difficult to understand. In the first place, the section in the upper left-hand corner corresponds to the section appearing in Figs. 76 and 77, and as we saw there, it functions to connect the motor to either the remote or receiver selector push buttons, or to disconnect the motor entirely when the switch is in the "Manual" position. The second or right-hand section of this switch is used to light the proper indicator bulb, depending upon the position of the switch. The third and lower section of this switch is merely an AFC switch. As you will note from the switch connections, this section connects to the AFC diode and shorts the discriminator output whenever the switch is in the "Manual" position. It follows, that the AFC circuit operates only when the electric tuning feature is used, and that it is inoperative when the receiver is tuned manually.

We have now completed a description of all the elements in Fig. 78. While the circuit appears considerably more complex than the elementary circuits shown in Figs. 76 and 77, this is in large part due to the complete sets of eight push buttons which are shown and the various connecting cables. If you have difficulty in following Fig. 78, we suggest that you use the preceding figures as a basis for tracing the connections.

Before leaving this receiver, we want to emphasize that the electric tuning features and the AFC circuit in this receiver, as in all others which incorporate like systems, are essentially complementary systems. Thus, whereas it is the function of the motor drive to tune in the selected station to within a few kc, which is the accuracy imposed by mechanical limitations, it is the function of the AFC circuit to correct for the errors in tuning, and hence to provide distortionless reception. Essentially, the function of AFC in both electric and manual systems of tuning is the same. In the case of the one system, AFC corrects for errors in tuning introduced by the mechanical limitations of the motor drive, while in the other case, AFC corrects for errors in tuning which are introduced by the operator in tuning in the station by hand.

While space is not available in this book to describe completely the rather elaborate system of gears and other mechanical linkages necessary to carry out the operation as described above, it is in order to point out the need for proper adjustment. The complete procedure for adjusting these receivers will be found in the manufacturer's service notes (published in full in Rider Manuals) and these should be carefully followed. Of special importance is the need for the proper adjustment of the station selector disc, so that each contactor will be properly centered over the appropriate insulated segment, when the receiver is accurately tuned to the selected station. Failure to observe this precaution may lead to adjacent channel interference, and possible intermittent loss of control by the AFC circuit.

The Push-Pull Discriminator and Control Circuit.

It is not surprising to find that the push-pull principle has been applied to automatic frequency control, when we consider the great many other circuits in which it has been used successfully.

The block diagram in Fig. 79 shows the arrangement of

Fig. 79. A block diagram showing the essential parts of a push-pull AFC circuit

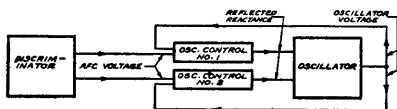

the components in a push-pull AFC circuit. Note that two oscillator control tubes are used and that the circuit is otherwise similar to the conventional AFC circuit. For reasons which we shall explain later on, both grids of the oscillator control tubes are excited in phase with respect to each other, and the lagging voltage which is required to make these tubes appear either as an inductance or capacitance across the tuned circuit, is obtained from a suitable point in the oscillator circuit. This is indicated on the diagram which shows a voltage being fed back from the oscillator circuit to each of the oscillator control stages.

Before we go into more detail as to the actual mode of operation, it is convenient to refer to a more complete circuit, and for this purpose, we shall analyze the operation of the AFC system used in the Philco Model 37-116, which is shown in Fig. 80. This receiver employs a push-pull AFC circuit in which the AFC is operative on all the wave bands.

In tracing the operation of this circuit let us begin at the output of the second i-f stage. As the figure shows, an untuned winding on the i-f transformer feeds the i-f signal into a separate i-f stage, which functions to amplify the voltage fed to the discriminator. The center-tap on the secondary of the discriminator transformer winding is returned directly to the junction of the two 490M-ohm load resistors, and since no i-f choke is used, this junction is not by-passed. Note further that the cathodes of the two diodes used in the discriminator are each by-passed symmetrically to ground. This

N, which feeds the other control tube, is negative. (In this simple illustration we have assumed that the batteries have no internal resistance; this assumption is justified because the principle of operation remains the same regardless of the value of internal resistance.)

Similarly, if the receiver were detuned by the same amount in the reverse direction, then the relative voltages across R1 and R2 would also be reversed, so that point M would become 5 volts negative with respect to ground, while point N would become 5 volts positive with respect to ground. In other words, the relative polarity of the voltages supplied to the two control tubes is reversed on either side of resonance. Fig. 82 indicates the reversal of polarity which takes place when the receiver is detuned by an equal amount in the reverse direction.

For the case in which the receiver is tuned accurately, there is of course no net voltage in the circuit, so that points M and N are both at ground potential, and therefore zero control voltage is fed to each oscillator control tube. It is now clear why it is necessary to use the two additional re-

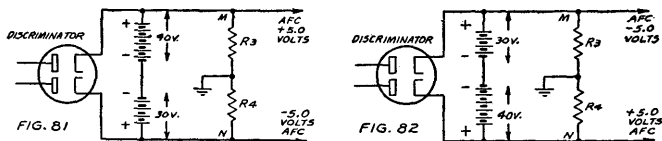

Figs. 81 and 82. The action in a push-pull discriminator circuit is here indicated when the receiver is detuned above resonance, Fig. 81, and below resonance, Fig. 82. The diode load resistors have been replaced by batteries to simplify the explanation

sistors R3 and R4 in order to obtain this symmetrical division of AFC voltage.

Continuing with the complete circuit shown in Fig. 80, you will note that two additional filter resistors are used in each leg, and that a .8-mf condenser is shunted across the two AFC leads. The purpose of this condenser is to remove the audio voltage and at the same time to increase the time constant of the AFC circuit. In addition to the .8-mf condenser, there is an additional .1-mf condenser from each AFC

lead to ground. The grids of the oscillator control tubes are each connected to their respective AFC lead through a 99M-ohm resistor. This connection provides the only d-c return path for the grids of the control tubes.

As a result of the connections which we have explained up to this point, the control tubes (the two triode sections of the 6N7G) receive an AFC voltage from the discriminator, which corresponds to the condition of tuning of the receiver. Before the oscillator control circuit can function, however, it is necessary to feed an out-of-phase voltage from the oscillator to the grids of the control tubes. In this way the plate circuits of the control tubes are made to appear to the oscillator tuned circuit, across which they are connected, as variable reactances. This was explained fully in the chapter on oscillator control circuits. The out-of-phase voltage for the grids of the control tubes is obtained from the oscillator circuit in the following manner.

You will observe that the plate of the 6A8G oscillator tube is connected to ground through a so-called *control impedance* which has a different value for each of the wave bands. On the broadcast band this control impedance takes the form of a series tuned circuit which is permanently tuned to 2650 kc. The d-c plate voltage is fed through a 10M-ohm resistor which as far as r-f is concerned shunts the control impedance through a .05-mf condenser. The oscillator plate current flowing through this capacitive control impedance develops an r-f voltage across this impedance. On the short-wave bands, the control impedance is still capacitive, but consists of a condenser, rather than a complete series tuned circuit. This r-f voltage is fed to the two control grids through the two 250-mmf condensers and is of such phase that it lags the voltage across the oscillator tuned circuit by 90° . The 99M-ohm filter resistors prevent the short circuiting of this r-f voltage by the filter condensers.

At first glance it might seem that each of the control tubes appears to the tuned circuit as a reflected inductance, which is what we found to be the case in the single oscillator-control-tube circuit. However, you will note that the plates of the two tubes are connected across points in the tuned circuit

which are 180° apart in phase, with the result that one tube draws a lagging current while the other control tube draws a leading current *with respect to the voltages at the points across which they are respectively connected*. As a result of these connections, one tube appears to the tuned circuit as an inductance—and therefore tends to raise the frequency of oscillation, while the other tube appears as a capacity—and therefore tends to lower the frequency of oscillation.

In the special case where the receiver is accurately tuned, the d-c grid voltage at each tube is equal to zero. It follows that the bias on each tube is equal to the common cathode voltage, and therefore the amount of reflected capacitive reactance is exactly equal to the amount of reflected inductive reactance. For this reason the frequency of the oscillator is not changed because the tendency of the one control tube to speed up or raise the frequency of the oscillator is exactly cancelled by the tendency of the other control tube to slow down or lower the frequency of the oscillator.

Suppose, however, that we take the case in which the receiver is detuned on one side of the correct setting, and that as a result a positive control voltage equal to 5 volts is applied to the grid of control tube No. 1, which reflects an inductance across the oscillator tuned circuit. At the same time a negative voltage equal to 5 volts is applied to control tube No. 2 which reflects a capacity across the oscillator tuned circuit.

As you know from a previous chapter, the effect of a decrease in bias (a more positive bias) is to produce a smaller amount of reflected reactance, regardless of whether this happens to be inductive or capacitive in nature. In this case, then, the positive voltage on the grid of control tube No. 1 will make this tube reflect a smaller value of inductive reactance across the tuned circuit, while the negative voltage on the grid of control tube No. 2 will result in an equal increase in the reflected capacitive reactance across the tuned circuit. In other words, as a result of the AFC voltage produced by the detuned condition of the receiver, the one tube reflects *a smaller amount of inductance*, while the other tube reflects *a smaller amount of capacity* across the tuned circuit. Both

of these actions tend to increase the frequency of the oscillator. In other words, a true push-pull action is obtained, in that the equilibrium, which exists when no control voltage is applied, is upset and each tube helps to raise the oscillator frequency until it is brought to the correct value.

Similarly, if the oscillator frequency happens to be too high instead of too low, then the AFC voltage applied to the control tubes causes the amount of reflected inductance to increase, and the amount of reflected capacity to increase. Again, both of these actions combine to lower the frequency of the oscillator to the correct value.

While the push-pull circuit is more complicated than the single tube type, it offers certain advantages. Thus, when the AFC action is shorted out by means of the switch which connects the two AFC leads to ground, the frequency of the oscillator is not affected by the actual value of the d-c cathode and plate voltages applied to the oscillator control tubes.

For example, any change in the grid bias voltage (the voltage drop across the 6N7G cathode resistor), or in the plate voltage, affects both control tubes to the same extent, so that there is no change in the frequency of the oscillator and in the calibration of the receiver. For this same reason, the push-pull control circuit is less susceptible to frequency modulation, and the consequent introduction of hum into the audio output as a result of hum voltages in the control tube circuit.

Push-Pull AFC Using the Pentagrid Converter

In Philco receivers which use a 6A8G as a combined first detector and oscillator, a modified type of control circuit is used. The complete AFC circuit shown in Fig. 83 and used in the Philco models 37-9, 37-10 and 37-11, is typical of this arrangement.

Note that the discriminator circuit is essentially the same as that just described in connection with the model 37-116. As far as the control circuit is concerned, however, there are a number of points of difference. In the first place, the out-of-phase oscillator voltage is obtained from the 85-ohm resistance in series with the low-frequency oscillator padder.

This is fed to the grids of the 6N7G through the two 110-mmf condensers.

This voltage is amplified in the two sections of 6N7G, and as a result of the inductive coupling between L1 and L2-L3, a positive or negative reactance (an inductance or capacitance) is reflected into the tuned circuit so as to control the frequency of oscillation. In the special case where the receiver is tuned accurately, and the AFC voltage is zero, the r-f current through L2 is exactly equal to that through L3. Since these currents flow in opposite directions through the two halves of the plate winding, the voltage induced in L1 by L2 is exactly cancelled by that induced by L3, so that the oscillator frequency remains unchanged.

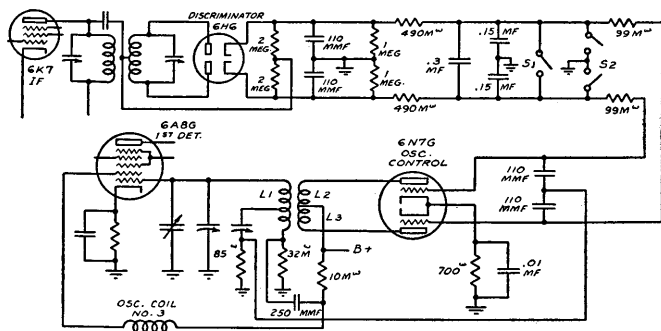

Fig. 83. The AFC circuit used in the Philco Models 37-9, 37-10, and 37-11

However, when the bias voltages are different (due to inaccurate tuning), the r-f current through L2 is different from that through L3, so that inductance or capacity is reflected into the oscillator tuned circuit. In this way, the oscillator frequency is returned to a value which corresponds to correct tuning.

The reason for the use of two switches in the discriminator circuit requires some comment. The switch designated as S2 shorts each of the AFC leads to ground and is used whenever it is desired to turn off the AFC action. On the other hand, S1 is contained in the automatic tuning dial and is so

arranged that the two AFC leads are shorted momentarily, just as the tuning condenser is brought to the proper position. In this way, the control voltage is not applied to the control tube until the tuning condenser has reached the proper position, so that the automatic frequency control will lock the oscillator frequency on the proper channel and not on some adjacent channel. If this switch were omitted, there would be a possibility of the AFC taking control of the oscillator frequency and locking it so as to receive a considerably stronger signal on an adjacent channel.

Flash Tuning.

The tuning system used in certain Sears-Roebuck receivers is of interest. The AFC circuit which is used in these receivers is itself quite conventional, but the tuning arrangement makes use of a system of call letters which are disposed around the outer circumference of the dial and which become illuminated as the station is tuned in. The conventional knob arrangement is used for tuning purposes. The name "Flash Tuning" originates of course from the fact that the call letters "flash" or become illuminated as the station is tuned in.

The heart of the tuning system is a semicircular toothed disc which is fixed to the chassis. Referring to Fig. 84, you will note that the teeth on this disc engage a small rounded projection which is fastened to a flat spring arm. Thus as the tuning knob is rotated, the projection or contact on the spring arm moves over the teeth on the semicircular disc. As the figure shows, not all the teeth on this disc are bent up so as to engage the contact on the spring arm, but only those are bent up which correspond to the position of the tuning condenser for the stations selected for Flash Tuning.

A simplified diagram of the basic circuit used is shown in Fig. 85. The heater winding on the power transformer is connected in series with a flash tuning light and the primary winding of a step-up transformer, which is designated as the AFC transformer. The toothed disc and contact arm, which have just been described, are connected across the primary winding of the AFC transformer so that when the contact

arm engages one of the bent-up teeth, the primary winding of the AFC transformer is short circuited.

The operation of the circuit is as follows: When a station which has been set up for Flash Tuning is tuned in, the contact arm engages the toothed disc so that a current flow through the flash tuning lamp takes place, since the contact completes this circuit to ground through the toothed disc. In addition to lighting the flash tuning lamp, the contact arm short circuits the primary winding of the AFC transformer so that no voltage appears across this transformer.

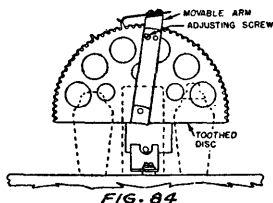

FIG. 84

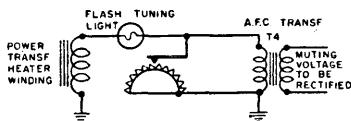

FIG. 85

Fig. 84. The bent-up teeth of the semi-circular toothed disc engage the contact on the movable arm, which is attached to the condenser shaft. When this contact is made the flash tuning circuit is closed, lighting the lamp that travels with the arm and so illuminating the call letters of the station to which the set is tuned

Fig. 85. A simplified diagram of the Sears-Roebuck flash tuning system. The muting effect is explained in the text

On the other hand, between the teeth which are bent up, that is, between the stations which are set up for Flash Tuning, the full voltage of the heater winding appears across the primary winding of the AFC transformer, since the impedance of the primary winding is high in comparison with the resistance of the lamp. As a further consequence of the high impedance of the primary winding, the bulb does not light except when the contact arm engages one of the grounded bent-up teeth. With the full heater voltage impressed across the AFC transformer, this voltage is stepped up and finally rectified by one of the diode sections of the first a-f tube, a 6Q7G. This diode voltage of approximately 60 volts is applied to the suppressor grids of the r-f and i-f tubes and to the control grid of the second a-f tube to pro-

vide interstation noise suppression or muting. Note that this muting action is removed as soon as a station set up for flash tuning is tuned in, since the toothed disc and contact arm short circuit the primary so that no muting voltage is developed.

The muting circuit functions only when the receiver is set for Flash Tuning reception. Under normal operating conditions, a section of the Flash Tuning switch removes the blocking voltage so that it is possible to receive other stations besides those set up on the toothed disc.

You will recall that we mentioned in the case of automatic dial tuning arrangements that an auxiliary switch is provided on the dial assembly so as to short circuit the AFC voltage momentarily as the station is tuned in. The purpose of this arrangement is to prevent a strong station on an adjacent channel from taking control of the oscillator and preventing the reception of the desired station. In this same connection the muting circuit described here accomplishes the same purpose automatically. When the receiver is being tuned, the muting action not only blocks the receiver—because of the bias applied to the suppressor grids of the r-f and i-f stages—but also blocks the AFC circuit. Furthermore, the AFC action is not operative until the desired station is tuned in as indicated by the short circuiting of the primary winding of the AFC transformer and the lighting of the Flash Tuning lamp. For this reason the AFC action cannot take control over the oscillator until the station is tuned in and then of course the AFC circuit keeps the station tuned in exactly. It is clear then that the muting arrangement has a dual function; (1) to provide interstation noise suppression, and (2) to prevent the AFC system from functioning until the desired station is tuned in.

Low-Frequency Discriminator System.

A new AFC system which may be used in the future is shown herewith. The distinguishing feature of this new circuit is that a separate AFC channel is employed in which the normal intermediate frequency of approximately 450 kc is converted to approximately 50 kc before it is applied to the

of usual design practice. When we reach the plate circuit of the last i-f tube, however, we note that the 450-kc i-f signal is coupled through a 25-mmf condenser to the grid of another 6A8 tube. This tube acts as a frequency converter, the first section of the tube being used as an oscillator working at 500 kc or 50 kc higher than the regular i.f. The 500-kc voltage mixes with the 450-kc i-f signal and, as a result, a 50-kc voltage equal to the difference frequency is developed across the primary winding of the discriminator transformer in the plate circuit of the tube.

Not only does this stage function to convert the i.f. from 450 kc to 50 kc, but it also acts to maintain the voltage applied to the discriminator input at a fairly constant level for practically all useful signals. The 2-megohm grid leak returned to ground provides a self-biasing arrangement for strong signals, and further uniformity in the output of the 6A8 converter tube is secured because of the relatively high impedance in the plate circuit. Both of these factors act to provide a substantially constant voltage to the discriminator circuit for all signals exceeding about one volt on the grid of the 6A8 converter-limiter tube.

A variable cathode resistor is used on the control tube to allow adjustment of the cathode voltage by giving an initial bias in the middle of the control characteristic so that a symmetrical oscillator frequency characteristic may be secured for equal positive and negative changes in control voltage. This adjustment varies somewhat for different tubes and in actual practice the 800-ohm resistor would of course be made up of a fixed resistor in series with a small variable second resistor, as previously mentioned in connection with one of the other circuits described in this book.

In the design of the discriminator transformer, the first two tuned circuits are relatively loosely coupled, so that the maximum net bias voltage developed by the discriminator is within the limits of voltage effective in causing variation of the mutual conductance of the control tube. This is done so as to enable the control to release immediately, once the signal channel carrier is shifted to the limit set by the discriminator peak spacing. Where a 6J7 control tube is used, the desired

range of control is secured with a grid voltage variation over the range from zero to minus 10 volts. Thus the maximum net discriminator voltage should be less than 5 volts so that the control tube is never biased beyond cut-off and its grid never goes positive.

In the design of the oscillator control circuit, the 70-ohm resistance in the oscillator tuned circuit provides the r-f grid voltage for the 6J7 control tube. Changing the value of this resistance varies the extent of the oscillator control action. In practice, it is desirable to maintain a substantially uniform oscillator frequency control of about plus or minus 10 kc over the broadcast band; this usually calls for a value of resistance in the tuned circuit of approximately 70 ohms. The effect of excessive resistance in the tuned circuit is to reduce the amplitude of oscillation at the low-frequency end of the band at the same time that the oscillator control action is increased. The condensers in the grid and plate circuits of the control tube are merely blocking condensers to confine the d-c voltages to the desired paths.

It should be pointed out that the proper alignment of the fixed oscillator circuit, which operates at approximately 500 kc, is of extreme importance. Improper alignment of this part of the circuit will seriously impair the performance of the receiver and the highest grade components are used in the tuned circuit of this oscillator in order to insure permanence of adjustment.

CHAPTER VI

ALIGNING AFC CIRCUITS

THE most important consideration in the alignment of receivers equipped with automatic frequency control is that by far the greater part of the alignment procedure is identical with that associated with receivers not so equipped. All the existing rules of good alignment practice are still applicable and should be observed. Expressed in a slightly different manner, AFC alignment is an operation which is supplementary to the regular alignment procedure. However, so important is it that improper adjustment of the AFC circuit trimmers will result in the production of distortion, faulty dial calibration, and generally unsatisfactory performance.

The new principles which are involved in the alignment of AFC circuits are not difficult to understand inasmuch as we have gone over the manner in which these circuits operate in great detail. As a matter of fact the steps which are incorporated in the alignment procedures which follow are a logical consequence of the functions which the various components perform.

As a general rule it can be said that the alignment of AFC circuits, as used at the present time, involves only two adjustments and that of these two only one is really critical. These two are respectively the primary and secondary adjustments of the discriminator transformer, which we shall for convenience denote as C_p and C_s . When these trimmers are adjusted properly, that is, so that the primary and secondary are resonant at the intermediate frequency, then a discriminator characteristic such as shown in Fig. 86 is produced. We

have already discussed the significance of this curve and so it is hardly necessary to go into this again. For the present we are more interested in the effect which the adjustment of the trimmers has upon the shape of this discriminator characteristic. It should be emphasized that it is the shape of this curve and not its polarity with which we are at present concerned, since the relative polarity on both sides of the resonant frequency depends upon the nature of the oscillator control circuit.

Suppose that the primary trimmer is not tuned exactly to the i-f peak. What effect will this have upon the shape of the control voltage characteristic? The most obvious effect of this detuning of the primary circuit of the discriminator is that the control voltage variation will not be symmetrical about the i-f peak; that is, the voltage produced on one side of the i-f peak will be greater than that produced on the other side of the peak. A characteristic of this type is shown

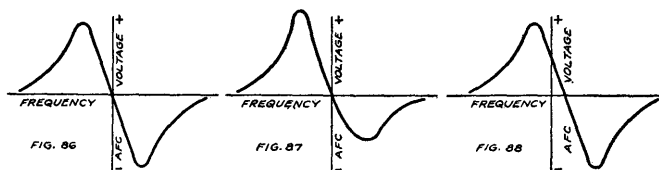

Figs. 86, 87, and 88. In Fig. 86 is shown the discriminator output characteristic when the circuit is correctly aligned. When the primary trimmer is misaligned, the characteristic of Fig. 87 results and when the secondary trimmer is misaligned that of Fig. 88 is produced. Note that misalignment of the primary results in a change of shape in the curve whereas an incorrect adjustment of the secondary trimmer results in zero control voltage being produced at a frequency different from the i-f peak

in Fig. 87. Note that the effect of this uneven control is to increase the range of the AFC action on one side of resonance and to decrease correspondingly the effectiveness of the control for detuning on the other side of resonance. Such a condition is obviously undesirable since it decreases the effectiveness of the AFC circuit in compensating for errors in tuning and oscillator drift.

An inaccurate adjustment of the secondary trimmer of the discriminator is far more serious than a corresponding error in the adjustment of the primary trimmer. Let us see just why this should be so. If you will recall, we showed in the chapter on the discriminator that zero AFC voltage is produced by the discriminator when the applied signal frequency is equal to the resonant frequency of the secondary winding. Note especially that the primary tuning does not enter into this. As a direct result of the dependence of the zero control voltage point upon the resonant frequency of the secondary tuned circuit, any error in this adjustment will shift the entire discriminator characteristic so that zero AFC voltage will occur not at the i-f peak, but at the resonant frequency of the secondary instead. This condition is shown in Fig. 88. It is not difficult to see the effect that this will have upon the operation of the receiver. Instead of the AFC circuit acting to keep the signal so that it will always pass through the i-f amplifier at the i-f peak, the AFC circuit will act to detune the receiver automatically by the amount that the secondary winding is detuned from the i-f peak. This will happen regardless of how accurately the receiver is tuned by the operator. We need hardly repeat here that this condition is undesirable because of the distortion and asymmetrical control which it produces.

Galvanometer Alignment of Primary and Secondary Trimmers.

There are many satisfactory ways in which the discriminator can be aligned and the choice of methods will in general depend upon the type of receiver circuit and the equipment which is available. Indirect as well as direct methods can be used but because the direct methods are simpler to describe and understand, we shall consider them first.

We stated that correct alignment of the discriminator is effected when the discriminator characteristic shown in Fig. 86 is obtained. For this purpose it is convenient then to connect a center scale microammeter or galvanometer, as it is called, across the two cathodes of the discriminator rectifiers. Generally one of these cathodes will be grounded so that one post on the galvanometer can be connected directly to the

chassis. Where one of the cathodes is not grounded, however, it is desirable to make the low potential connection directly to the cathode. The galvanometer must be used in series with a high resistance, of the order of 100M ohms, in order to avoid excessive loading on the tuned circuit. Essentially the galvanometer and series resistance then function as a high resistance center-scale voltmeter.

The signal generator should be connected through a .05-mf condenser to the grid of the tube which works into the discriminator. With the signal generator and galvanometer connected as shown in Fig. 89, the method of procedure is as

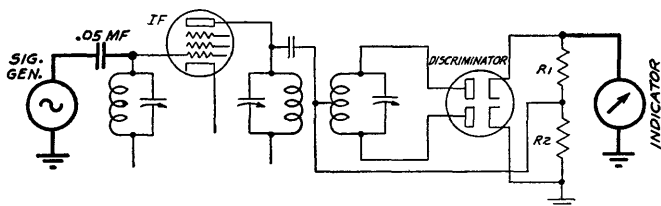

Fig. 89. The signal generator and the output indicator connections used during AFC alignment are shown in heavy lines

follows: Adjust the signal generator frequency to the i-f peak. The AFC switch must be in the "on" position for the adjustments which follow. Increase the output of the signal generator until the galvanometer shows a deflection of about half scale on one side of the zero mark. Then adjust the primary discriminator trimmer so that the deflection of the galvanometer is greatest. If the galvanometer tends to go off scale during this operation, then decrease the output of the signal generator so as to keep the pointer on scale. The adjustment of the primary trimmer is completed when the greatest deflection is obtained. It need not be touched again.

It may happen that it is impossible to obtain a reasonable deflection of the galvanometer needle even though the output of the signal generator is sufficiently great. This is due to the fact that the secondary trimmer is adjusted to exact resonance with the signal so that zero AFC voltage is produced. When this occurs, it is only necessary to change the setting of the

secondary trimmer slightly so as to increase the deflection. The same procedure indicated in the preceding paragraph is then followed to complete the adjustment of the primary trimmer. It is only very seldom that this will happen since with a sensitive galvanometer, only a slight departure from resonance is necessary to secure a reasonable deflection.

The adjustment of the secondary trimmer follows directly upon that of the primary trimmer. With the signal generator and galvanometer connections unchanged, the procedure is to adjust the secondary trimmer for zero deflection. This may not necessarily coincide with the actual zero on the galvanometer scale, but is the reading with no voltage across the galvanometer. The accuracy of the adjustment can be checked by turning the AFC switch off and noting whether there is any deflection of the galvanometer. If there is, then further adjustment of the secondary trimmer should be made until there is no motion of the galvanometer needle when the AFC switch is turned off.

To one who manipulates the secondary AFC trimmer for the first time, this highly critical adjustment will come as a considerable surprise. For this reason we consider it desirable to devote some space to the best method for accomplishing this important adjustment. In the first place, when making this adjustment for zero voltage, there will be, in general, three positions which give zero voltage output. One of these adjustments occurs when the trimmer capacity is at a minimum—the second occurs at maximum capacity, while the third occurs for a position approximately half way between the first two. The minimum and maximum capacity settings of the trimmer are incorrect adjustments and should be avoided. The correct adjustment can always be easily recognized because of the fact that the galvanometer reading changes rapidly from plus to minus for a slight change in the trimmer setting.

When the approximate setting of this trimmer is obtained, the accurate adjustment is made by carefully setting the trimmer so that the galvanometer reading returns to zero. A convenient way to regulate the sensitivity of the adjustment

is by adjusting the output of the signal generator. In this way injury to the galvanometer can be avoided. The procedure is to start with a low value of signal input until the approximate adjustment is made, and then to raise the output of the signal generator so as to make possible the most accurate setting of the secondary trimmer. The final adjustment of the secondary trimmer completes the AFC alignment.

Galvanometer Sensitivity.

A few remarks about the sensitivity of the galvanometer which is required in the above procedure are in order. Instruments having a range of 100 microamperes on either side of the center zero have been found to be entirely satisfactory and to have a sensitivity adequate to insure an accurate adjustment of the secondary trimmer. It goes almost without saying that such galvanometers are not as a general rule part of the equipment of service laboratories. Considering the limited use which a meter of this type has, and considering its relatively high cost, it becomes questionable whether such an investment is worth while. This becomes all the more true when we consider that there are alternative methods available which are capable of producing fully as accurate an adjustment of the AFC circuit.

The Vacuum-Tube Voltmeter Method.

Basically the vacuum-tube voltmeter method employs a procedure which is identical to that just described, with the one exception that the indicator is a vacuum-tube voltmeter rather than a galvanometer. The vacuum-tube voltmeter method has certain advantages over the galvanometer method, outstanding among which is the fact that the vacuum-tube voltmeter is more generally available than the galvanometer. Nor should it be thought for one moment that the vacuum-tube voltmeter method is less sensitive than the galvanometer method, since the reverse is generally true. The vacuum-tube voltmeter method has the further advantage that it draws no current from the discriminator circuit and therefore has no damping effect upon the circuits.

In connecting the vacuum-tube voltmeter across the discriminator load resistors, it is especially important, where an a-c operated instrument is used, that the grounded side of the vacuum-tube voltmeter be connected to the grounded or low side of R2 in Fig. 89. The high side of the vacuum-tube voltmeter is of course connected to the AFC bus. Since a center-scale instrument is desirable, it is convenient to set the zero adjustment of the vacuum-tube voltmeter so that the meter reads approximately in the center of the low voltage range (about 1.5 volts). The latitude of the zero adjustment will generally be sufficiently great to permit this. However, where it is not possible to bring the meter to approximately middle scale, a small flashlight cell, with a high-resistance potentiometer (about 100M ohms) across it can be used to accomplish the same purpose. The connections are shown in Fig. 90. We emphasize that this is necessary only where the

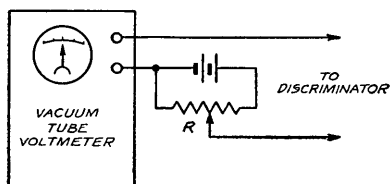

Fig. 90. The potentiometer should be adjusted so that the meter indicates about middle scale with the leads shorted. This is unnecessary if the zero adjustment of the V.T.V.M. can locate the needle at about middle scale on the lowest range

zero adjustment is insufficient to bring the needle near the center of the scale.

With the needle in this approximate position, the adjustment of the primary trimmer is made for maximum deflection (in either direction) while the secondary trimmer is adjusted so that there is no change in the reading when the AFC switch is turned off. The suggestions made in connection with the galvanometer alignment are equally applicable here.

The Control-Tube Current Method.

Outstanding among the methods which make possible an adjustment of the AFC circuit through indirect methods, and without the use of special equipment, is that which we are now going to describe. Essentially this method employs the

oscillator control tube as a vacuum-tube voltmeter and for this reason the procedure is almost identical to that described in connection with the vacuum-tube voltmeter method.

The first step is to open the cathode circuit of the control tube and to insert a 0.5 ma. d-c meter so that it will measure the total cathode current. The normal reading of this meter with the AFC switch off will be in the neighborhood of 2 milliamperes and it will of course change as the AFC switch is turned on, depending upon the value of the control voltage which is supplied by the discriminator. For positive values of control voltage the reading will increase, while for negative values of control voltage, the reading will decrease. The variation of the cathode current with the AFC voltage is shown in Fig. 91.

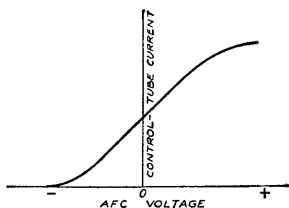

Fig. 91. The cathode current of the oscillator control tube depends on the AFC voltage. This variation is utilized in AFC alignment as explained in the text

In using this method the signal generator is connected to the grid of the tube working into the discriminator transformer. With the AFC switch on, and the frequency of the signal generator set at the i-f peak, the output of the signal generator is advanced until the reading of the cathode current changes. The primary trimmer on the discriminator should next be adjusted so that the maximum deviation from the initial reading is obtained. If too large a value of input signal is used it will not be possible to peak the primary accurately. The remedy is to reduce the input so that the trimmer can be peaked sharply for maximum deflection.

It sometimes happens that the secondary trimmer is so far out of adjustment that no appreciable change in the control tube current occurs as the primary trimmer setting is varied. This can be remedied by making a preliminary adjustment of the secondary trimmer so that it is set at approximately the

middle of its capacity range. This setting can be recognized by the fact that the oscillator plate current will rise and fall very rapidly as the secondary trimmer is varied through this range. With the secondary trimmer adjusted approximately, it will then be possible to go back and adjust the primary trimmer accurately for maximum deflection. The secondary trimmer should not be accurately adjusted before the adjustment of the primary trimmer is made, since this will make it impossible to obtain an appreciable change in the meter reading as the setting of the primary trimmer is varied.

After the primary trimmer is accurately adjusted, the adjustment of the secondary trimmer is made by peaking it so that the cathode current of the control tube returns to the value which it had with the AFC switch in the "off" position. This adjustment is critical and should be carefully made. Turn the AFC switch off and note whether the current changes. If it does, repeat the adjustment of the secondary trimmer until no change is noted when the AFC switch is turned off.

The Two-Signal Method.

An alternative method which can be used to effect a perfect alignment of the AFC system makes use of two signals. The procedure is as follows: Couple one signal generator to the antenna, set its frequency to some point in the broadcast band, and tune the receiver carefully to this signal. The AFC switch should be in the "off" position while these adjustments are made. Now couple another signal generator to the grid of the mixer tube through a small condenser having a capacity of about 20 mmf. It is convenient to clip the signal generator lead to the rubber insulation of the grid clip and the capacity thus formed is generally sufficiently great for the purpose. Set the second signal generator at a frequency equal to the i-f peak, turn the modulation switch off, and advance the output until a beat is heard between the two signals. The receiver tuning should now be changed slightly so as to reduce the frequency of the beat to zero. The setting of the second signal generator should not be disturbed.

Now switch on the AFC and the frequency of the beat note will increase from its zero value as a result. The primary trimmer is now adjusted so that the frequency of the beat note is increased to a maximum. In other words, as the setting of the primary trimmer is varied, the pitch of the beat note will change. The correct adjustment is indicated when the beat note has the maximum pitch. This adjustment should be fairly sharp, and in the event that the pitch of the beat note is too high to permit an accurate adjustment, then the strength of the signal which is fed to the antenna post of the receiver should be reduced. This may fail when a limiter tube is used, in which event one of the alternative methods should be used.

It is important to keep the output of the second signal generator as low as possible. Its output should be sufficiently great so that the beat note is just comfortably audible with the volume control fully advanced. Larger values of output should not be used.

The secondary trimmer should next be adjusted so that the frequency of the beat note, which was previously adjusted for maximum pitch, is returned to zero. In other words, by adjusting C_s to zero beat, that adjustment of the discriminator which gives zero control voltage is obtained. As usual there will be three settings of C_s which produce zero beat and it is especially important that the correct setting be chosen. The settings which occur with C_s set at maximum and minimum capacity are incorrect and should be guarded against. The correct setting occurs for some intermediate value and can easily be recognized because of the rapid change in the beat note which takes place in this region.

The accuracy of the setting can be checked by throwing the AFC switch off and noting whether any change from zero beat takes place. If there is an appreciable change (greater than 100 cycles), then the adjustment should be repeated.

The most obvious objection to this method is that two signal generators are not generally available. However, this difficulty can be overcome by tuning in a local broadcast

station and using this signal to replace the signal generator which is normally connected to the antenna post of the receiver. In the event that the signal strength of this station is too high with the antenna used, it is convenient to insert various values of resistance (the half-watt carbon type) in series with the antenna until the proper signal input is obtained. The input signal should be great enough to overcome the background noise, but preferably no greater. The rest of the procedure is identical with the above and the fact that the broadcast signal is modulated, whereas the signal generator which it replaces is unmodulated, does not cause any difficulty since the beat note can be easily recognized in spite of the modulation.

Alignment of Push-Pull Circuits.

The alignment of push-pull AFC circuits ordinarily presents no special difficulty since the procedure is similar to that used in the case of ordinary AFC circuits. However, in using the control-tube current method, an important modification must be made in the procedure.

You will recall that in this method a milliammeter is inserted in series with the cathode circuit. Since in operation equal and opposite voltages are applied to the twin control tubes, it follows that the total cathode current of the control tube remains essentially constant and independent of the actual AFC voltage which is applied to its grids. To get around this constancy of the cathode current, one of the tubes should be temporarily disconnected from the discriminator, and it will then be possible to correlate the cathode current with the condition of tuning of the discriminator. A convenient way of disconnecting one of the tubes is to remove the lead to the control grid of one of the control tubes, and to connect this grid to ground temporarily while the AFC adjustments are being carried out.

To avoid the necessity for both opening the cathode circuit of the control tube and making the above changes in the grid circuit, we recommend that one of the alternative methods of alignment, which has already been described, be

used in preference to this method. No modification in the alignment procedure is necessary when using any of the other methods on push-pull circuits, and they are generally more convenient to use than the control-tube current method. Note that the reference which is made to the output of the discriminator in the preceding sections of this chapter should be understood to mean, in the case of push-pull circuits, either side of the center-tapped discriminator output.

The Visual Alignment Method.

We are including a description of the method of using the cathode-ray oscillograph and the frequency-modulated signal generator to align the AFC circuit primarily because of a desire on our part to make this book as complete as possible.

Where you desire to use visual equipment for AFC alignment, because this equipment was used in connection with the alignment of the i-f amplifier—and is therefore completely set up—then the procedure is as follows: *Connect the frequency-modulated signal generator to the grid of the i-f tube and leave the frequency setting at the same value as that which was used in aligning the i-f amplifier. This is extremely important and should be carefully observed.* Connect the vertical deflection post on the oscillograph to the ungrounded cathode of the discriminator diode. The large condenser which bypasses this point to ground must be temporarily disconnected. However, the small by-pass condenser (about 200 mmf) which is sometimes connected close to the cathode is essential and should not be removed. If such a condenser is not used in the particular receiver being aligned, one should be temporarily connected during the alignment procedure. The synchronizing connections between the sweep and the frequency-modulated signal generator will vary, depending upon the type of equipment which is used. These connections, of course, remain exactly the same as for the alignment of the i-f amplifier.

It is assumed in using the visual method that the primary discriminator trimmer has already been adjusted in connection with the i-f amplifier alignment. The adjustment can be made more accurately by making use of its effect upon either

the audio output or upon the AVC action. Where a separate channel is provided for the AFC system, the above will not be true. In this case the primary discriminator trimmer should be adjusted at the same time that this channel is aligned. At any rate it is not recommended that the primary trimmer be adjusted by noting its effect upon the S-shaped discriminator characteristic which appears on the screen of the cathode-ray tube.

The signal generator should be connected to the grid of the first i-f tube through the usual blocking condenser of about .05 mf. Assuming that the AFC alignment is perfect, and that the double image type of equipment is being used, then the curve shown in Fig. 92 will appear upon the screen of the oscillograph. Note that this pattern consists of the familiar discriminator characteristic, shown in Fig. 86; because of the fact that the image is traced out by both a forward and reverse frequency sweep, both an erect and an inverted trace of this characteristic appear.

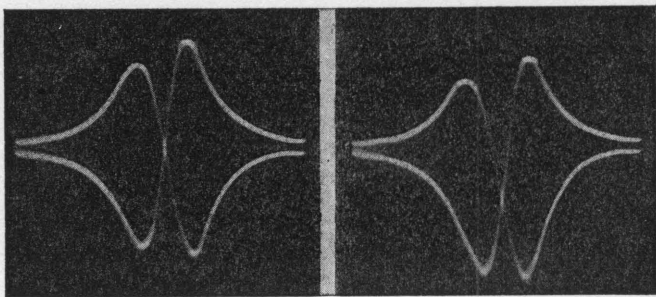

Figs. 92 and 93. The oscillogram of Fig. 92, left, is the type of pattern obtained when the discriminator trimmers are correctly adjusted. The effect of an incorrect adjustment of the secondary trimmer is shown in Fig. 93

Correct adjustment of the secondary trimmer is indicated, as Fig. 92 shows, when the two traces intersect symmetrically so that their intersection lies on the zero axis. The significance of this is that the zero control voltage is produced at the i-f peak which is equal to the periodic frequency.

The effect of an incorrect setting of the secondary trimmer is indicated in Fig. 93. As we explained at the opening of this chapter, incorrect tuning of Cs shifts the response of the discriminator so that zero AFC voltage is produced not at the i-f peak but instead at the frequency to which the secondary happens to be tuned. The change from the correct condition shown in Fig. 93 is due to only a slight change in the setting of the secondary trimmer from resonance. Since a relatively small displacement of the two curves means an appreciable error in the tuning of the secondary circuit, too much care cannot be exercised. The by-pass condenser which was temporarily disconnected should be replaced when the adjustment is completed.

A word of caution as to the type of trace which can be expected for different receivers and under different conditions is in order. The type of pattern will be found to vary widely, because the amount of selectivity which precedes the discriminator has an important bearing on the exact shape of the trace appearing on the screen of the cathode-ray tube. Where the selectivity of the circuit is high, the outer sections of the trace will tend to be close to the zero axis line; while if the selectivity of the preceding circuits is comparatively small, the outer portions of the trace will be offset considerably from the zero axis. In every case where an i-f transformer precedes the discriminator, this transformer must be accurately peaked to avoid destroying the symmetry of the trace. Regardless of the exact shape of the curve, the method of making the adjustment of the secondary trimmer follows along the lines indicated in the previous paragraph.

It is not our intention to devote space in this book to a discussion of the method of operation of visual alignment systems. If you are not familiar with this subject, a complete description of the various systems of visual alignment, using the cathode-ray oscillograph and the frequency-modulated signal generator, will be found in "The Cathode-Ray Tube at Work" by Rider.

Alignment of Iron Core Discriminators.

Throughout this chapter on alignment we have referred to the adjustment of the primary and secondary trimmers as the means for securing the proper alignment of the discriminator circuit. As we had occasion to discuss in the chapter dealing with commercial receiver circuits, there are a number of receivers which use fixed condensers in the discriminator circuits. For these receivers, the tuning of the primary and secondary circuits of the discriminator is accomplished by adjustment of the inductances in the tuned circuits, rather than the capacities across these inductances. In accordance with conventional practice, the variation of the inductance associated with each of the windings is accomplished by moving its iron core.

No change in the alignment procedure is of course necessary for these receivers using iron core discriminator transformers, but you should bear in mind that wherever the instructions in this chapter call for the adjustment of the primary trimmer, it is the core associated with the primary winding which must be adjusted. In like manner, wherever the instructions call for the adjustment of the secondary trimmer, it is the secondary inductance which must be adjusted. As a further illustration of the equivalence of inductance variation with that of trimmer variation, you should understand that the effect of misalignment of the primary and secondary trimmers, as described previously (see Figs. 86-88), is equivalent to that which would be caused by a misalignment of the primary and secondary inductances of the discriminator transformer.

Radio-Frequency and Oscillator Alignment.

As we pointed out in an early part of this chapter, the alignment of the AFC circuit is a relatively small, but nevertheless important, part of the complete alignment procedure. After the alignment of the i-f amplifier and the discriminator has been completed, the oscillator and the radio-frequency sections should be aligned in accordance with conventional practice.

By this we mean that the procedure from this point on is exactly the same as though the receiver were not equipped with AFC. In this connection it is of the utmost importance that the AFC switch be in the "off" position for these adjustments, in order to prevent the AFC action from compensating for errors in the alignment of the oscillator circuit. Since the procedure does not differ from that ordinarily required for oscillator and r-f alignment, we are not including details on the manner in which this is accomplished. This subject is completely covered elsewhere, as, for example, in "An Hour a Day with Rider on Resonance and Alignment" by this author.

Alignment of Commercial Receiver Circuits.

We have discussed in general terms the methods which make possible the alignment of AFC circuits. The principles which have been explained in this chapter are general principles which are applicable to all receivers and should be understood because of their basic and fundamental nature. However, before leaving this subject of alignment, we should like to consider some of the circuits which are being used in commercial receivers and to show how the general principles of AFC alignment are applied to specific receivers. For more complete alignment of specific receivers equipped with AFC, we refer you to "Rider's Manuals" Volumes VII and VIII.

Philco 37-9, 37-10, 37-11.

That part of the AFC circuit of these receivers which is of interest from an alignment viewpoint is shown in Fig. 94. Note that the discriminator transformer is a three-winding transformer, containing a primary winding which is coupled to the second detector winding and to the center-tapped AFC winding. These circuits are tuned respectively by the trimmers C1, C2 and C3.

Now the question arises as to the most convenient method for effecting the AFC alignment of this receiver. An inspection of the circuit will show you that C1 and C2 can be aligned in the conventional way using an ordinary output

meter connected to the voice coil or to the output tube, since these two windings function to feed the i-f signal to the second detector. In other words C1 and C2 are peaked for maximum output, exactly in the same manner as if the set were not equipped with AFC and just as though there were no additional center-tapped winding on the last i-f transformer. In making these two adjustments, the output of the signal generator must be kept at a low value so as to prevent the AVC action from making it impossible to peak the trimmers sharply.

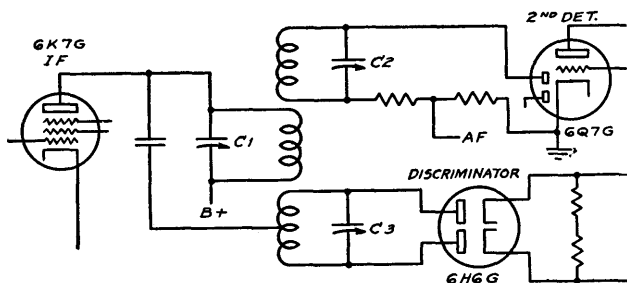

Fig. 94. Trimmers C1 and C3 are the AFC adjustments in the Philco Model 37-9 receiver

The adjustment of C3, the secondary trimmer of the discriminator transformer, can be made in any one of a number of ways. *If the control-tube current method is used, it is highly important that the AFC lead feeding the grid of one of the triode sections of the control tube be removed temporarily and that grid grounded while C3 is being adjusted.*

Any of the other methods described previously for the adjustment of the secondary trimmer can also be used for the alignment of C3.

Philco 37-116, 37-675, 37-690.

The discriminator circuit used in these receivers is shown in Fig. 95. The chief point of interest in this circuit from an alignment viewpoint is that the i-f signal voltage which is fed to the AVC diode is obtained from the i-f voltage

developed across the primary winding of the AFC discriminator transformer. This furnishes a convenient method for the alignment of the primary discriminator trimmer C_p .

The procedure is to align the receiver completely in the usual manner, with the AFC switch in the "off" position. Then feed a strong signal into the first detector at the i-f peak and adjust C_p for *minimum* output. It is important

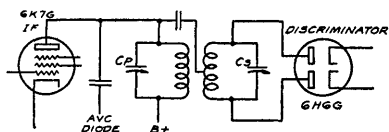

Fig. 95. C_p and C_s are the AFC adjustments required in the Philco Model 37-116 receiver

that a strong signal be used so as to insure that the AVC system will function. It will be necessary to retard the volume control to prevent the audio amplifier from being overloaded.

The adjustment of the secondary trimmer C_s follows along conventional lines, any one of the previous procedures being applicable. Since this receiver uses a push-pull control circuit, the usual steps must be taken if the control-tube current method is chosen—the AFC lead to the grid of one of the tubes must be disconnected and the grid of that section grounded temporarily.

Crosley Model 1316.

The AFC circuit of this receiver is shown in Fig. 68. Since the AVC voltage is obtained from the discriminator circuit, it follows that the alignment of the primary trimmer can be most easily carried out in the manner just described for the previous receiver.

If the control-tube current method is used to align the secondary trimmer, the manufacturer recommends that a 0-5 ma. meter be inserted in series with the cathode of the 6J7. The bias voltage on this tube should previously be adjusted to 4.8 volts with the AFC switch in the off position.

To check the performance of the AFC circuit, it is recommended that a local station in the neighborhood of 1400 kc be tuned in with the AFC switch off. There should be no change in the character of the signal when the AFC switch is turned on, and furthermore it should be possible to detune the receiver about 15 kc on either side of the station frequency without any appreciable change in the signal.

Sears-Roebuck Receivers.

The discriminator circuit used in these receivers was shown in Fig. 54. We suggest that you refer back to the figure which is shown there in connection with the alignment procedure which we shall now describe.

Inasmuch as this discriminator supplies the audio voltage, a convenient way to align the trimmers C1 and C2 is to feed a signal at the i-f peak into the grid of the i-f tube and to adjust C1 and C2 for maximum output, as indicated by an output meter connected across the voice coil or the plate of the output tube. A signal just strong enough to give a reasonable reading should be used so as to prevent the AVC action from occurring.

The alignment of the secondary trimmer can be made by any one of the conventional methods previously described.

The manufacturer suggests that the performance of the receiver be checked in the following manner: Connect the output of a signal generator, which is adjusted to give a modulated signal at 1000 kc, to the antenna of the receiver through a .00025-mf. condenser. Adjust the output of the signal generator to 5000 microvolts, and connect an output meter across the speaker voice coil. With the AFC switch off, tune the receiver sharply for maximum output. Then reduce the volume control setting until the output meter reads 1.5 volts. Now turn on the AFC.

With this setup, the frequency of the signal generator should be decreased until the reading of the output meter drops to .5 volt and the frequency setting corresponding to this condition noted. Similarly the frequency of the signal generator should be advanced above 1000 kc until the output

again drops to .5 volt, and the frequency at which this occurs noted.

If the AFC is operating properly, then the signal generator frequency can be shifted about 15 kc on either side of 1000 kc before the output drops from 1.5 volts to .5 volt.

While the above illustrates the performance of the Sears-Roebuck model 4587 receiver, it can be taken roughly as a guide of what can be expected from other receivers employing similar AFC circuits.

Westinghouse WR-315.

At first glance it might seem that the alignment of this receiver would be difficult because of the double superheterodyne principle which is used. However, this is not so since the alignment of the AFC circuit is no different in this receiver from that in a simple superheterodyne. Referring to Fig. 70, the alignment is effected by feeding a 100-kc signal into the grid of the limiter tube and adjusting the primary trimmer C_p for the greatest AFC voltage. This can be measured either with a galvanometer across the AFC bus, by means of a vacuum-tube voltmeter, or by means of the control-tube current method. Regardless of the method which is employed, the primary trimmer should be adjusted for maximum deflection of the indicator in either the positive or negative direction.

After C_p is adjusted, C_s is aligned by adjusting it so that the AFC voltage drops to zero. It is suggested that you read the section in the first part of this chapter which pertains to the type of indicator which is being used.

All the remaining alignment adjustments in this receiver should of course be made with the AFC switch in the "off" position.

Determination of Primary and Secondary Discriminator Trimmers.

It will sometimes happen that the service data available for a given receiver do not contain information which makes it possible to distinguish the primary trimmer of the discrimina-

tor transformer from the secondary trimmer. In these cases the following simple check makes it possible to determine which is the secondary trimmer and which is the primary trimmer, so that the alignment procedure can be properly carried out.

Tune in a signal with the AFC switch in the "on" position and touch a metal screwdriver to each of the trimmers in turn. In the case of the secondary trimmer there will be a marked change in the output of the receiver, while there will be only a relatively small effect in the case of the primary trimmer. Of course, the metal screwdriver should be used only for this check, and the final adjustment should be made with a non-metallic screwdriver.

In the case of trimmers with insulated adjusting screws or transformers with movable iron cores, the above method will not work. In these cases the two adjustments must be distinguished from each other by noting the effect which they have upon the indicator being used. This in general is not difficult since the effect of the secondary adjustment is considerably greater than that of the primary.

Alignment Precautions.

By way of summary we have tabulated below a number of precautions which should be observed in connection with the alignment of AFC circuits.

1. The receiver should be turned on 15 minutes before it is aligned, to allow it to reach its normal operating temperature.
2. The alignment of the r-f, oscillator, and i-f amplifiers must be made in the conventional way with the AFC switch in the "off" position.
3. The same frequency setting of the signal generator which is used to align the i-f amplifier, must be used to align the discriminator.
4. There are generally three adjustments of the secondary discriminator trimmer which will give the proper indication. These occur with the trimmer set at maximum

capacity, at minimum capacity, and at some intermediate position. The last adjustment is the correct one and can be easily recognized because of the critical control which it has over the AFC voltage.

5. The oscillator control tube should not be changed once the alignment has been completed, as a tube having a different mutual conductance will change the dial calibration. Some sets provide a cathode bias adjustment to compensate for such variations.
6. Inadequate AFC action and failure of the dial to track may be due to low mutual conductance of the oscillator control tube—try another tube.
7. It is desirable that all alignment operations, including those with the AFC switch in the "off" position, be made with the line voltage set at a value which corresponds to the average line voltage experienced at the customer's home. Failure to observe this precaution may result in poor dial calibration and asymmetrical control. This is especially important in the case of control circuits which use a fixed value of bias voltage on the control tube, rather than a self-biasing arrangement.

Setting up AFC Stations.

Many AFC equipped receivers are provided with automatic dialing arrangements, one of which is shown in Fig. 96. The

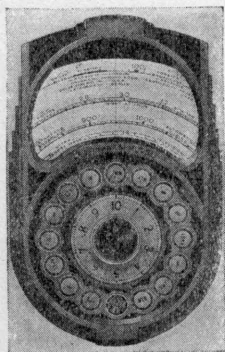

Fig. 96. A typical dial used with an AFC equipped receiver. Similar dialing arrangements, which differ in certain mechanical features, are used in many AFC receivers

Courtesy of Fairbanks, Morse & Co.

purpose of this type of tuning arrangement, which resembles a telephone dial, is to simplify tuning by substituting rapid dialing of the station for the otherwise comparatively careful setting of the tuning control which is necessary in receivers not equipped with AFC. It goes almost without saying, that all receivers which have AFC circuits do not have a dialing arrangement, although the tendency in the newer receivers is toward the use of an automatic dialing or push-button arrangement.

As is evident from Fig. 96 only a limited number of stations can be tuned in through the use of the dial arrangement. It follows, then, that a choice must be made as to which stations will be selected so that they can be tuned in through the use of the dial. In general this choice falls upon the serviceman installing the receiver, who should keep certain important considerations in mind.

It is a general characteristic of AFC systems, as we had occasion to point out elsewhere in this book, that the AFC action is generally more effective in correcting a given error in tuning in the case of a strong station than in the case of a weak station. In fact, on very weak signals, the AFC action cannot be relied upon to correct for errors in tuning to any great extent and there is always considerable chance of a stronger signal on an adjacent channel taking control of the oscillator and preventing the reception of the weaker signal which happens to be the one that is desired. To avoid this effect, the stations which are picked out for automatic dialing should all be strong, preferably local, stations which give good daylight reception. Weaker stations which do not give consistently good reception and with signal levels not well above the noise level should be avoided as choices for automatic dialing. These weaker stations can of course be tuned in the conventional way, with the AFC on in most cases (see exceptions to this later), by using the regular tuning knob which is provided in conjunction with the automatic dialing arrangement.

As a general rule, the number of stops provided is sufficient so that none of the local stations to which the customer frequently listens will have to be omitted from the automatic dialing provision. The exact procedure which is to be used in setting up stations varies considerably for the different

makes of receivers, and it is beyond the scope of this book to supply complete information as to the mechanical steps required in setting up these stations. This material is supplied in the Rider Manuals which contain the manufacturers' detailed instructions. We strongly suggest that these instructions be referred to when working on a particular model for the first time.

Apart from certain mechanical and electrical features which are different for different makes of receivers, there are a number of points which are generally applicable regardless of the make of receiver which is being set up for AFC dialing.

Before going ahead with the setting up of the stations it is desirable to check the calibration of the receiver over several points on the broadcast band, preferably by noting the points at which the several strong local stations come in. The AFC switch should be in the off position for this operation and the dial should check with the known station frequencies to within five kc—at least in the more expensive receivers. In lower priced receivers a 10-kc variation is permissible. If the calibration of the receiver is poor, then the alignment should be rechecked.

Setting up Stations 10 kc Apart.

Ordinarily it is not advisable to set up stations for automatic dialing which are separated by less than 20 kc since there is a tendency for the automatic control to jump from one station to another depending upon the relative strength of the two stations and the position in which the tuning condenser is left after the automatic dialing. However, in some localities it may happen that there are two fairly strong stations which the customer wishes to have set up and which are separated by only 10 kc. In cases of this sort a special procedure is required.

Where the two stations are of approximately the same strength, it is advisable to stagger the stations by a few kc from the position called for by the frequency of the stations. For example, suppose that the two station frequencies are 810 kc and 820 kc. As Fig. 97 shows, the tuning dial should

130 AUTOMATIC FREQUENCY CONTROL SYSTEMS

be adjusted so that the 810 kc station is tuned in at 807 kc, while the 820 kc station is tuned in with the dial reading at approximately 823 kc. In this way the dial separation between the two stations is increased from 10 kc to 16 kc and the likelihood of the control slipping from one station to the other is correspondingly reduced.

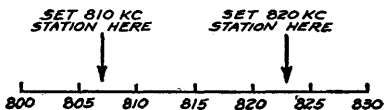
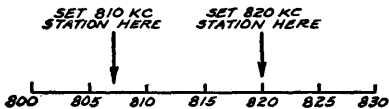

Fig. 97. When setting up two equally strong stations which are only 10 kc apart, they should be staggered as indicated on the left

Fig. 98. When setting up a weak and a strong station, the weaker (820 kc) should be set exactly and the stronger should be staggered two or three kilocycles



It should be observed that there is no distortion introduced as a result of the mistuning since the AFC action is capable of correcting for the mistuning of 3 kc in each station. This mistuning of course takes place only when the station is tuned automatically and does not occur when the AFC switch is off and the station is tuned in in the conventional way.

Where the two stations which are to be set up are not of the same strength, it is advisable to use a slightly different procedure. If we suppose that the 810 kc station, to use the same illustration, is considerably stronger than the 820 kc station, then it is advisable to offset the adjustment of the stronger station, but to set up the weaker station in the usual manner. As Fig. 98 shows, the 810 kc station should be staggered 3 kc and therefore set up at 807 kc, while the 820 kc station would be set up at exactly 820 kc.

Again this procedure has as its aim the maximum separation between the two stations. But, in this case, where one station is considerably stronger than the other, it is desirable to offset only the stronger station because the AFC action is more effective on the stronger station than it is on the weaker

station. If the weaker station were offset, there would be more of a tendency for the AFC to lose control of the weaker station and possibly, as the receiver adjustments aged, reception of the weaker station might become distorted.

Performance of Circuit.

In connection with the setting up of stations, it may be of interest to cite a few facts concerning the performance of AFC circuits. The facts which follow are associated with one particular receiver, but you will find that they are in great measure applicable to the majority of receivers.

Assuming that a receiver is mistuned by say 3 kc, the AFC action will bring the receiver into tune so that the i-f signal deviates by less than 50 cycles from the i-f peak. This is for an input signal of the order of 1000 microvolts. For weaker signals the degree of control is correspondingly smaller and similarly for stronger signals the deviation from the correct value is even less than 50 cycles. For example, at 100 microvolts input, the number of cycles off resonance is approximately 400 cycles, while above 1000 microvolts the degree of mistuning is approximately constant at 40 cycles.

For greater amounts of mistuning, the deviation of the i-f signal carrier from the correct value is proportional to the degree of mistuning. Thus, for 6 kc away from resonance, the deviation of the carrier is 80 cycles whereas it was 40 cycles for a mistuning of 3 kc. Similarly, for a mistuning of 9 kc the tuning is corrected to within approximately 120 cycles.

As we mentioned in the opening chapter of this book, it should be kept in mind that AFC overcomes the undesirable effects of inaccurate tuning only insofar as the i-f amplifier is concerned. The r-f and detector tuned circuits are not automatically corrected and for this reason it is important that errors in manual tuning be kept to a minimum. Therefore, when the error in tuning is as high as 8 or 10 kc, then even though the AFC action is effective in correcting the oscillator frequency, the asymmetry and mistuning of the r-f circuits may be sufficiently great so that serious distortion is introduced.

CHAPTER VII

SERVICING AFC SYSTEMS

THE servicing of receivers equipped with AFC presents certain new problems which can be best met by considering them—insofar as possible—apart from the rest of the receiver. It has been found advantageous in tracking down trouble in AFC circuits to look upon the receiver as being composed of two distinct and, for the most part, separate units—the one unit being the complete receiver exclusive of the AFC circuit, and the second unit being the AFC circuit. With this convenient separation, it should be made a general practice to see that the receiver is functioning properly with the AFC switch in the “off” position before any attempt is made to correct an apparent fault in the AFC circuit proper. Since an AFC-equipped receiver with the AFC switch in the “off” position corresponds almost exactly to a conventional receiver, the methods for analyzing this section of the receiver will not receive any attention in this book. It will be taken for granted that you are familiar with the best practice for accomplishing this.

Unfortunately, however, it is not possible to make an absolutely clear cut and definite division for service purposes as to whether a certain fault or symptom is due to a defect in the AFC circuit or whether it is due to a defect in some other part of the receiver circuit. To a certain extent, whether or not this is possible will depend upon the nature of the fault or the symptom, and as a general rule it is quite easy, from the nature of the circuit employed, to determine whether the fault is due to the AFC circuit or whether it lies in another part of the receiver.

For example, suppose that a receiver equipped with an AFC circuit which is operative only on the broadcast band shows an abnormally high hum in the output *on all bands*, and that this hum is present whether the AFC switch is "on" or "off." How can we be certain whether the hum is being introduced through the AFC circuit or through some other part of the receiver? In this case it can at once be definitely stated that the trouble is not arising in the AFC circuit because if it were, the hum would not, in general, be present on the short-wave bands. This immediately eliminates the necessity for trouble shooting in the AFC circuit.

On the other hand, if the hum were present on just the broadcast band alone, then it would require a further investigation to establish definitely whether the trouble is in the AFC circuit. Such an investigation would proceed along the following lines: The hum is present on the broadcast band and not on the shortwave bands; it is present whether the AFC switch is "on" or "off"; therefore if the hum is being introduced in the AFC circuit, then it must be introduced through the oscillator control stage *since the discriminator is removed from the circuit when the AFC switch is in the off position*. A convenient way to eliminate the control tube as a suspect would be to remove the control tube temporarily and retune the receiver for maximum output. If the hum disappears, then the hum is being introduced through the control stage; if the hum remains, then the AFC circuit is definitely eliminated as a possible source of the hum.

In the simple case where the receiver shows a hum in the output only when the AFC switch is in the on position, then it follows at once that there is some defect in the AFC circuit. An investigation should then follow to determine the point of origin of the hum voltage.

We mention the above examples not alone for their intrinsic interest but to show that trouble shooting can be simplified appreciably if you will take the time to analyze the symptoms in the light of the manner in which the various circuits operate.

Checking the Discriminator.

In the event that a preliminary examination shows that the AFC system is not functioning properly, one of the first steps should be to examine the discriminator circuit. There are two ways of making this check: one method is to check every part and operating condition in the discriminator, and the other is to examine the output of the discriminator when a signal at the i-f peak is applied to the grid of the tube working into the discriminator—generally the i-f tube. The latter method is to be preferred, since it establishes in a minimum amount of time whether the trouble is in the discriminator circuit. If the latter is operating properly, then the voltage across the AFC bus (as indicated by a vacuum-tube voltmeter or galvanometer) will vary as shown in Fig. 26, when the input frequency is varied about 15 kc on either side of the i-f peak. In this same connection the remarks which were made concerning the improper alignment of the discriminator trimmers on the type of characteristic which is produced should be noted. It may sometimes happen that failure of the AFC circuit to function properly is due only to improper adjustment of the discriminator trimmers. Should this prove to be the case, the trimmers can be adjusted while the vacuum-tube voltmeter and the signal generator are connected for the discriminator test.

If the overall check of the discriminator shows that it is not operating properly, then a continuity check of the circuit should be made. As a general rule this, in conjunction with a test of the various components involved in the discriminator, will show up the trouble. Where a vacuum-tube voltmeter is available, it will be found helpful in checking the operation of the discriminator transformer.

Checking the Control-Tube Circuit.

Where the overall check of the discriminator shows that it is operating properly, then this check should be followed by an inspection of the control-tube circuit. For this purpose, it is convenient to connect a milliammeter in the cathode circuit of the oscillator control tube (a 0-5 ma. meter is satis-

factory) and to connect the signal generator to the grid of the i-f tube or the tube working into the discriminator. As the frequency of the signal generator is varied on both sides of the i-f peak, the plate current of the control tube should follow the variation shown in Fig. 91.

Where the plate current of the oscillator control tube does not show the correct variation, a continuity and voltage check of the stage should be made to find the cause of the trouble. It goes almost without saying that the first check which should be made is to replace the control tube with another tube known to be in good condition. As always, the course of the procedure will be guided by an inspection of the schematic and the symptoms which the receiver shows as the tests proceed.

Improper Operation of Oscillator.

It should be understood that there is a definite relationship between the oscillator control tube and the oscillator, which is maintained on all bands where the AFC circuit functions—and which holds regardless of whether the AFC switch is on or off. For this reason failure of the oscillator to function properly, and in some cases complete stoppage of oscillation, can be traced sometimes to abnormal conditions in the control tube circuit. Under normal operating conditions, the control tube circuit not only reflects a certain amount of inductance across the oscillator tuned circuit, but it also reflects a resistive component which tends to damp the oscillator. This tends to make the oscillator tube more critical than it ordinarily would be in circuits not employing AFC, since a higher value of mutual conductance is required in the oscillator tube in order to maintain oscillation. Therefore, it is possible that an oscillator tube which might be satisfactory in a receiver not equipped with AFC will fail to oscillate in a receiver which is equipped with AFC.

Where replacement of the oscillator and oscillator control tube fails to restore normal operation of the oscillator circuit, the control tube should be removed from the socket. If the oscillator functions after the control tube is removed from the socket, then the control tube circuit should be ex-

amined to determine the defective condition. The usual causes of such a condition are abnormally high values of screen and plate voltage and insufficient bias on the control tube.

Hum.

The arrangement of the circuit in an AFC-equipped receiver is such that even small fluctuations in the voltages supplying the oscillator control tube will affect the output to an appreciable extent. Insofar as this influences the alignment of the receiver, we have previously seen that it is advisable to carry out alignment operations with the line voltage set at a value corresponding to the voltage encountered where the receiver is to be used. Apart from this consideration, the fact that a variation in the plate, screen, or bias voltage of the control tube makes itself effective as a change in the frequency of the oscillator, results in the necessity for careful and unusually complete filtering of the voltage supply for the control tube.

An abnormal amount of hum in the output of an AFC-equipped receiver which is present only on the bands where the AFC system is operative should at once call for an inspection of the AFC circuit. Common causes of such a hum effect are an open filter condenser, decrease in the capacity of one or more of the electrolytic filter condensers, or cathode-heater leakage. The mechanism by means of which this hum is produced is as follows: The hum voltage present on one or more electrodes of the oscillator control tube varies the frequency of the oscillator at the hum frequency and consequently this is reflected as a periodic change in the frequency of the signal passing through the i-f amplifier; as a result of the selectivity of the i-f amplifier, this finally reaches the output in the form of a hum voltage which is reproduced by the speaker.

In some cases the hum may have its source in the discriminator rather than in the voltage circuit. A common cause for this trouble is leakage between the heater and the ungrounded cathode of the 6H6 discriminator tube. As a general rule, the large filter condenser which bypasses this point to ground (see C1 in Fig. 45) is effective in preventing any hum voltage

from being introduced into the AFC control voltage from this source. However, if this condenser should open up, the result will be the introduction of considerable hum into the AFC control voltage supply. The resulting hum would of course be present only when the AFC switch is on.

Time Constant.

The relative time delays or time constants of the AFC and the AVC circuits have an important effect upon the overall operation of the receiver. Before we consider this question, however, let us explain briefly what is meant by the time constant of a circuit. In general, a time constant is a measure of the delay taking place before a voltage which is impressed or changed at one point in the circuit becomes effective at another point. In the case of an AFC circuit, the time constant is a measure of the amount of time it takes for a change in the voltage developed at the discriminator to reach the grid of the oscillator control tube. In the case of an AVC circuit, the time constant is similarly a measure of the amount of time required for a change in the voltage output of the AVC rectifier to reach the grids of the controlled tubes. In both these cases, and in general, it can be stated that the greater the amount of series resistance and shunt capacity in the network, the greater is the time constant of the circuit. This is explained in detail in "An Hour A Day with Rider on AVC."

It is general practice to design AFC-equipped receivers so that the time constant of the AFC circuit is greater than that of the AVC circuit. If, however, one of the condensers in the AFC feed line opens up for some reason or other, the time constant of the AFC circuit is decreased below its normal value. As a result, when tuning from a weak signal to a strong signal, the AFC circuit rapidly corrects the frequency of the oscillator so as to bring a signal into the center of the i-f amplifier band-pass before the AVC circuit has had a chance to cut down the gain of the receiver from its previous high value corresponding to a weak or zero signal input. Since the receiver is still in a highly sensitive condition, there

is a momentary blast of volume before a steady operating condition is reached. (Some of the newer AFC sets use a relatively narrow control and rely on the "momentary blast" to make the presence of AFC noticeable to the customer. In these cases, the AFC time constant is purposely made somewhat less than that of the AVC circuit.)

Under normal conditions, where the AFC time constant is greater than the AVC time constant, this action which has just been described is avoided. This follows because the AVC system is effective in cutting down the gain before the AFC circuit changes the oscillator frequency so as to correct the tuning. In practice, the AFC time constant is not made too large since this would make it impossible for the system to correct for rapid fluctuations in the oscillator frequency such as might be brought about by fluctuations in the line voltage.

Secondary Trimmer.

The importance of the secondary trimmer in determining the operation of the AFC circuit has already been mentioned. In some few cases the secondary trimmer of the discriminator transformer may require frequent adjustment. As a general rule the adjustment of this trimmer should be checked whenever throwing the AFC switch "on" introduces hiss and distortion into the output.

There are a number of different arrangements used to attain stability and permanence of adjustment of this trimmer. In some receivers a fixed air condenser is used in parallel with a variable air trimmer. In other receivers a small compression type mica condenser is used in parallel with a fixed mica condenser, the latter of which is specially treated so as to show a minimum fluctuation with respect to aging, temperature, and humidity changes. In still other receivers, a single trimmer is used which is similar to the trimmers used in the other i-f transformers. In general, the latter type of trimmer is more likely to call for frequent readjustment, and in cases where the discriminator constantly requires readjustment, the entire transformer should be replaced with an improved assembly.

Loss of Signal Control.

One of the complaints which is frequently made by laymen using AFC-equipped receivers is that a receiver will often be reproducing a program with perfect fidelity when for no apparent reason the signal disappears and is succeeded by interstation noise. To understand why this happens, it is necessary to consider the action taking place as the receiver is tuned from a point where no signal is present to a signal channel. Assuming that the frequency of the signal to which the receiver is being tuned is 1000 kc, let us trace the variation in the output, as the carrier is approached from the low frequency side. As Fig. 99 shows, the AFC circuit takes con-

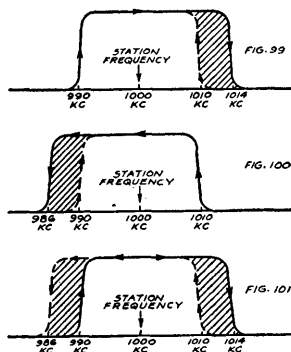

Figs. 99, 100, and 101. When a 1000-kc station is tuned in from either the low-frequency side (Fig. 99) or the high-frequency side (Fig. 100) the AFC circuit takes control 10 kc below or above 1000 kc and maintains control until approximately 14 kc on the other side of the carrier frequency. The shaded area indicates the region of unstable control. Fig. 101 is a combination of Figs. 99 and 100. Arrows indicate the direction in which the set is tuned

trol at 990 kc and keeps the output substantially flat until 1014 kc at which point the AFC circuit loses control and the output drops rapidly to zero. Now the following peculiar effect takes place as the receiver is tuned back from 1014 kc towards 1000 kc: the AFC circuit does not take control so as to restore the signal *until 1010 kc is reached*.

The significance of this is that whenever a receiver is tuned within the shaded area, it is in an unstable condition. Thus, if the signal intensity should decrease slightly, perhaps because of fading, the signal would be lost, and furthermore, it would not return after the fading. In some cases, a sudden drop in

line voltage may cut down the AFC action sufficiently so that the station is completely lost and does not return when the line voltage rises again.

If the receiver is not equipped with a noise suppression circuit, this loss of signal control is followed directly by an objectionable amount of noise, the intensity of which depends upon the sensitivity of the receiver and the noisiness of the location.

To avoid this type of complaint, the set operator should be instructed to tune in the desired station with a reasonable amount of care so as to avoid setting the tuning control so that the receiver is operating on the outer edge of the control band—that is, within the shaded areas in the figures.

Careless tuning is especially detrimental and productive of this effect on the short-wave bands where fluctuations in the oscillator frequency and fading are much more common. If a reasonable amount of care is exercised in the initial setting of the tuning control, the AFC system will be better able to compensate for the usual fluctuations in the oscillator frequency. However, if the tuning is very far off to begin with, it will often happen that a slight additional change will cause the AFC circuit to lose control as explained above.

For simplicity, only one half of this action was shown in connection with Fig. 99. Actually, however, the same effect occurs when the receiver is detuned below resonance, as is shown in Fig. 100. Here again, the AFC action keeps control until the receiver is detuned 14 kc below resonance; but once control is lost, the receiver must be retuned to at least within 10 kc of the carrier (990 kc) until control is regained. The resultant action which is a combination of Figs. 99 and 100 is shown in Fig. 101. Here again, the shaded areas indicate the regions where the AFC control is unstable.

Motorboating.

In addition to its other effects, (hum, change in calibration, etc.) the susceptibility of the oscillator control tube to changes in electrode voltages is sometimes the cause of motorboating. As a general rule, this will sometimes occur when

a strong signal is being received at full volume with the AFC switch in the off position.

To understand how this motorboating comes about, it is necessary to correlate the following facts: (1) the voltage output of the power supply varies in accordance with the audio output, decreasing for larger values of audio output because of the increased current drain; and (2) a change in the voltage output of the power supply changes the oscillator frequency because it affects the gain (mutual conductance) of the oscillator control tube. When a strong signal is being received, there is thus a sort of feedback between the audio output and the oscillator control tube through the power supply, in that a fluctuation in the audio output will cause the power supply output voltage to change, which in turn changes the oscillator frequency. The change in the oscillator frequency in turn changes the audio output so that the feedback path is complete and the possibility of motorboating exists.

You will not often run up against this problem because AFC-equipped receivers are designed so as to minimize this effect. In a number of receivers the oscillator control tube and the power output tubes are fed from different parts of the power supply, in this way keeping the oscillator control tube voltage more or less independent of changes in the current drawn by the output tubes.

In at least one make of receiver (see Fig. 71) the voltages for the control tube are obtained through an entirely separate and distinct filter system which is connected to the filament winding of the high voltage rectifier. This circuit arrangement is expressly designed to minimize the possibility of motorboating as a result of feedback through the power supply.

Dial Switch.

In connection with the effect just described, it should be mentioned that most receivers equipped with AFC and an automatic or semi-automatic tuning mechanism have two separate AFC switches. One of these is the usual manual switch which makes possible the choice of regular or AFC operation. The second AFC switch is generally mounted on the automatic tuning assembly and makes contact momentarily

just as the tuning condenser comes to rest, so as to short the AFC control voltage. The need for this arrangement can be understood from a study of Fig. 101 in which it is made clear that the AFC action tends to keep the receiver tuned in on a channel even though the condenser setting may be off by more than 10 kc. It follows that as the tuning condenser passes through a signal channel just before coming to rest, this strong signal would tend to keep control and prevent the reception of a weaker signal on the channel to which the receiver is tuned. By shorting the AFC voltage momentarily, this control is lost and it becomes possible to receive the desired station. Incidentally, cases have been reported where insufficient clearance in the contacts of this switch has shorted out the AFC action completely; where this complaint occurs, check the contacts and if necessary increase the clearance by dressing the points.

Aligning with the Rider Chanalyst.

Complicated AFC discriminator circuits may be rapidly and accurately aligned with the Electronic Voltmeter in the Rider Chanalyst.

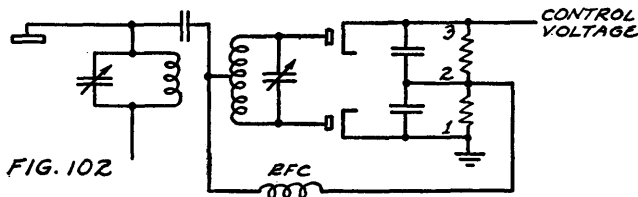

FIG. 102

Fig. 102.

A typical AFC discriminator circuit is shown in Fig. 102. To align, proceed as follows:

1. With the AFC switch off, tune the receiver to a strong broadcast signal. (Or connect the signal generator to the mixer grid and feed a strong signal at the intermediate frequency to this grid.)
2. Turn on the AFC switch.
3. Connect the Chanalyst Ground clip to ground.
4. Place the Voltmeter probe on (2).

5. Adjust the trimmer condenser on the primary of the discriminator transformer until a maximum voltage is indicated at (2). (This is done to make certain that the AFC system is operative.)
6. Place the Voltmeter probe on (3).
7. Adjust the discriminator transformer secondary trimmer until the voltage reading at (3) is zero. The AFC circuit is now properly aligned.

In some AFC circuits, such as that shown in Fig. 67, (1) is not at ground potential, but is connected through a resistor to a point negative with respect to ground. In such circuits, proper alignment is achieved when the voltage at each cathode of the discriminator tube is the same. This voltage will not be zero. Such circuits are checked by placing the Voltmeter probe at points corresponding to (1) and (3) and adjusting the discriminator transformer secondary trimmer until the voltage at (1) equals that at (3). The circuit is then properly aligned.

ADV Plans, LLC

Copyright Notice:

The entire contents of this CD/DVD are copyright 2014 by ADV Plans, LLC. All Rights Reserved.

Reproduction or distribution of this disk, either free or for a fee is strictly prohibited. We actively monitor and remove listings on eBay thru Vero.

You are free to copy or use individual images in your own projects, magazines, brochures or other school projects.

Only the sellers listed here are authorized distributors of this collection:
www.theclassicarchives.com/authorizedsuppliers

Please view our other products at
www.theclassicarchives.com,
or our ebay stores:

[TheClassicArchives](#)
[ADVPlans](#)
[SuperShedPlans](#)

