

**RECEIVING TUBE  
SUBSTITUTION  
GUIDE BOOK**

**BY**

**H. A. MIDDLETON**

**FIRST EDITION**



**JOHN F. RIDER PUBLISHER, INC.  
480 CANAL STREET NEW YORK 13, N. Y.**

Copyright 1950 by

JOHN F. RIDER

First Printing, December, 1950  
Second Printing, December, 1950

*All rights reserved. This book or parts thereof may not  
be reproduced in any form or in any language  
without permission of the publisher.*

Printed in the United States of America

## FOREWORD

*Receiving Tube Substitution Guide Book* is a greatly enlarged and revised edition of the book *Wartime Radio Service* published in 1944. This new book lists about 750 receiving tube types and their bases, including all of the following series:

- 4, 5, 6, 7, and 7L old-style base series
- Octal base series
- Loctal base series
- 7-pin miniature series
- 9-pin-noval series
- Subminiature series.

During the past eight years we have made many tube substitutions. Most of them were easy to make and all resulted in from excellent to reasonable performance. The majority of substitutions shown here have actually been tried. We are passing this information on to you in the belief that it will save you many hours and enable you to make necessary repairs to electronic equipment in spite of shortages. Also, when shortages no longer exist, you will again save time in restoring equipment to its original condition after substitutions have been made.

All substitutions listed here describe in detail the necessary data for changing or rewiring the sockets. It is recommended that in making the circuit changes listed you follow the sequence exactly as indicated in order to avoid any errors in rewiring.

You will note that a few types have no substitutes listed. We do not presume to be infallible. We may have omitted some tube substitutions. If you know of tube substitutions which have been omitted we would like to hear from you about them.

Besides a tube substitution listing we have included other important information that will make this book

even more useful as a substitution guide. In Section 3 we offer a compilation of television receiver filament circuit arrangements including various filament diagrams. These were compiled by John F. Rider Publisher, Inc., to whom we owe thanks for their contribution. The information was taken from the five presently existing Rider TV Manuals. It is hoped that this information will not only aid tube substitution operations, but will prove helpful in connection with TV servicing in the home. A group of servicing suggestions are also included to help in repairing the filaments of burned-out tubes, making adapters, and for the change over of battery-operated radios to electric operation.

Most significant is the last section of this book which covers different charts and tables. A complete listing of the characteristics of receiving tubes and bases and cathode-ray tubes and bases are included in this section. Thus this book, besides serving as a tube substitution guide, also functions as a tube handbook.

We wish to express our appreciation to the American Radio Relay League for their cooperation in permitting us to reprint their receiving tube characteristics charts from their ARRL handbook. In our estimation these are the most complete charts available at this time. To Tung-Sol Lamp Works, Inc., for supplying us with the data on tube classifications, ballast tube and resistor numbering codes, and RTMA resistor, capacitor, and transformer color codes our thanks; also to Sylvania Electric Products, Inc., for supplying us with the data on cathode-ray-tube characteristics; to Federal Telephone and Radio Corp. and Radio Receptor Corp. for their kind cooperation.

November, 1950

H. A. MIDDLETON

# TABLE OF CONTENTS

	PAGE
SECTION 1 - THE BACKGROUND OF TUBE SUBSTITUTIONS . . . . .	1
SECTION 2 - RECEIVING TUBE SUBSTITUTION GUIDE . . . . .	30
SECTION 3 - TELEVISION RECEIVER FILAMENT CIRCUIT ARRANGEMENTS . . . . .	145
SECTION 4 - SERVICING SUGGESTIONS . . . . .	170
SECTION 5 - CHARTS AND TABLES . . . . .	173
RTMA Receiving Tube Ratings . . . . .	173
Receiving Tube Bases . . . . .	175
Receiving Tube Characteristics . . . . .	181
Cathode-Ray-Tube Bases . . . . .	202
Cathode-Ray Tube Characteristics . . . . .	204
Cross Index of Army VT Numbers and Commercial Numbers . . . . .	211
Ballast Tube and Resistor Numbering Codes . . . . .	213
RTMA Capacitor, Resistor, and Transformer Color Codes . . . . .	214
Pilot Lamp Table . . . . .	215
Germanium Crystal Diode Characteristics . . . . .	215



# SECTION 1

## THE BACKGROUND OF TUBE SUBSTITUTIONS

Were it not for the fact that tube development is a never-ending activity, there would be no purpose in describing the background of tube substitution. The substitution lists contained herein would suffice, for they include practically every tube which is used for receiving purposes serving many different electronic applications. These applications consist of radio receivers of all varieties (a-m, f-m, and TV), radar, facsimile (commercial and military), public address amplifiers, record changer amplifiers, test equipment, electronic computers — in fact every kind of equipment with the exception of transmitters, although even there, receiving tubes make their appearance in the speech amplifiers.

The basis of tube substitution is *similarity* or equivalence between the original and the substitute. The choice of these two words with different connotation is deliberate; similarity may mean equivalence in some respects but not in all. Thus if two tubes are similar (or identical) in electrical characteristics, one is the equivalent of the other. The use of two tubes, however, to replace one single tube which affords certain facilities, creates a state of equivalence rather than a state of similarity.

This is not intended as a play on words but deals with a very important situation that is developing fast in television receivers. Unwelcome as it may be, it means constructional modifications and even more important, a careful analysis of what suits the purpose. Any attempt to list all the substitutes within the meaning of equivalent as we have described it, would be a monumental task and would more than likely, never see the light of day. We hope, therefore, that the general details of the background of tube substitution given in this section combined with the tube substitution lists and the knowledge possessed by the technician who makes the change (and selects the substitutes) will result in satisfactory substitutions.

An examination of the tube substitution lists will disclose that the substitution of one type for another is not too frequently accomplished by a simple replacement of tubes. Differences in tube characteristics may demand some modifications in the circuit within the apparatus. Sometimes, only a change of socket is needed because of differences in the basing of the substitute tube. In other instances, definite restrictions

are imposed relative to the heater circuits; some substitute tubes may be used only in parallel-wired heaters without any circuit changes, whereas in other instances, a tube substitution is applicable only to series-wired heaters. In some cases, a tube substitution may demand modifications in the cathode, control grid, plate, or screen circuits, or possibly in the power supply, so as to satisfy the needs of the substitute and accomplish the best possible performance. These circuit changes are not listed because they are peculiar to each system.

All of this means that although the lists in this Guide Book give the substitute or substitutes as the case may be, the final selection cannot be made without considering the conditions existing in the equipment which will receive the substitute. Where changes in heater or filament wiring are required, they are described. Changes necessary in the signal electrode circuits such as those of the control grid, screen grid, cathode, and plate so as to attain best possible performance become the function of the technician and are determined by the constants of the specific circuit in which the substitution is made.

As shown in the three series of Rider's Manuals (AM-FM, TV, and PA), many tens of thousands of models of receivers and amplifiers comprise the hundred odd million units which may require substitute tubes.

Fortunately, a certain amount of standardization does exist in receivers and other equipment designed to work with the tubes listed herein. This situation, together with the circuit and operating voltage details given in the above-mentioned manuals and manufacturers' literature affords the technician the opportunity of determining the operating conditions thereby enabling him to establish the correct voltages at the different signal electrodes. A familiarity with these techniques is not difficult to acquire, although we hasten to add that too many differences exist to permit circuit modifications based on guesswork or memory. Schematic wiring diagrams, operating voltage tables, and the tube characteristic charts demand attention if longest tube and component life are desired, and also, if best circuit performance is to be attained with the substitute tube.

Design engineers have their own ways of accomplishing performance with the standard run of tubes. Many substitutes are possible but all will not afford like performance. In listing the substitutions, only those sub-

stitutions considered practical, that is, which do not demand redesigning of circuits, were included. Many substitutes possess sufficient similarity to the original as to require no changes in either heater wiring or sockets. These are listed with the note "No changes." This does not mean, however, that the signal electrode operating conditions are identical for the original and the substitute. This should be checked in the tube characteristics chart contained in this Guide Book. It only requires a few minutes of time to do this and its results can be very gratifying.

If upon examination, the differences in electrical characteristics between the recommended substitute and the original are more than moderate, changes in the signal electrode operating circuits may be required. Since the plate voltage requirements for tubes in similar categories do not differ greatly, changes are not too frequent in the plate circuits. It is only when battery type and a-c operated tubes are being compared that one finds radical differences in plate and screen voltages. More critical points are the control grid and cathode bias — especially the latter. Small numerical differences in bias voltages (which are related to the plate current) produce great performance differences. For example, a change in bias from  $-2$  volts to  $-4$  volts is only  $\frac{1}{2}$  volts, but it represents a change of 100 per cent, and can very materially influence performance. A situation of this kind would demand a change in the value of the bias resistance.

A bias tube may be listed as the substitute for a zero bias tube. Reference to the electrical characteristics will disclose that the grid resistor must be changed; sometimes from 10 megohms to as low as 0.25 megohm. In addition, a cathode resistor of such ohmic value as will develop the bias shown in the tube characteristic chart must be added. Thus, the statement "No changes," does not refer to signal electrode operating conditions, rather to the fact that neither heater wiring nor socket changes are required.

Each substitution is an individual case requiring individual consideration, unless it is definitely known that the original and the substitute are identical in all respects other than heater voltage. Even then, if the substitution is made in a system which involves a state of resonance, realignment will be required. Similar tubes, even identical ones, do not possess identical values of interelectrode capacitance. This difference affects the final value of tuning capacitance. It is very important to bear this in mind when substitutions are made in wideband amplifiers particularly, since here, the interelectrode capacitance (direct and reflected) plays a paramount role in the peaking action. Examples are the video amplifiers in television receivers and the amplifiers in oscilloscopes and the like. In making substitutions it is often necessary to consider the function of the tube and its circuit so as to insure best performance in the circuit. The various types of circuits and functions will now be discussed.

## Oscillator Systems

These may be heterodyning arrangements which involve tracking with other tuned circuits, such as in converter systems and separate oscillator and mixer circuits, or nontracking arrangements, such as beat-frequency oscillators. Also, there are the various kinds of multivibrator systems in television receivers. Each of these demands individual consideration.

Combination oscillators and mixers (converters) require substitutes which contain not only the identical number of electrodes as the original, but in addition, the functions of these electrodes must be the same. This immediately limits the number of possible substitutes. The list of tubes, classified by function found at the end of this section, is an aid in this respect. If the required substitutes can not be procured, it does not make sense to redesign the circuit so as to replace a single tube with two individual tubes. That is a design engineer's job. If the oscillator and mixer functions are performed by individual tubes in separate envelopes, then the latitude of substitution is greater, provided that the selection of the substitute tube is made carefully.

The higher the frequency of operation, the more critical is the choice. That is why new tubes are born as operating frequencies increase. Tubes designed for the broadcast band are frequently unsuited for use in the vhf band and most certainly not in the uhf band. Thus, in addition to recognizing the oscillator function, it is also imperative to pay heed to the frequency of operation. If a choice is available, the tube intended for a higher frequency is suitable for a lower frequency, but not vice versa with complete freedom.

Sometimes tubes specifically intended for use as oscillators will not perform properly in that position, it is difficult to account for this, but it is a fact nevertheless. This does not condemn the tube as a tube — it can still perform other functions — nor does it mean that another tube of like brand and type will behave in similar fashion. There is no remedy for such failure to function properly — it is simply a statement of fact.

What should be examined when comparing tubes intended for oscillators? Neglecting heater or filament ratings for the moment, these being assumed to be suitable and assuming that the number of circuit electrodes of the substitute original are the same, such details as the grid bias, the plate (and screen) voltages, the plate (and screen) currents, and the transconductance are paramount factors. If the exact duplicate is not available, the substitute tube which requires lower plate and screen voltages (differing only moderately from the original) is preferable to the substitute tube which requires higher plate (and screen) voltages than the original. The tube with the higher transconductance is preferable to the tube with the lower transconductance, everything else being equal. These preferences are more apt to furnish heterodyning voltage

## RECEIVING TUBE SUBSTITUTION GUIDE

over the entire band embraced by the receiver, especially if the bias resistor is modified to suit the specifications of the substitute.

### R-F and I-F Amplifiers

The general run of r-f and i-f amplifiers utilize tetrodes and pentodes. Since pentodes used as triodes (in a-f amplifiers) are substitutes for triodes, it is important when selecting a substitute to know the manner in which the tube is used in the r-f or i-f amplifier. A triode is a poor substitute for a pentode; if a pentode is used, the substitute should be a pentode. However, if a tetrode is used, the substitute may be either a tetrode or a pentode. Care should be exercised to note if a shield is a part of the tube. An unshielded tube may be substituted for a shielded tube provided that an external shield is used and is grounded properly. Single-ended tubes may be substituted for double-ended tubes, but the reverse may be troublesome. Care must be exercised relative to the control-grid lead dress so as to minimize regeneration.

Sharp cutoff tubes should be replaced by similar tubes; similarly with remote cutoff tubes. However, sharp cutoff tubes may be replaced by remote cutoff types without too much trouble. The avc may be affected somewhat, but this does not interfere with the effectiveness of the receiver. When sharp cutoff tubes replace remote cutoff types, however, some minor problems may arise. Their best location would be in places where the signal level is lowest, for example, in the first stage in either an r-f or i-f amplifier. If distortion is severe on loud signals (due to rectification in the sharp cutoff stage), a divider network may be required so as to reduce the avc bias being applied to the sharp cutoff tube. This is best accomplished at the source of the avc, and might call for a separate avc line to the sharp cutoff tube. It might even be satisfactory to operate the sharp cutoff tube (if it is located at the point of lowest signal level in the amplifier) without any avc, using a low fixed bias.

Where there is a high input signal, sharp cutoff tubes must be used in place of remote cutoff tubes, an auxiliary volume control (or divider) at the front end of the receiver (perhaps in the antenna circuit) may be required. This would be operated only on those channels which cause trouble. A panel switch would control the operation of this signal control element.

Transconductance is the important electrical characteristic to consider in r-f and i-f amplifier substitutions. The higher the mutual conductance is relative to an r-f or i-f transformer the better, assuming that the plate and screen voltage conditions are satisfied or approached. Inability to equal the original tube in transconductance means reduced gain in the stage, but this seldom is a problem in a-m or f-m receivers because the average receiver has excess gain for the reception of chain or local broadcasts. The same can be

said about television receivers, provided that the receiver is located in a primary service area. When such a receiver is relatively close to a station, the problem is too much rather than insufficient signal, so that a reduction in r-f or i-f amplification (unless it is too severe) usually can be tolerated. In fringe areas, the situation is different, especially when the received signal levels already border on the inadequate. There it becomes necessary to approach the original, and if this cannot be attained, then it is preferable to select tubes with higher than the original transconductance and to adjust the operating voltages accordingly. General instructions of this kind are given elsewhere in this section.

Where r-f and i-f systems are subject to tube substitutions, realignment of the coupling transformers associated with the input and output circuits of the substitute stage are imperative. Sometimes it may appear that proper performance is being secured without realignment. This should not be accepted as fact without a test to establish if the circuits are peaked properly.

Whether the shift in frequency peaking is upward or downward depends upon the direction of the capacitance change. A reduction in distributed capacitance, which includes the plate-to-cathode (or control grid-to-cathode) capacitance tends to cause peaking at a higher frequency, whereas an increase in distributed capacitance tends to cause peaking at a lower frequency.

Many i-f transformers and some r-f transformers are permeability tuned, utilizing the related distributed capacitance including the tube capacitance to provide the  $C$  for the tuned circuit. Because of this, changes in distributed capacitance, due to different tube electrode capacitances, can cause major variations in operating conditions. Whenever possible, substitute tubes should approximate the input-output capacitance of the original tube. This data is found in the tube specification charts of Section 5.

Exception to the need for realignment of r-f and i-f coupling systems is found in those equipments which employ  $R-C$  coupling between tubes. While not a common practice, it is to be found in receivers. Sometimes the coupling element consists of a resistive plate load and a tuned grid load for the succeeding tube. The resistive plate load on a substitute tube requires no readjustment, but if the substitution is made in that stage which has a tuned grid load, realignment will be required. Examples of such arrangements are listed elsewhere in this section in connection with r-f and i-f transformer replacement.

### Audio Amplifiers

All types of tubes are found in audio amplifiers: triodes, tetrodes, pentodes, pentodes used as triodes, and various kinds of output-stage power amplifiers. Voltage amplifiers are, in the main, resistance-coupled

## RECEIVING TUBE SUBSTITUTION GUIDE

systems, whereas power amplifiers are transformer-coupled. The difference between these two general categories is the plate circuit load, that is, load impedance, and the grid bias.

There are some differences between the signal electrode operating conditions in resistance-coupled amplifiers, their operating voltage or load resistance may differ, but many substitutions are possible without changes. A fair degree of similarity exists between the fundamental designs of these circuits so that it is possible to generalize concerning substitutions. Pentodes can be used in place of triodes and, in turn, triodes may replace pentodes or tetrodes. The load resistances are pretty much the same for all of these tubes since the limitation is set by the plate voltage supply, and this does not differ too greatly in like categories of equipment. Naturally, the ideal condition is when the substitute is used exactly as the original, or the substitute type is the same as the original type.

In the case of triode-type tubes used in audio amplifiers, with the exception of the output stage, the amplification constant of the tube is the pertinent factor. The higher the amplification constant, the higher the stage gain, provided that the internal plate resistance is not too high relative to the load resistance. The higher the internal plate resistance of the tube, relative to the load resistance, the less the amount of signal taken out of the tube will be. The portion of the available signal taken out of the tube is expressed as

$$\frac{R_l}{R_p + R_l}$$

where  $R_l$  is the load resistance in ohms and  $R_p$  is the internal plate resistance expressed in ohms.

Another matter of concern to keep in mind is that relating to grid bias. Quite a few tubes used in  $R-C$  coupled amplifiers as well as in  $L-C$  coupled systems are of the zero-bias type. When adequate substitutes are not available and a self-bias tube is used in place of a zero-bias one, provision for the bias must be made in the circuit. This can be in the form of a bypassed cathode resistor. In addition, the grid resistor (grid leak) of the substituted stage will require reduction to perhaps one-thirtieth or one-fortieth of its original value. Zero-bias tubes utilize grid resistors of from 5 to 10 megohms. Self-bias amplifier tubes utilize grid resistors of from 0.1 to perhaps 0.3 megohms. These bias- and grid-resistor references will be found to apply to pentodes and tetrodes as well as triodes. When a zero-bias tube is used in place of a self-bias tube, the above-required changes in circuits are reversed.

In the output stages, for that matter, also in driver stages in audio amplifiers, attention must be paid to the recommended load impedance represented by the output transformer. Not only does it determine output power, which may or may not be important, but it also determines the quality of reproduction. The latter is important.

To begin with, the recommended load impedance for substitute tubes should be the *same* or *less* than that for the original. By being less than the original a fair semblance of the original quality will be retained because the tubes are working into a higher impedance, that represented by the output transformer already in the device. Power output will be reduced somewhat but quality of reproduction will be retained. If it is impossible to find substitutes which require the same, or a lower load impedance than the original, then a higher rating will have to be accepted, but it should be the closest approximation to the original.

A receiver installation can afford to sacrifice some power for quality. In public address systems, it is a question of how the system is used. If its full-rated power output is seldom used, then it can sacrifice some output for quality. If it is used for the reproduction of speech only, it can afford a greater mismatch than systems which reproduce music and speech. In the last analysis it is a compromise and each individual requirement determines the choice.

In view of the power-handling requirements of the output stage, only those substitutes, both triodes and pentodes, are usable which can handle power. These are interchangeable but only on that basis.

When two individual tubes are used in a push-pull output stage and a substitution is being contemplated for one tube, it should be carried out for both. If the characteristics of the original and the substitute differ markedly, parasitic suppressors may be required in grid and plate leads (if they are not already in the circuit). Fifty-ohm resistors capable of handling the currents involved are adequate. If two individual tubes replace two tubes in a single envelope, such resistors may prove very important because the changes in wiring and lengthening of the leads may cause oscillation.

Negative feedback is used in many audio systems between the output power stage and a preceding stage. Tube substitutions can upset the feedback conditions, especially if the electrical characteristics of the substitute are unlike the original. If audio quality or power over-all gain seems to have suffered too much, the feedback circuit should be checked.

When tube substitutions in a-f driver stages are contemplated, the range of substitutes is more limited than in the case of voltage amplifiers. While tubes designed for the driver stages of a-f amplifiers may be used in other capacities, tubes designed for other functions very often are not usable in a driver stage. Because the tube grid in the driver stage is driven into the positive region during certain portions of the signal cycle, the tube which feeds the driver-stage input transformer must be of the correct type for operation with the driver-stage input transformer. In like manner, the driver stage is impedance-matched to the transformer which feeds the succeeding stage. This is another requirement that must be satisfied when the substitute tube is selected from a number of types which possess

## RECEIVING TUBE SUBSTITUTION GUIDE

the required over-all similarity in electrical characteristics.

### Phase-Inverter Stages

Phase-inverter stages present no serious problems in substitution except for the fact that differences between the original and the substitute may demand readjustment of the load resistor so as to arrange that the signals from the phase-inverter stage to the control grids of the succeeding push-pull stage are of like magnitude. If the phase-inverter stage serves just one function, inverting the signal to one of the succeeding push-pull stage tubes, and it is of the same type as its related amplifier tube which feeds the other succeeding push-pull tube, then it may be convenient to *substitute like tubes for the phase inverter and its related amplifier.*

### Diode Rectifiers (Signal)

Too much need not be said about signal-rectifying diodes. One significant detail is that power rectifiers are not substitutes for signal rectifiers. (They are not shown as substitutes on the list, but the comment is still required.) There is very little to choose from between signal-rectifying diodes for virtually anyone will perform the functions of the others, except perhaps in connection with frequency of operation. The transit time (time taken for the electrons to advance from cathode to plate relative to the period of a cycle of the signal) limits the application of the tube in terms of frequency. Uhf diodes are suitable for operation at lower frequencies. On the other hand, the low or conventional frequency diodes are not suitable for the rectification of uhf and sometimes even vhf signals, unless so specified.

It is interesting to note that the equivalent of conventional signal-rectifying diodes may be formed out of conventional triodes by tying the grid and plate together thus forming one element, or by tying the plate to the cathode and using the control grid as the second element. Such equivalence is not indicated in the list of substitutions, but it should be kept in mind.

Sometimes multipurpose tubes used in receivers do not employ all of the electrodes. Quite frequently a duo-diode may have its two plates tied together forming a single diode to be used for a single purpose. It is well to try to disconnect one of the plates and to see if the operation is impaired; if not, then the other diode plate may, in conjunction with the common cathode, be used as the substitution diode. Whether or not such is possible depends upon the manner in which the common cathode is being used.

New advances in the design of germanium crystal diodes facilitate the use of these components as replacements for conventional diode tubes in signal-rectifying and detecting circuits. An important consideration in

this connection is the fact that they require no heater supply and have an average life of over 10,000 hours.

Germanium crystal diodes are usable in vhf and even uhf circuits since their maximum operating frequency is about 500 Mc. They are rated for voltages of from 25 to 200 volts, with peak anode currents up to 200 ma. These components are particularly suitable for detector circuits where their low shunt capacities (of the order of 1 mmf) are advantageous.

The substitution of a crystal diode for a conventional-type tube is particularly simple because there is no need for a heater supply circuit. A typical use of a 1N34-type crystal diode is illustrated in Fig. 1-1.

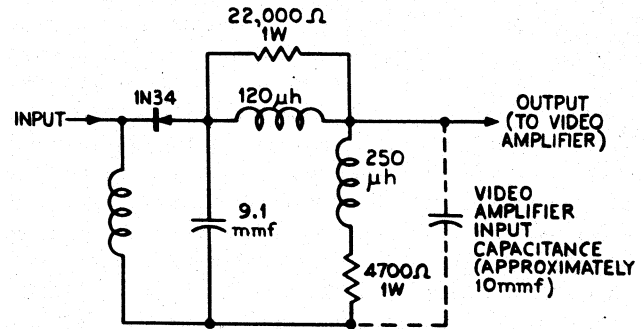

Courtesy Sylvania Electric Products Inc.

Fig. 1-1. The use of a 1N34 type germanium crystal diode in the video detector circuit of a television receiver. Notice that the value of the circuit parameters are similar to those found in most video detector stages.

Here the component is shown being used in a video-detector circuit of the type common in most television receivers. The performance of the circuit with the 1N34-type crystal diode depends upon the proper choice of circuit parameters. In most circuits, however, it will be found that there need be no component modifications for good performance. Conventional-type tubes for which germanium crystal diodes are successful replacements are the 6AL5, 6H6, 6T8, and 12AL5. In the replacement of duo-diodes not only must the detector function be taken care of, but the sync limiter or other use must also be replaced. This is possible by using a 1N35-type matched duo-diode crystal component. See the table of germanium crystal diodes in Section 5.

For further information as to the use of germanium crystal diodes in video and f-m detector circuits as well as in other signal rectifiers, see *40 Uses for Germanium Diodes*, a booklet obtainable from Sylvania Electric Products, Inc.

### Diode Rectifiers (Power)

Power rectifiers are of two types, high-vacuum and gaseous. Normally, high-vacuum rectifiers are interchangeable as are gaseous ones, within the limitations set by the current and voltage ratings of the device.

## RECEIVING TUBE SUBSTITUTION GUIDE

Gaseous-type rectifiers frequently may replace vacuum-type rectifiers provided that the electrical characteristics are the same and the related circuit requirements are satisfied. Replacement of high-vacuum rectifiers by the gaseous kind is not recommended except when high currents are involved and when a constant voltage drop in the rectifier is required; the need for high voltage alone is not sufficient.

To take a typical case, the mercury-vapor rectifier requires choke input instead of capacitor input in the filter system. The high current surges which occur with capacitor input would destroy the gaseous tube. Also, gaseous tubes are suitable for the rectification of medium voltages and higher (500 volts output and up) and they are intended for systems wherein high current loads exist and where the variations in current load are large. In the case of a-c—d-c receivers, there are no gaseous equivalents for the high-vacuum types used. Gaseous rectifiers, moreover, are a source of r-f "hash" and, therefore, are not suitable for use in close proximity to circuits susceptible to such radiations.

High-vacuum tubes, on the other hand, are suitable replacements for mercury-vapor rectifiers if the rectifier system can stand the increased voltage drop which occurs in the high-vacuum tube and if the electrical requirements are satisfied. As a rule, the heater current for high-vacuum rectifiers is less than that required for gaseous rectifiers of comparable d-c voltage and current output. Other important electrical requirements to consider are the a-c input voltage, output current, and inverse peak voltage. The last-named term expresses the ability of the tube to withstand the peak voltage between the anode and the cathode during the nonconducting portion of the cycle.

Assuming the lack of recommended substitutes, high-vacuum tubes are suitable for substitution in systems which operate at lower d-c output voltages and currents than the high-vacuum tubes are rated for, provided that the heater requirements are satisfied. Such substitution should be made only in extreme cases when no other means are possible and a system must be restored to operation. For that matter, in such an event, the mercury-vapor kind also can be used provided that there is a choke input in the filter system. This is a MUST condition.

The substitution of a filament-type rectifier for a cathode-type one introduces certain complications, especially when the remainder of the tubes in the system are of the cathode-heater variety. The difference in heating time would result in the very rapid build-up of the voltage output from the rectifier before the tubes receiving the plate and other voltages were in a conducting state. Thus, the rectifier would be operating for a period of time with practically no load. This results in a high output voltage — much higher than when the load is applied — and could very easily break down the filter capacitors and also some of the bypass capacitors in the equipment receiving its voltage from

the rectifier. Replacing a filament-type rectifier with a heater type causes no complications of this sort.

From a practical viewpoint it seems worthwhile to go to no end of trouble to find a suitable filament-type substitute for a filament-type original. This seems easier than changing the voltage rating of all of the filter capacitors and the bypass capacitors for high working voltage units. Of course, if examination of the capacitor voltage ratings and measurement of the rectifier output voltage shows that the momentary peak is within the operating voltage rating of the capacitors, the change can be made without endangering the filter and bypass units. If this is not the case and replacement of the filter and bypass capacitors is not feasible, then the only alternative is to use an increased bleeder load and thus reduce the over-all output voltage from the power supply.

For medium- and low-voltage requirements, selenium rectifiers are far more suitable substitutes for high-vacuum rectifier tubes than are gaseous tubes. Miniature selenium rectifiers are available in various sizes rated from 50 to 500 ma. The 50-, 65-, 75-, and 100-ma sizes will, in most cases, best serve as replacements for half-wave rectifiers in a-c—d-c equipment.

Generally speaking, to replace the vacuum-tube rectifier in a phonograph oscillator, use the selenium rectifier rated for 50 ma, for three-tube amplifiers use the 65-ma size, for five- or six-tube receivers without a push-pull output, use the 75-ma rectifier, and for six-tube sets and up use the 100-ma rated one. To replace the 25Z5, 25Z6, 35W4, 35Y4, 35Z3, 35Z4, 35Z5, 45Z5, 50Y6, and 50Z7, use a 403D2625A type selenium rectifier with a rating of 100 ma.

When a rectifier tube is replaced by a selenium rectifier, a compensating resistor must be inserted into the filament circuit to make up for the resistance drop due to the elimination of the rectifier tube if its filament was in series with other filaments. The value of this compensating resistor depends upon the rectifying tube that has been replaced. The following table lists the resistance to be used for the tubes mentioned above.

TUBE	RESISTOR (ohms)	WATTS
25Z5	85	15
25Z6	85	15
35W4	230	10
35Y4	230	10
35Z3	230	10
35Z4	230	10
35Z5	230	10
45Z5	300	10
50Y6	330	15
50Z7	330	15
117Z3	none required	
117Z6	none required	

In some sets, the pilot light may be connected across a low-voltage tap on the rectifier tube filament. If this



## RECEIVING TUBE SUBSTITUTION GUIDE

is so in the set in which the rectifier tube is being replaced, connect the pilot light across a tapped-down portion of the compensating resistor (about 10 to 25 ohms will do depending upon the current in the filament circuit). A No. 47 pilot light can be used in this case.

When replacing vacuum-tube rectifiers by selenium rectifiers in a-c—d-c portables using battery-type tubes that obtain filament voltages from B plus through a dropping resistor, reduce the value of the shunt resistor connected from the low end of the filament dropping resistor to the negative point. This will compensate for the increase in filament voltage.

In most cases, a protective resistor should be inserted in series with the selenium rectifier to protect the rectifier and filter capacitors from excessive current peaks during operation. The value of this resistor will vary from 5 to 50 ohms depending upon the current load of the rectifier; the higher the load, the smaller the protective resistor needed.

Manufactured adapters will probably be available for use with miniature selenium rectifiers in the future, in the meantime, they can be made fairly easily by using discarded tube bases. Following are instructions for making adapters for a few of the most popular rectifier tubes used in a-c—d-c equipment.

To make an adapter for the 35Z5 used in series circuits:

- a) connect a 230-ohm, 10-w resistor from No. 2 to No. 7 on an octal base
- b) connect a 20-ohm,  $\frac{1}{2}$ -w resistor from No. 2 to No. 3
- c) connect 25-ohm,  $\frac{1}{2}$ -w resistor from No. 8 to positive side of rectifier
- d) connect No. 5 to negative side of rectifier.

To make an adapter for a 35Z5 used by itself, follow the above steps but delete steps a) and b).

For the 25Z6, 25X6, 35Z6, 50AX6, 50Y6, and the 117Z6 when these tubes are used by themselves as half-wave rectifiers, make an adapter as follows:

- a) connect a 25-ohm,  $\frac{1}{2}$ -w resistor from Nos. 4 and 8 on octal base to the positive side of the rectifier
- b) connect Nos. 3 and 5 to negative side of the rectifier.

If the filaments of these tubes are in a series circuit, then naturally a compensating resistor must be added with the selenium rectifier. This resistor, whose value may be obtained from the table given previously, will be connected between pins No. 2 and No. 7. No resistor is needed when the 117Z6 is replaced.

### Wideband Amplifiers (Video and Others)

Although referred to earlier in this section, these systems are singled out for elaboration because of their seemingly peculiar conditions of operation. Ex-

amination will show that very low values of plate-load resistance are used and also that the applied plate voltage is very low, much lower than that shown in tube characteristic charts.

This is so because it is necessary to have wide frequency response. Gain in each stage is sacrificed for the attainment of low reflected capacitance and also the creation of suitable resonance.<sup>1</sup> By means of shunt or series peaking, or both, a wide band of frequencies can be amplified. (This is explained in detail in the book referred to in the footnote.)

Tube substitutions in wideband amplifiers, therefore, require very serious consideration. The substitute tube characteristics should approximate most closely the complete conditions existing in the original. Interelectrode capacitance is very important. Plate-current, grid-bias, and grid-circuit resistance ratings should be the same. Lead dress must be maintained as much as possible because changes in the position of leads will affect the frequency of resonance and thereby the over-all bandwidth of the system. This is very important if socket changes are required.

If possible, all stages should be replaced by like substitutes even if only one stage requires replacement. This is expensive but advantageous. If the facility to check frequency bandwidth exists, then it is possible to confine the replacement to only one stage, the one in which the original tube is bad. Make the frequency run, and if the response is satisfactory after the replacement in that stage, the other stages need not be changed. Such tests can be made by means of a square-wave generator or a sine-wave generator. Usually the limits of response are expressed by the lowest and highest frequency signals which are down not more than 3 db from the top. In some instances, the amplifier design is more critical and the over-all response is expressed in terms of only 1 db down from the top.

### Utilization of Sections of Multifunction Tubes

A number of tubes found in television and other equipments combine three and four sets of electrodes in a single envelope, thus performing three or four different functions. Direct substitutions for these tubes may not be available. In that event it is necessary to utilize two individual tubes containing such electrodes as will furnish the facilities originally contained in the single tube which is being replaced. For example, a triple diode-triode such as the 6T8 may require replacement. If the original is not available, pairs of substitutes must be used, for example, a 6AL5 and a 12AV6 or a 6AL5 and 6AQ6. These are the recommended combinations, other combinations of a double-diode with a double-diode triode, or single diode-triode

<sup>1</sup>J. F. Rider and S. D. Uslan, *Encyclopedia on Cathode-Ray Oscilloscopes and Their Uses*, John F. Rider Publisher, Inc., New York, N. Y., 1950, pp. 389-401.

## RECEIVING TUBE SUBSTITUTION GUIDE

will function satisfactorily. One of these tubes takes over the function of two diodes in the 6T8 and the other tube takes over the function of the remaining diode-triode.

Substitution of two tubes for one is not easy; it means adding sockets and perhaps even changing sockets on crowded chassis where space is at a premium. This requires planning of the socket location and the location of shunt and series resistors, so as to keep connecting leads short. But it can be done, and it is a vivid example of how tubes with more electrodes (and capable of more functions) than the original may be used in replacements so long as only the necessary number of electrodes are utilized. Also it is an example of how it may be necessary to utilize several substitute tubes to perform the function of one original. Incidentally, pairs of tubes which can be used in place of other multifunction tubes are listed in an addendum to the tube substitution list. Which combination of substitute tubes fills the replacement of a single original is a matter of individual circuit design. Very many possible substitutions of this kind exist, especially in so far as signal diodes are concerned.

### Tube Substitution Techniques

Heater circuits are very significant in connection with tube substitutions because tube types are organized in terms of heater voltage. Therefore, it is quite in order to show the techniques involved in arranging tube heater circuits so as to accommodate substitute tubes. Before discussing the methods, however, in fact even before speaking about heater ratings, it might be well to emphasize one very important point, *all heater ratings are interpretable in terms of resistance*. The ohmic value of a heater is the same when it is operated on direct current or alternating current. Any reference to heater voltage considers the d-c value and rms or effective a-c value as the same. Thus a tube heater rating of 6.3 volts means 6.3 volts d.c. or 6.3 volts rms a.c. The same applies to any other numerical rating. Note: *Many battery-operated tubes will not function properly on a.c.*

Heater current is treated in like fashion. A reference to 0.15 ampere or 150 ma means d.c. or a.c., the latter being the rms value. The rms value is used because it is responsible for the heating effect in filaments and to get equivalent heating in d.c. and a.c., the d-c value must equal the rms a-c value.

While the above statement is true in all conditions associated with resistance, it should not be assumed to apply to all a-c systems regardless of circumstances. For example, the d-c value of voltage is related to the peak value of an a-c voltage when insulation resistance is involved. This is important in the operation of capacitors and in connection with the insulation breakdown of rectifier tubes during the nonconducting portion of the cycle.

### Heater Ratings versus Heater Circuits

It is common practice among electronic equipment manufacturers to use certain kinds of tubes for certain kinds of equipment. For example, in most a-c—d-c equipment, the tube heaters are connected in series across the line. The same is true when such equipment is intended for battery-operated portable use (the three-way portables). Other equipments are designed for operation from the a-c power lines only and the heaters are arranged in parallel chains. Still other equipments use a combination of series-parallel systems, as for example, a-c—d-c television receivers.

Sometimes the series chain is singular; sometimes there are a number of chains connected in series-parallel between different points as shown in the schematics at the end of Section 3. In the parallel systems, several independent parallel chains are used. Usually the rectifiers are wired individually and, in the true sense, are series circuits. The remainder of the tubes are, however, in parallel, all being on one chain or divided among a number of chains fed from individual voltage sources. These too are illustrated in Section 3. Incidentally, the receivers included in that section represent practically every one produced and sold in the years 1938 through October, 1950 as contained in Rider's TV Manuals Volumes 1 through 5.

### Parallel Circuits

Parallel chains will accommodate tubes which require equal heater voltage; they will also accommodate tubes with heater voltage ratings which are *lower* than that being supplied to the remainder of the tubes. This is shown in Fig. 1-2. The current rating of the heater is a matter of secondary concern in parallel chains.

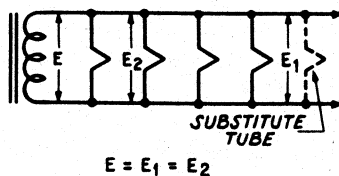

Fig. 1-2. Parallel connection of vacuum-tube heaters. The voltage drops across the heaters so connected are equal to the voltage across the secondary of the power transformer as shown.

If the supply voltage source (the heater transformer) is capable of supplying the required current at its rated output voltage, then any reasonable heater current requirement set by the substitute can be satisfied. The only limitation which exists relative to parallel connected heaters is that the output voltage rating of the heater transformer cannot be exceeded. The current through the parallel heater is determined by the resistance of the heater so that, if the voltage is correct, the current will be correct. If the current drain of the substitute heater added to the total current drain of the other tubes in the parallel chain exceeds the current output capabilities of the heater transformer, the



## RECEIVING TUBE SUBSTITUTION GUIDE

voltage will fall on all the heaters. It is possible to operate all receiving tubes at perhaps ten per cent below the normal voltage and current ratings. In special cases this reduction can be exceeded but it is not recommended.

Tube substitutes which bear heater voltage ratings lower than that of the original tube can be applied readily to parallel circuits. All that is needed is to *drop* the supply voltage to the level demanded by the substitute. The correction must be applied directly in the circuit which feeds the substitute tube. This is shown by the location of  $R$  in Fig. 1-3. The amount of volt-

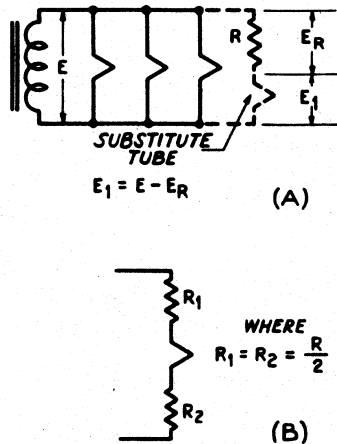

Fig. 1-3. When substituting a tube with lower voltage requirements than the original, a series resistor is added in the branch of the parallel feed in which the tube is placed. The resistor may be a single one as in (A), or two smaller ones as in (B).

age to be dropped is the difference between the supply voltage  $E$  and the tube heater requirement  $E_1$ . Suppose we wish to substitute a 2B7 with a 2.5-volt heater for a 6B7 whose 6.3-volt heater drew its supply from a filament transformer with an output of 6.3 volts. The difference  $E - E_1$  is 3.8 volts and this must be dropped at the heater current rating of the substitute tube, namely, 0.8 ampere. The value of the voltage-dropping resistor then is

$$R = \frac{E - E_1}{I} = \frac{3.8}{0.8}$$

or

$$R = 4.75 \text{ ohms or roughly } 5 \text{ ohms.}$$

The power rating of  $R$  is

$$P = I^2 R = 0.8^2 \times 4.75 = 3.204 \text{ watts.}$$

In the examples cited, the substitute imposes a load that is somewhat greater than the original; the power consumption of the 6B7 heater is 1.89 watts whereas that of the 2B7 is 2.0 watts. To this must be added the power dissipated across the voltage-dropping resistor  $R$ , for, after all, it is a part of the newly created load. Roughly, this amounts to 3 watts. So, the substitution of a 2B7 for a 6B7 means the imposition of a 5-watt load in place of the original 1.89 watts, or an increase in load of 150 per cent.

Normally, the addition of such a load will cause no trouble, but in the event that several tubes require sub-

stitution, the load may be increased to the extent that the voltage drop in the transformer secondary becomes excessive, and the voltage across all of the heaters will be lowered.

Some television receivers utilize a heater voltage supply which is the equivalent of two 6.3-volt windings in series, with the centertap grounded and acting as a common return path for two parallel chains of 6.3-volt heaters. This is shown in Fig. 1-4. Each winding furnishes 6.3 volts for its respective chain, but by virtue of a common center connection, the difference of potential between the extremes of the two windings is twice that of each, or 12.6 volts. Consequently, a 12.6-volt heater can be used by connecting it across the extremes of the windings.

Fig. 1-4. Filament circuit of the type found in many television receivers. The center tap between the two windings is grounded to serve as a return for the filaments in parallel, each of which receives 6.3 volts from its part of the secondary.

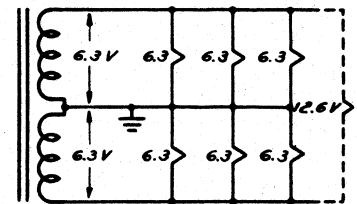

If necessary, more than one tube substitution can be handled in this way. The voltage between the extremes of the two windings is a maximum which cannot be exceeded, therefore, even such an arrangement does not permit the use of a tube which requires more than 12.6 volts (or whatever the voltage happens to be between the two extremes of the windings).

The number of 12.6-volt tubes which can be handled in the manner shown in Fig. 1-4 is not without limit. The power-handling capability of the two windings is the controlling factor. The substitution of a single 12.6-volt tube in place of a 6.3-volt tube is no problem especially when the power consumption is the same for both heaters; more than likely it will not cause any concern even if an increased load is created by the selection of some special type of 12.6-volt tube.

### Series Circuits

The substitution of tubes in series-wired heater arrangements hinges upon the following fundamentals of Ohm's law relating to series circuits:

1. In a series circuit there is only one path for the current.
2. The current in a series circuit is equal to the applied voltage divided by the total resistance.
3. The sum of the individual voltage drops in a series circuit equals the applied voltage.

Illustrated in Fig. 1-5(A) are four tube heaters connected in series across a voltage supply source  $E$ . Only one path exists for the flow of current  $I$ , therefore, the current must be the same in all parts of the circuit,

## RECEIVING TUBE SUBSTITUTION GUIDE

that is, in each heater. This immediately establishes the requirement that all heaters connected in series must have similar current ratings. A variation of 10 per cent in heater rating is permissible so long as the heater has a higher rating than the current required by the other heaters in the circuit.

Fig. 1-5. Filaments connected in series (A) may be represented as individual resistances (B), each of which passes the same current determined by the applied voltage divided by the total resistance.

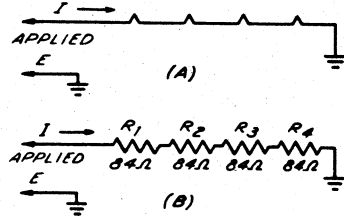

The numerical value of the current is dependent upon the applied voltage  $E$  and the total resistance  $R$  of all of the heaters, as stated in statement 2. above. Since resistances connected in series are additive, the total heater resistance  $R$ , is equal to  $R_1 + R_2 + R_3 + R_4$ , as indicated in Fig. 1-5(B). If, for the moment, we assume that each heater is rated at 12.6 volts and 0.15 ampere (150 ma), then the resistance of each is 12.6 divided by 0.15 or 84 ohms. The four heaters in series, therefore, represent a total resistance of 336 ohms. Knowing the total  $R$  and the required current, the supply voltage necessary to limit the current to the required value is

$$E = IR$$

or

$$E = 0.15 \times 336 = 50.4 \text{ volts.}$$

If the voltage drops across each heater (or the voltage required across each heater) are aggregated, it is seen that the sum of the voltage drops equals the applied voltage. Thus are illustrated statements 1., 2., and 3.

In view of what follows it might be well to devote a little more time to the matter of voltage drops and applied voltage, or the possibilities of statement 3. Current flowing through a resistance will cause a voltage drop across that resistance. If the current flow is the rated value, then the voltage drop numerically is the same as the voltage rating of the resistance. If the resistance is the heater (or filament) of a tube, and the current through it is the rated value, then the voltage drop is equal to the voltage rating of the heater.

We have simplified the problem by deliberately making the applied voltage (which we also can identify as the line voltage) equal to the total of the voltage drops in the load. As a rule, this is not found in practice; the line voltage always exceeds the total of the voltage drops across the tube heaters. This excess voltage is dropped by means of a line voltage-dropping resistor across which there is a voltage drop equal to the difference between the sum of the tube heater voltage drops and the line voltage. For example, if the line

voltage is 117 volts and the total of the tube heater voltage drops is 50.4 volts as in the above case, the line voltage-dropping resistor will drop  $117 - 50.4$  or 66.6 volts at the value of current which is flowing through the series chain.

Statement 3 still holds, except that now the series line voltage-dropping resistor has been added to the elements (heaters) which comprise the load. This action of the line voltage-dropping resistor may be considered from a different viewpoint. It is the means whereby the line voltage is dropped to that value which equals the sum of the voltage drops across the heater elements. This is not a play on words; it simply presents the relationship between the line voltage and the total heater drops from two angles relative to the purpose of the line voltage-dropping resistor. In one case, the line voltage-dropping resistor is considered a part of the load and, in the other, only the tube heaters are considered to comprise the load. Personally, we prefer the former and shall hold to it in these explanations.

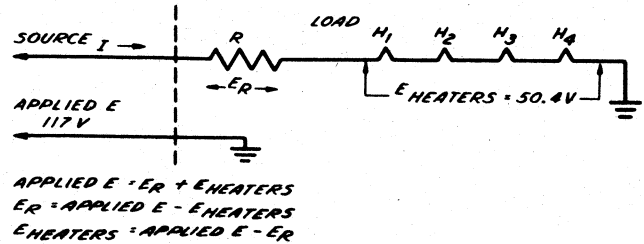

Fig. 1-6. A series chain of four filaments or heaters with a line voltage-dropping resistor. The voltage drop across the line voltage-dropping resistor makes up for the differences between the line voltage and the voltage required by the four heaters.

An example of the above is shown in Fig. 1-6. Here the elements of the load are shown to the right of the vertical dotted line and the applied voltage source is shown to the left. The series system indicates a total heater voltage drop of 50.4 volts at 0.15 ampere and a line voltage of 117 volts. The difference in voltage is dropped across the resistor  $R$ . Since the line voltage-dropping resistor is in series with the heater chain, the same current will flow through  $R$  as through the heaters. The voltage drop across this resistor is, therefore, a function of the current through it and its resistance. Since this voltage drop represents a dissipation of energy, the line voltage-dropping resistor bears a wattage rating in addition to its resistance rating. The power dissipation is a very important factor and must be taken into account in the event of any changes; in fact, it determines the type of resistor element which suits this purpose. The power dissipation in watts is expressed by either  $IE$ ,  $I^2R$ , or by  $E^2/R$ , where  $I$  is the current in amperes,  $R$  is the resistance in ohms, and  $E$  is the voltage in volts, exactly the same units as are used for the other Ohm's law calculations.

## RECEIVING TUBE SUBSTITUTION GUIDE

The ohmic value of  $R$  is

$$\begin{aligned} R &= \frac{117 - 50.4}{0.15} \\ &= \frac{66.6}{0.15} \\ &= 444 \text{ ohms.} \end{aligned}$$

Its power dissipation is

$$\begin{aligned} P &= E \times I \\ &= 66.6 \times 0.15 \\ &= 9.99 \text{ watts (approx. 10 watts)} \end{aligned}$$

or

$$\begin{aligned} P &= I^2 R \\ &= 0.0225 \times 444 \\ &= 9.99 \text{ watts (approx. 10 watts).} \end{aligned}$$

To prove these figures, the total resistance of the four heaters is  $4 \times 84$  or 336 ohms; adding this to the 444 ohms resistance of the line voltage-dropping resistor results in a total circuit resistance of 780 ohms. With a current of 0.15 ampere flowing in the system, the applied voltage is  $E = 0.15 \times (336 + 444) = 117$  volts.

Let us now examine the possible variables in a simple series chain of the kind shown in Fig. 1-6. Statement 3. of Ohm's law relates to an equality between the line voltage (applied voltage) and the total of the voltage drops in the load. No restriction is evident concerning the *number* of elements (tube heaters) which may comprise the load and across which the total of the heater drops will occur. In the system shown in Fig. 1-6, four elements comprise the heater load. These could be any number provided that the total voltage drop did not exceed the line voltage; if it equaled the line voltage, then the line voltage-dropping resistor ( $R$  in Fig. 1-6) would not be required in the circuit and the system would become the equivalent of Fig. 1-5(A), with more heaters than are shown there.

As a matter of fact, no matter what the total of the *rated* voltage drops across the heaters in the load is, this value can never exceed the applied (line) voltage, for statement 2. establishes that the current will adjust itself automatically in accordance with the total resistance and the total applied voltage. For example, if fourteen 12.6-volt, 0.15-ampere tubes were used in series across a 117-volt line, the total resistance would be 1,176 ohms. The current, therefore, would be

$$\frac{117}{1,176}$$

or 0.099 ampere, and the voltage drop across each heater would be  $0.099 \times 84$  or 8.3 volts. It is obvious that the voltage across these heaters would be insufficient for proper operation of the tubes. Correction of this state would demand a revision of the circuit or an increase in the line voltage; the latter is impractical, so the former is the only solution. It will be treated later.

On the other hand, the need may arise to substitute a lower voltage rated heater for a higher rated one,

such as a 6.3-volt tube for a 12.6-volt one. If the rated voltage drop across the series heaters is at least ten times the rated voltage drop across the substitute heater, the latter may be inserted into the string without requiring any correction. Thus, if the total rated voltage drop across the series heaters is 75 volts, and a 6.3-volt tube is a replacement for a 12.6-volt heater in the string, the replacement will be subject to a slightly higher voltage (and current) but it will do no harm.

For example, if the original series string consists of a 25-volt, 0.15-ampere tube and four 12.6-volt, 0.15-ampere tubes, the total resistance of these heaters is 502 ohms. Operation from a 117-volt line demands a dropping resistor of 227 ohms, making a total load resistance of 779 ohms. Substituting a 6.3-volt tube for the 12.6-volt one reduces the heater resistance to 460 ohms, and the total load to 737 ohms. This results in a circuit current of 0.158 ampere, and as a result, the 12.6-volt tubes are subjected to a voltage of 13.27 volts, the 6.3-volt tube to 6.6 volts, and the 25-volt tube to 26.4 volts. None of these voltages are so extreme as to endanger the tubes.

Battery tubes, however, should be treated with more care and every effort should be made to keep the voltage as close to the rated voltages as possible, especially when operation is intended on a-c lines.

Circuit conditions encountered in practice seldom are such that the total voltage drop across the heaters or filaments equals the applied or line voltage. The use of a line voltage-dropping resistor is very common, consequently, any change in the total voltage drop across the load caused by a substitution demands that the drop across the line voltage-dropping resistor be changed, and this means a change in its ohmic value. Whether the latter is done by shunting another resistor across it, by physically changing its length (as happens with line cords), or by substituting a new one of proper ohmic value for the original is determined by whichever is most convenient. If the total voltage drop across the heaters is *increased*, the drop across the line resistor must be *decreased*, and vice versa. A typical example follows.

Seven 6.3-volt heaters are in series with a 35-volt heater. All are rated at 0.3 ampere. The total voltage drop across the heaters is 79.1 volts and the total resistance of the heater load is 264 ohms as shown in Fig. 1-7(A). With a supply of 117 volts, 37.9 volts must be dropped across the line dropping resistor  $R$ . At 0.3-ampere current flow, the ohmic value of  $R$  must be 126 ohms and its power dissipation, therefore, is 11.3 watts.

Two 12.6-volt, 0.3-ampere tubes must be substituted for two of the 6.3-volt tubes. The modified circuit is shown in Fig. 1-7(B). Simple calculation of the total voltage drop across the heaters shows an increase of 12.6 volts, therefore, it is obvious that the value of  $R$  will have to be *decreased*. Its value may be determined

## RECEIVING TUBE SUBSTITUTION GUIDE

in a number of ways, but a simple procedure is the following

$$R_{\text{new}} = \frac{\text{Original value of } E_R - \text{Increased voltage drop across heaters}}{\text{Current through the system}}$$

$$= \frac{37.9 - 12.6}{0.3}$$

$$= 84 \text{ ohms.}$$

The power dissipation in the new  $R$  is

$$P = I^2 R$$

$$= 0.09 \times 84 = 7.5 \text{ watts.}$$

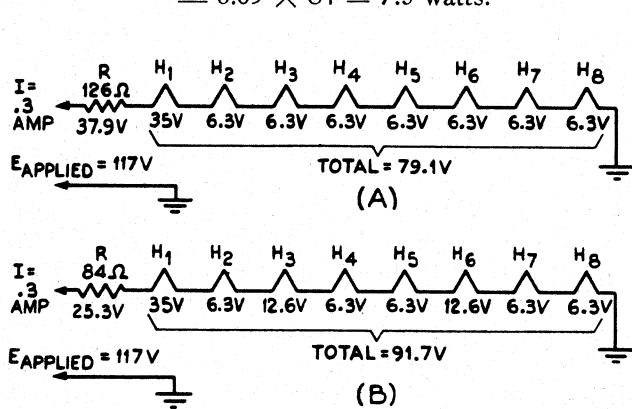

Fig. 1-7. In (A), a series chain of seven 6.3-volt heaters and one 35-volt heater requires a line voltage-dropping resistor  $R$  of 126 ohms to bring the applied voltage of 117 volts down to the value required by the heaters. When the total voltage drop across the heater is increased by 12.6 volts as in (B), the value of  $R$  must be decreased to 84 ohms.

### Substituting Low-Current Rated Heaters for Higher-Current Heaters

Suppose that in the circuit of Fig. 1-7(A) two 12.6-volt heaters rated at 0.15 ampere must replace two of the 6.3-volt 0.3-ampere heaters. Let us select  $H_3$  and  $H_6$  as the specific heaters. How would this be accomplished? Two methods are practical, one being simpler than the other. Suppose we treat the more difficult one first.

Since the circuit current is 0.3 ampere and each substitute heater draws only 0.15 ampere, it stands to reason that they just cannot be connected into the circuit as is, otherwise each would be subject to a 100 per cent current overload. However, two such heaters connected in parallel would require 0.3 ampere, and because of the division of currents in a parallel circuit in accordance with the resistance of each branch, connecting these two tubes in parallel would result in 0.15 ampere flowing through each heater. Moreover, the voltage drop across two elements in parallel is the same as that across a single element and, since the total drop across the two 6.3-volt heaters which are being replaced equals 12.6 volts, the two 12.6-volt heaters in parallel can replace the two individual 6.3-volt heaters without changing the total voltage drop across the

string of heaters. This is shown in Fig. 1-8(A). Note that the total drop across the string of 6.3-volt heaters originally [Fig. 1-7(A)] was 79.1 volts, and that the total drop across the heaters with the two parallel 12.6-volt substitutes is 79.1 volts. This means that the line dropping resistor  $R$  need not be changed since it is called upon to drop 37.9 volts at 0.3 ampere, the same as in the original circuit.

The other means of accomplishing the substitution is shown in Fig. 1-8(B). Instead of connecting the two

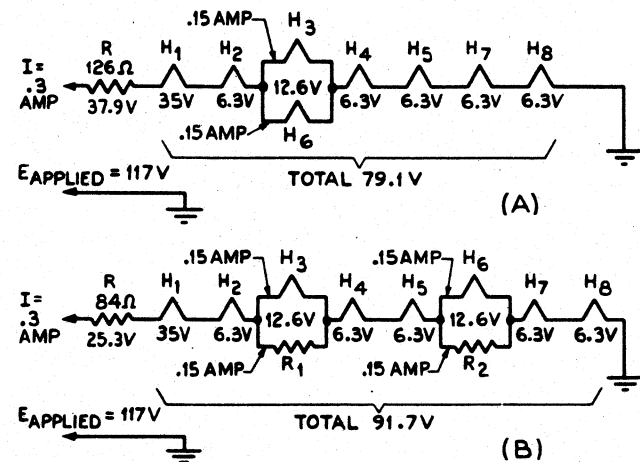

Fig. 1-8. Two methods of substituting 12.6 volt, 0.15-ampere heaters for 6.3-volt, 0.3-ampere ones are shown. In (A), both substitutes are paralleled together, splitting the current and keeping the voltage drop of the system intact; in (B), each heater has its own shunt, thereby drawing its rated current but increasing the total voltage drop of the heaters.

substitute heaters in parallel, they are treated individually and separate current shunts are connected across each one. Since it is desired to split the current equally between the heater and its shunt, the ohmic values of the shunts must equal the resistances which they shunt. This means that  $R_2 = 84$  ohms and  $R_3 = 84$  ohms, and each dissipates 1.89 watts. [See Fig. 1-8(B)].

However, handling these substitutions in this manner means that the total voltage drop across the string of heaters has been increased by 12.6 volts, since two 12.6-volt heaters in series total 25.2 volts, and two 6.3-volt heaters in series total only 12.6 volts. The increased drop of 12.6 volts must be compensated for by reducing the drop across the line resistor  $R$ . Figs. 1-7(A) and 1-8(A) are comparable, as are Figs. 1-7(B) and 1-8(B). In Figs. 1-8(A) and (B), the total line current of 0.3 ampere flows into the junctions of the parallel systems (the parallel heaters in (A), and the heaters paralleled by the shunt resistors in (B), divides equally between the two paths, and then recombines again to equal the 0.3-ampere line current. Thus, the 0.3-ampere, 6.3-volt heaters receive the proper current and so do the two 12.6-volt, 0.15-ampere heaters.

## RECEIVING TUBE SUBSTITUTION GUIDE

If four tubes required substitution and they were of like voltage ratings, two pairs of heaters could be paralleled as shown in Fig. 1-8(A). If there were an odd number of substitutions, two heaters could be located in parallel and the odd one would be operated with a shunt as shown in Fig. 1-8(B). As a matter of fact, it is the principle underlying these techniques rather than the actual number of tubes involved which is important. Once the principles are understood, it will be simple to apply them, and in general, the most convenient method should be used depending on the circuit and the components available. For example, the availability of resistors is a determining factor in deciding whether the line dropping resistor will be replaced or if two small resistors will be used for the current shunts. If the substitution demands new sockets, then paralleling of the heaters is no problem, but if the sockets do not require changing to accommodate the substitutes it is more convenient to use the current shunts.

### Substituting Higher-Current Heaters for Low-Current Heaters

Suppose the requirement is for the use of higher current heaters in place of lower current heaters in a series circuit. A single 0.3-ampere heater is to replace one rated at 0.15 ampere in a series string of five 12.6-volt, 0.15-ampere heaters and one 25-volt, 0.15-ampere heater. This substitution is to occur at  $H_6$  in Fig. 1-9(A). Several solutions are shown in Figs. 1-9(B) through (G). The choice is determined by which is most convenient and best fits the need. The one fundamental requirement created by such a substitution is that the total line current must be increased to 0.3 ampere so as to serve the increased current demand of the substitute tube. Whether this means that the line current will be limited to 0.3 ampere or increased above that value is determined by the organization of the heaters which form the load. One circuit system [Fig. 1-9(B) and (C)] needs 0.45-ampere line current, whereas other arrangements can be served by 0.3 ampere; there is no way, however, of satisfying the requirements of the 0.3-ampere tube with a line current of 0.15 ampere. For comparison, let us keep the constants of the original circuit [Fig. 1-9(A)] in mind. Here we have a total drop of 88 volts across the heaters, and 29 volts across the line dropping resistor at a current flow of 0.15 ampere.

One solution for the substitution is the use of two series paths, one for the 0.15-ampere heaters and the other serving the 0.3-ampere heater, as shown in Fig. 1-9(B). In order not to change the total voltage drop in the 0.15-ampere chain, a resistance (84 ohms) corresponding to that of the heater ( $H_6$ ) which has been removed is inserted in its stead. This establishes the total voltage drop at the original value of 88 volts and

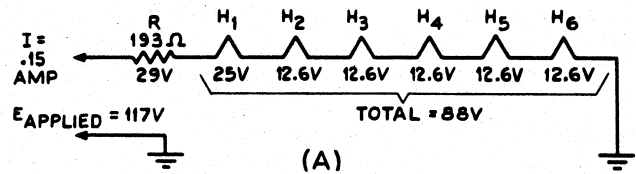

Fig. 1-9(A). A series chain of heaters each drawing 0.15 ampere in a circuit with a single voltage-dropping resistor.

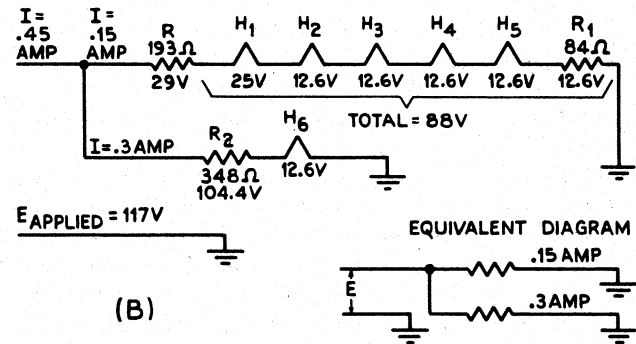

Fig. 1-9(B).  $H_6$  of Fig. 1-9(A) has been replaced by a 12.6-volt, 0.3-ampere one requiring a separate series circuit and an increase in the current drawn from the line source. Now there are two dropping resistors, one in each branch of the circuit.

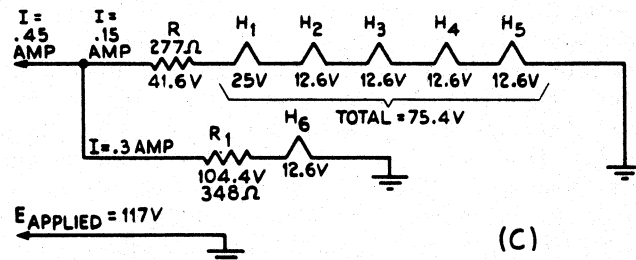

Fig. 1-9(C). Same as Fig. 1-9(B) except that the dropping resistor in the longer branch now is a combination of the dropping resistor  $R$  and the compensating resistor  $R_1$  of the previous diagram.

the original line dropping resistor remains intact. Compare Figs. 1-9(A) and (B). Since the drop across the 0.3-ampere heater is 12.6 volts and the line voltage is 117 volts, a line dropping resistor must be added to this circuit.  $R_2$  serves this purpose; its ohmic value (348 ohms) is such that it will drop 104.4 volts at 0.3 ampere.

Examination of the two series circuits of Fig. 1-9(B) shows that they are actually in parallel since each goes from the 117-volt line to ground. This is illustrated in the equivalent diagram in Fig. 1-9(B). The total resistance of each of the parallel branches is such that 0.15 ampere flows in one, whereas 0.3 ampere flows in the other.

## RECEIVING TUBE SUBSTITUTION GUIDE

The equivalent circuit in Fig. 1-9(B) is an important one to understand because it shows the application of two series circuits connected in parallel. Television receivers intended for use on a-c—d-c lines employ such circuit arrangements quite frequently, see Fig. 1-8 and the schematics at the end of Section 3.

A modification of Fig. 1-9(B) appears in (C). The substitution requirement remains the same, but this time the resistance equivalent of the heater which has been removed is not inserted. Instead, the line dropping resistor is changed in value so as to compensate for the reduced total voltage drop across the heaters. With one 12.6-volt heater removed, it has fallen to 75.4 volts from the original 88 volts. This necessitates an increase in the line resistor  $R$  from the original value of 193 ohms to 277 ohms. (This follows from the fact that the heater removed from the string had a resistance of 84 ohms, and in order to maintain the original amount of current in the circuit, this amount of resistance must be added to the line dropping resistor. The change is essentially the transposition of the resistor  $R_i$  in Fig. 1-9(B) from its position at the grounded end of the string to the line dropping resistor.) Now the drop across the line dropping resistor is 41.6 volts, or the original 29.6 volts plus the 12.6 volts representing the displaced heater. The second series leg of the circuit is the same as shown in Fig. 1-9(B), because its demands have not been changed in any way by the modifications applied to the other series circuit.

Several other interesting details may be mentioned about the arrangements in Figs. 1-9(B) and (C). In the latter, the increase in the value of the line dropping resistor means an increase in power dissipation. The power dissipation in the resistor in (B) is 4.34 watts; the power dissipation in the resistor in (C) is 6.23 watts. However, it is necessary to add to the former the amount dissipated in the resistor  $R_1$  which has replaced the heater. This power is 1.89 watts, which when added to the 4.34 watts, totals the same amount as is dissipated in the higher value of resistance used in Fig. 1-9(C). At first glance there may appear to be no difference between the two systems, yet there is a substantial difference. It is simply that two resistors, one of 4.34 watts and another of 1.89 watts rating (or whatever may be the wattage ratings selected to afford ample safety factor), are definitely more expensive than a single resistor of such wattage rating as will satisfy a power dissipation of 6.23 watts.

For purposes of comparison let us identify the power dissipation in the system shown in Fig. 1-9(C). The power dissipation in the 150-ma leg is 11.34 watts in the heaters and 6.18 watts in the line dropping resistor  $R$ , a total of 17.49 watts. The power dissipated in the 300-ma circuit is 3.78 watts in the heater and 31.32 watts in the line dropping resistor  $R_1$ , making a branch total of 35.10 watts. The dissipation in both circuits is the sum of the branch wattages or 52.59 watts.

A third possible arrangement for the substitution is shown in Fig. 1-9(D). In a way, this is a more practical way to connect a 12.6-volt, 0.3-ampere heater in place of a 0.15-ampere heater of like voltage rating. Only one series string is arranged, although it contains two parallel circuits. This system operates in a similar manner to that shown in Fig. 1-8. Of course, the ability to assemble such a circuit depends upon the number of heater elements present. The four heaters  $H_2, H_3, H_4,$  and  $H_5$  are of like constants, therefore, two series pairs connected in parallel result in a system requiring 25.2 volts and 0.3 ampere. In order that heater  $H_1$  draw only 150 ma, it is shunted with a resistance equal to its own resistance. Thus, the original six tubes now are arranged so that they can be assembled into a single series string and supplied with 0.3 ampere of current.

The rearrangement of the 150-ma tubes reduces the total voltage drop across the heaters because the paralleled pair of series heaters draws only 25.2 volts compared to its former 50.4 volts. The result is that the total drop across the heaters is reduced to 62.8 volts. This requires a change in the line dropping resistor to that ohmic value (181 ohms) which will draw 54.2 volts and so drop 117 volts to the 62.8 volts at 0.3 ampere required by the heaters. Relative to the power consumption in such a system, the four series-parallel

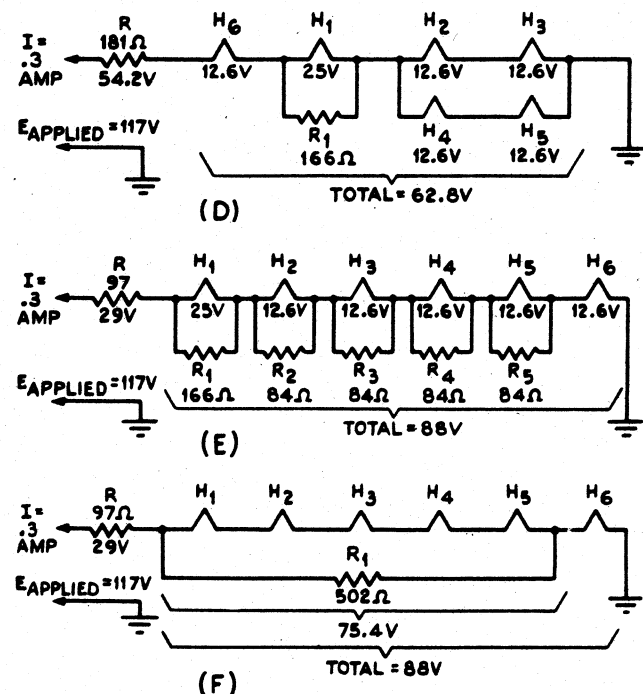
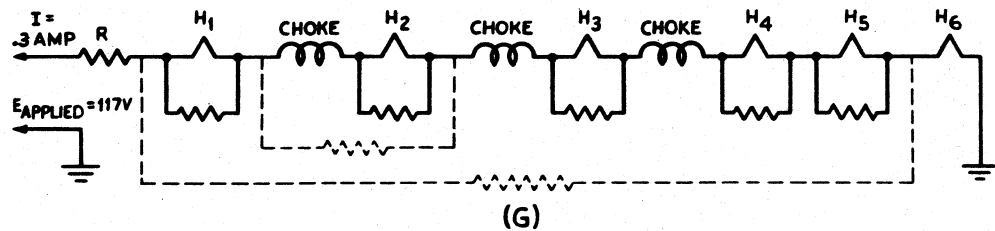

Fig. 1-9(D), (E), and (F). Various methods are shown here for shunting the heaters of the circuit shown in Fig. 1-9(A), after the substitution of a 12.6-volt 0.3-ampere heater for  $H_6$ , so that the voltage and current requirements of each heater are satisfied.

## RECEIVING TUBE SUBSTITUTION GUIDE

Fig. 1-9 (G). Part of a television receiver filament circuit showing the isolating chokes used between the heaters in the series chain. The shunts shown in dotted lines are unacceptable because they nullify the action of the chokes.



heaters dissipate 1.89 watts each for a total of 7.56 watts; the 25-volt heater  $H_1$  with its shunt consumes 7.5 watts; the 12.6-volt 300-ma heater  $H_6$  consumes 3.78 watts; and the line dropping resistor consumes 16.26 watts. The total power dissipation of the whole circuit is, therefore, 35.1 watts. A comparison between the total power consumption of the circuit in Fig. 1-9(D) and that in Fig. 1-9(C) illustrates the economy in power consumption possible by a choice of circuits.

A modification of the circuit in Fig. 1-9(D), designed to allow the replacement of a 150-ma heater tube with a 300-ma one, is shown in Fig. 1-9(E). Here, all the heaters are in a single chain with a current shunt across each 150-ma tube; the 300-ma heater  $H_6$  does not require a shunt. The ohmic value of these shunts is equal to the resistance of each of the shunted heaters. The power consumption of the entire system totals 36 watts made up as follows: each of the shunted 12.6-volt heaters with its shunt consumes 3.8 watts, the unshunted 0.3-ampere tube requires approximately the same amount of power, the 25-volt shunted heater with its shunt consumes 7.5 watts, and the line dropping resistor consumes 8.7 watts, a total of 35.2 watts. This is slightly more than the consumption of the circuit of Fig. 1-9(D), but it is much less than that required by circuit 1-9(C). As to the relative ease of installation of circuits 1-9(D) or (E), it is a matter of specific circumstances, there being little to choose in terms of power saving.

The reduction of the line voltage-dropping resistor  $R$ , in Fig. 1-9(E) is significant. It means a smaller unit and one with lower power dissipation rating, making it more convenient to install than larger units.

A simplification of the shunted heaters is shown in Fig. 1-9(F). Instead of individual current shunts, a single shunt  $R_1$  of suitable value (equal to the combined resistance of the shunted heaters) is connected across the 150-ma heaters,  $H_1$  to  $H_5$ . As indicated in the diagram, this resistance amounts to 502 ohms, which is the aggregate of four heaters of 84 ohms each, and one heater of 166 ohms. The 300-ma heater  $H_6$  requires no shunt, therefore, it is not included by the common shunt  $R_1$ .

The use of a common shunt across several tube heaters is not generally applicable to television receivers without taking special precautions. The reason for this is that it is common practice in series-wired television

receivers to isolate one heater from the other by means of isolating chokes [see Fig. 1-9(G)]. These are part of the filament circuit, but their d-c resistance is extremely low. Any attempt to shunt current around these heaters must exclude the choke from the shunted circuit otherwise the effectiveness of the choke will be materially reduced, if not completely nullified. This means that the current shunts shown in dotted lines in Fig. 1-9(G) are undesirable, instead, each tube should be shunted separately and care must be exercised to see that the shunt is connected directly across the terminals of the related heater and does not include the associated choke.

### Series-Parallel Circuits

Having described the parallel and the series systems separately, the organization of the series-parallel system should pose no problem. It is doubtful that the occasion will arise which requires the design of a complete new heater system, usually, the substitution involves one or two tubes at the most and these can be treated as illustrated in Figs. 1-9(B) through (G). An example of a series-parallel combination somewhat more complex than the usual is illustrated in Fig. 1-10. To simplify the treatment of this circuit, we will divide the heaters into two strings, and examine each separately.

In string 1, heaters  $H_1$  and  $H_6$  require heater current equal to the total line current entering the string. Heaters  $H_2$  through  $H_7$  are alike in their requirements for they draw the same current and voltage, however, the total current drawn by these heaters is less than  $I_1$  because of the presence of the current shunt  $R_1$ . Furthermore, we note a number of voltage drops in string 1 indicated by the letter  $E$  with subscripts. Voltage drop  $E_i$  appears across the extreme limits of the string and is equal to  $E$ , the line voltage. The presence of the line dropping resistor  $R$  in series with the heaters in string 1 indicates that the total voltage drop in the system  $E_{11}$  is less than the applied voltage. The latter is equal to the sum of  $E_{11}$  and  $E_{12}$ . In turn  $E_{11}$  is composed of the sum of the voltage drops  $E_a$ ,  $E_b$  and  $E_c$ .

Suppose, for the moment, that heater  $H_1$  is rated at 25 volts and 0.8 ampere, heater  $H_6$  is rated at 12.6 volts and 0.8 ampere, and heaters  $H_2$  through  $H_7$  are rated at 12.6 volts and 0.15 ampere. This identifies  $E_b$



## RECEIVING TUBE SUBSTITUTION GUIDE

as being 37.8 volts, and  $E_{11}$ , therefore, amounts to  $25 + 12.6 + 37.8$  or 75.4 volts. The line dropping resistor  $R$ , therefore, disposes of 41.6 volts at 0.8 ampere. The series-parallel arrangement of heaters  $H_2$  through  $H_7$ , without the shunt  $R_1$  requires only 0.3 ampere, however, the line current is 0.8 ampere. Therefore, shunt  $R_1$  must bypass 0.5 ampere. Its value can be determined by  $R = E/I$ , where  $E$  is the voltage across the shunt, in this case  $E_b$  (37.8 volts), and  $I$  is the current to be shunted through the resistor (0.5 ampere).  $R_1$ , therefore, is equal to 75.6 ohms.

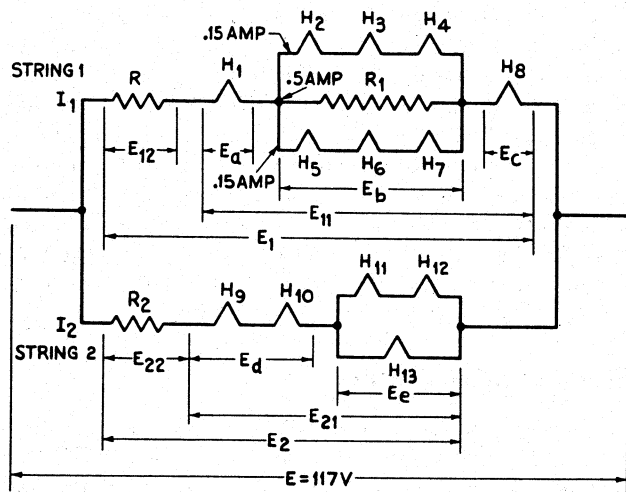

Fig. 1-10. In a series-parallel arrangement of tube heaters such as shown here, each string should be considered separately to find the requirements of each heater.

The distribution of voltages and currents in string 2 requires no special comment. What has been said so far will make the organization of this string easy to follow with the possible exception of the shunting of heater  $H_{13}$  across the series pair  $H_{11}$  and  $H_{12}$ . This is made possible by virtue of the relative voltage ratings of these three heaters; heaters  $H_{11}$  and  $H_{12}$  are rated at one-half of that of  $H_{13}$ , or the total drop across the series pair  $H_{11}$  and  $H_{12}$  equals the drop across  $H_{13}$ . The total current drawn by  $H_{11}$ ,  $H_{12}$ , and  $H_{13}$  must equal the current flowing in the line through  $H_9$  and  $H_{10}$ . Further examples of such circuits will be found in Section 3.

### Dual-Heater Voltage and Current Tubes

Some tubes contain dual heaters which are connected in series and tapped at the midpoint, offering three points for connection. They bear one voltage rating when the two heaters are used in series and another voltage rating (half the previous value) when they are connected in parallel. Naturally, the parallel connection bears a current rating which is twice that

of the series rating. Circuitwise, the heaters appear as shown in Fig. 1-11, and are listed in a tube characteristic chart as follows:

TUBE TYPE	FILAMENT VOLTAGE OR	HEATER CURRENT
3E6	1.4	0.10 ampere
	2.8	0.05
12AT7	6.3	0.3
	12.6	0.15

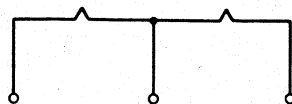

Fig. 1-11. Dual heaters such as appear in dual-heater tubes have their midpoint tapped. This makes it possible to connect the heaters either in series or in parallel with each other.

The use of such tubes in a system affords a more convenient means of substitution than the use of single rated heaters for, by simply arranging the heaters in parallel, they can be made to serve in circuits which require the lower of the two voltages and the higher of the two current ratings. By using the tube with series-connected heaters, it will suit the needs of circuits which require the higher voltage rating and the lower current rating.

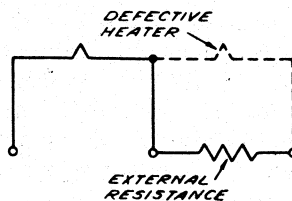

Fig. 1-12. A defective heater in a dual-heater tube may be replaced by an external resistor equal in resistance to the defective element.

Each of these dual heaters is a resistance and, when the heaters are used in parallel, the resultant resistance is half that of either. When they are used in series, the total resistance is equal to twice that of either. In the event of failure of either heater, the remaining heater is capable of causing sufficient electron emission from the cathode and the tube may be treated as if it had but one heater. If it is a matter of maintaining a certain voltage drop in a heater system, the defective heater may be replaced by an external resistance equal in value to that of the original heater. This is illustrated in Fig. 1-12. It must, of course, be understood that when this external resistance replaces the bad heater it will contribute nothing to the emission.

### Resistor Substitution

A number of factors control the substitution of resistors, these are:



## RECEIVING TUBE SUBSTITUTION GUIDE

- a. Type (wire or processed)
- b. Ohmic value
- c. Tolerance
- d. Wattage rating.

Relative to the type, wire-wound resistors should not be used in frequency-sensitive circuits unless so stated. The reason for this is the winding has inductance and distributed capacitance. If a resonant peaking circuit contains a carbon resistor in series with the peaking coil, replacing that resistor with a wire-wound unit will change the frequency of resonance, and so alter the operation of the device. Such conditions will be found in wideband amplifiers. In general, therefore, replacement resistors should be of the *same type* as those which were removed. Carbon resistors are preferable in all high-frequency circuits, unless otherwise indicated. In circuits which are not frequency sensitive, the replacement of a processed resistor by a wire-wound one is satisfactory, except when wire resistors appear in both grid and plate circuits of the same tube. This may result in feedback and oscillation in amplifier circuits which handle reasonable amounts of power. Resonance may be created by means of the related distributed capacitance and the inductance of the resistor.

Concerning the ohmic value, it is assumed that the correct substitution will be made with whatever tolerance is indicated in the reference information that describes the constants of the circuit where the replacement is being made. Data concerning tolerance identifications on processed resistors will be found in Section 5.

Sometimes, a single resistor must be replaced by two resistors or a shunt must be added so as to change the ohmic value of a portion of the circuit in order to satisfy the requirements of a tube substitution. The equivalence between a single resistor and other combinations which can produce the same value is shown in Fig. 1-13.

When resistances are in series, the total resistance is equal to the sum of the individual resistances, no matter how many there are [Fig. 1-13(A)]. The re-

sultant resistance of two resistances in parallel is equal to the product divided by the sum, see Fig. 1-13. The number of resistances which may be placed in parallel is limited by practical considerations. If more than two must be shunted in order to arrive at a certain resultant, the following equation should be used

$$\frac{1}{R} = \frac{1}{R_5} + \frac{1}{R_6} + \frac{1}{R_7} + \dots \text{ [see Fig. 1-13(C)].}$$

For the case of three parallel resistors, the resultant reduces to the fraction shown in Fig. 1-13(C).

Sometimes the situation demands that a certain resistance be shunted by another to produce a certain final value. The ohmic value of the shunt is determined as follows

$$R_{\text{shunt}} = \frac{\text{desired resistance} \times \text{original resistance}}{\text{original resistance} - \text{desired resistance.}}$$

For example, a 100,000-ohm load resistance must be reduced to 30,000 ohms in order to suit the new tube used. What shall be the ohmic value of the shunt required for this job? Using the equation given above

$$\begin{aligned} R_{\text{shunt}} &= \frac{30,000 \times 100,000}{100,000 - 30,000} = \frac{3,000,000,000}{70,000} \\ &= 43,000 \text{ ohms (approx.).} \end{aligned}$$

Tolerance ratings, expressed in percentage, are the amounts by which a rated resistance may differ from the actual resistance of the element. A plus tolerance means that the actual value may be higher than the rated value by some amount not exceeding the tolerance figure; a minus tolerance means that the actual value may be lower than the rated value by some amount not exceeding the tolerance. Thus, a 1-megohm resistor rated at + 5 per cent means that it may be as high as 1,050,000 ohms; if the tolerance was - 5 per cent, its value might be as low as 950,000 ohms. Combining a plus tolerance resistor with a minus one is a good way of arriving at a desired resultant when two of like value are not available. There are many resistors that have a plus and minus tolerance rating. Thus, a 1,000-ohm resistor of  $\pm 10$  per cent may be as high as 1,100 ohms, or as low as 900 ohms.

The power dissipation in a resistor carrying current may be expressed by any one of the following methods

$$P = I^2R = \frac{E^2}{R} = EI$$

where  $I$  is the current flowing through the resistor;  $R$  is its ohmic value, and  $E$  is the voltage drop across the resistor. In most cases, the wattage rating of a resistor is an important factor. In certain grid circuits, however, where the current is so small as to be negligible, the resistor's power dissipation value is not important. A half-watt rating will be found suitable for all such circuits. However, in those instances when

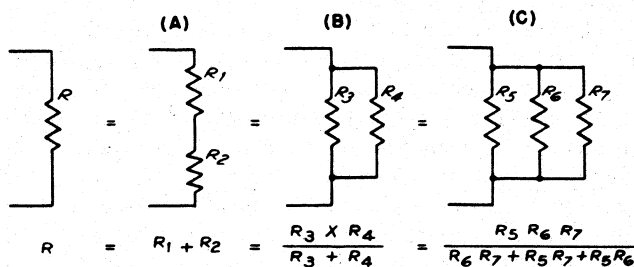

Fig. 1-13. The use of a combination of resistors to produce the same total resistance as a single one is shown in (A), (B), and (C). The total resistance of each of the combinations may be found from the formula beneath it and is equal to the single resistance  $R$  shown at the left.

## RECEIVING TUBE SUBSTITUTION GUIDE

grid current exists and is used to develop all or part of the grid bias, the wattage rating must be based upon the calculated power dissipation. In general, a maximum safety factor of 100 per cent should be allowed above the calculated value. This means that the wattage rating of the resistor chosen should be equal to twice the calculated power dissipation. Such a factor of safety is more than ample. For example, if the dissipation is 1.2 watts, use a 2-watt resistor; if it is 3 watts, use a 5-watt resistor; if it is 6 watts, use a 10-watt resistor; and if it is 13 watts, use a 20-watt resistor. Note that the required wattage is slightly less than double the calculated value in each case. Thus we see why a 100-per cent factor of safety is considered a maximum.

A consideration of moment is the possible tube damage resulting when a resistor burns out. If damage can result due to an excessive rise in plate current or voltage, in the event that a resistor burns out, it is advisable to use a resistor which has a higher wattage rating than the one being replaced.

If the occasion arises to replace a resistor in one leg of a balanced circuit, for example, in the plate or grid circuit of a push-pull stage, it may be necessary to replace the resistor in the other leg also so as not to disturb the balanced condition of the circuit elements. When a replacement is made in such a case, both resistors should have not only similar ohmic values, but should be of similar construction and have similar tolerances and wattage ratings as well.

### Fixed Capacitor Substitution

The cardinal factors associated with fixed capacitors are the capacitance, d-c working voltage, and leakage resistance. The requirements relative to capacitor values are so obvious as to require no discussion other than to mention the equivalence between several arrangements, as shown in Fig. 1-14. Two like-value capacitors in series produce a resultant which is equal to one-half the capacitance of either one. Two or more unlike capacitors in series are treated the same as resistors in parallel. Capacitors in parallel are additive.

The d-c working voltage corresponds to the peak a-c voltage which may be applied to the capacitor. Practically speaking, d-c working voltage ratings are somewhat lower than can actually be applied to the capacitor

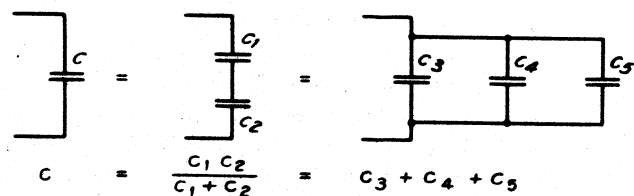

Fig. 14. Combinations of capacitors which give resultant capacitances equal to that of a single capacitor are shown here with the resultant capacitance of each combination listed below it.

because of the safety factor, but common sense dictates that operations should be carried on within the limits set by the rated working voltage. In view of this situation, care must be exercised against interpreting the d-c working voltage as being the equivalent of the rms or effective value of a-c voltage; if this is done, the probability exists that the peak a-c voltage in the circuit will puncture the capacitor. The correspondence between these different values of voltage is as follows

$$\text{D-C Working Voltage} = \text{Peak A-C Voltage} = 1.414 \times \text{RMS Voltage.}$$

If by error the rms voltage in a circuit equals the d-c working voltage rating of the capacitors, the peak a-c voltage in those circuits (exclusive of surges) will be 1.414 times higher. If any question arises concerning the rms voltage and the d-c working voltage of a capacitor in a circuit, the rms voltage which is usable may be found from the following equation

$$\text{RMS Voltage} = \text{D-C Working Voltage} \times 0.707.$$

This is an important consideration in rectifier systems and wherever both a-c and d-c voltages are involved. The input capacitors in capacitance input filter systems should have a d-c working voltage rating which is somewhat higher than the peak voltage available from the plate winding of the power transformer. This will take into account possible surges which may occur. It is well to bear in mind that repeated failure of capacitors at one point in a system is proof of an insufficient voltage safety factor in the selection of the voltage rating. This is especially true when a substituted rectifier is of the filament type, whereas tubes which receive their voltage from the rectifier are of the heater type. In such cases, high voltages will prevail in the rectifier during the time required for the load tubes to reach the conducting state.

If parallel or series capacitor combinations are used as replacement for a single capacitor, care must be taken that the d-c working voltage across each part of the combination is its rated one. For example, if two capacitors are in series the voltage across each should be inversely proportional to their capacitances and together should equal the total voltage across them. When the combination is a parallel one, the same d-c working voltage will appear across each capacitor.

The d-c leakage in fixed capacitors is an important item in connection with substitution. For example, capacitors which are intended to isolate one point from another relative to d.c. should have low leakage, which means high insulation resistance. High leakage in coupling capacitors can very materially influence the bias on the grid of the tube connected to the resistor and adversely affect the performance of that tube. In this connection, electrolytic capacitors have the highest leakage, paper dielectric capacitors are lower, and mica or ceramic capacitors have the lowest leakage. Vacuum capacitors are, of course, ideal but their use is limited mostly to high-voltage points in transmitters and similar equipment.

## RECEIVING TUBE SUBSTITUTION GUIDE

When working in high-frequency circuits, the substitution should, if at all possible, be a duplicate of the capacitor being replaced, which in many cases will be a ceramic capacitor. If it is not available, then a mica is the next best choice.

As a means of conserving space, some ceramic capacitors are dual units, that is, the same housing includes a resistor (possibly more than one) which is associated with the operation of the device. Sometimes two such capacitors and a resistor, forming a complete load assembly, may be in one unit. These should be replaced as a unit, but in an emergency, a substitute may be used for only that part of the assembly which has failed. Note: an examination of a circuit may disclose more components than are present physically; some of these "missing" elements may be included in dual units.

### I-F Transformer Substitution

The replacement of i-f transformers is determined by circuit location and circuit constants. The location determines whether it falls within the category of an "input," "interstage," or an "output" transformer. These identifications are found in service notes and parts catalogs. With the exception of receivers which contain only a single stage of i-f amplification, all superheterodynes make use of the aforementioned three general types of transformers. The input and interstage kinds may be interchangeable but the output transformer, which feeds a diode demodulator, is of a special design. Therefore, when it is necessary to replace the i-f transformer which feeds the signal to the diode demodulator, every effort should be made to secure a replacement which has been designed to perform that function.

Substantial differences may be found in the numerous varieties of i-f transformers which are employed by receiver manufacturers. Replacement of identical units is possible only by procuring the part from facilities related to the original receiver manufacturer. However, general replacement i-f transformers are suitable substitutes if the proper precautions are exercised when the substitution is made. For example, some i-f transformers used in combination a-m—f-m receivers are of the dual-frequency variety, that is, two different transformers contained in the same can. In other cases, trimmers, or filter elements related to the stage are contained in the same can with the transformers. Examples of these two are shown in Figs. 1-15(A) and (B).

The replacement of such devices by substitutes involves consideration of all of the factors involved. Two individual i-f transformers, an a-m and a separate f-m unit, may be connected externally to form the equivalent of the original shown in Fig. 1-15(A). However, if the original contains additional elements

such as resistors and filter capacitors, these must be added in the substitution. The same is true of the replacements for either a-m or f-m transformers which contain special elements. We are referring particularly to units in which the trimmer capacitor is a combination element, part of it being used in the grid filter system of that stage. This may not become evident in a casual inspection of the device or the schematic, for the symbols representing the filter resistors and capacitors are not necessarily shown as a part of the trimmer. This calls for a careful examination of the transformer and the filter circuits. If the transformer is removed and with it all of the filter elements, then a substitution must consist of a corresponding number of units.

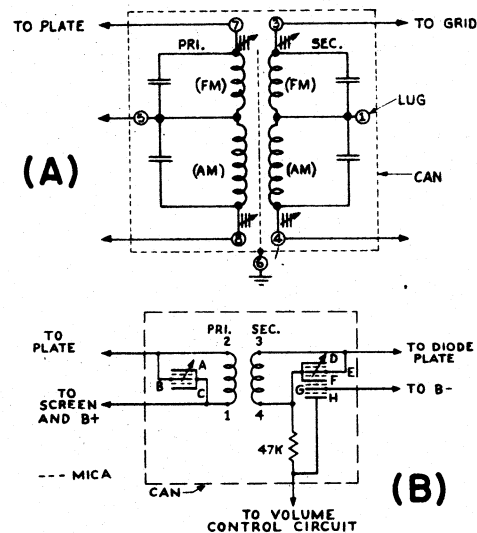

Fig. 1-15. (A) An i-f transformer of the dual-frequency variety found in a-m—f-m receivers. The a-m and f-m windings of the i-f transformer are in series and are contained in the same can; in (B) is shown a unit which contains, besides the i-f transformer, the filter capacitors and trimmers used in the associated circuit.

Relative to the general requirements of i-f transformers, those designed for use with pentodes will serve with any pentode or tetrode. The specific electrical characteristics of all pentode or tetrode i-f amplifiers are not alike, but the differences in i-f transformer performance due to this variable will not be significant if all other requirements are satisfied.

The intermediate frequency is another controlling factor in the selection of a substitute i-f transformer. Several broad categories exist, those used in a-m receivers, those in f-m receivers, and those in television receivers. In each group, the bandwidth requirement is pertinent to the selection of the replacement as is the specific intermediate frequency. Reference to the service data on the receiver is essential; the intermediate frequency used in a receiver does not dis-

## RECEIVING TUBE SUBSTITUTION GUIDE

close the specific bandwidth conditions in the i-f transformers. In some cases, all transformers are relatively broadband, being closely coupled. In other instances, the over-all broadbanding is accomplished by staggering the i-f peaks in the individual stages.

Concerning the center frequency, i-f transformers intended for a-m receivers have been standardized to four center frequencies, 130 kc, 175 kc, 262 kc, and 455 kc. From this point on, different types produced by different manufacturers afford different over-all frequency coverage. These vary from a low of about 5 per cent to a high of 40 per cent of the center frequency. For example, one manufacturer may produce an i-f transformer with a center frequency of 455 kc and an over-all tuning range of 50 kc, which is the equivalent of 25 kc each side of the rated center frequency. Some other manufacturer may design his transformers so that the over-all tuning range may be 200 kc, equal to about 40 per cent of the center frequency.

As a rule, the higher the center frequency, the wider is the over-all tuning range, but all makes of i-f transformers of like center frequency do not afford like frequency coverage. In other words, the selection of a transformer demands recognition of the bandwidth requirements of the stage wherein it is to be used. Attention must also be paid to the tuning range of a unit if the intermediate frequency in the receiver is not the same as the center frequency of the transformer.

Concerning dual i-f transformers (a-m and f-m), the generally standardized frequencies found in the i-f systems of such receivers preclude any problems other than the one we referred to earlier, that is, to be certain that all of the filter components which exist inside of the original receiver manufacturer's unit appear in the receiver after the replacement has been made.

Up to this point we have neglected the factor of space relative to i-f transformer substitution. It can well be a problem. If the substitution is a transformer for a transformer, that is, single band for single band, it is not too difficult even if the substitute is larger than the original (which seldom is the case). If a dual band (single can) transformer must be replaced by two individual transformers, however, we have a problem. It is possible to find i-f transformers which are smaller than the usual variety. It takes effort to select the ones needed because several factors must be taken into account, but it can be done.

### Power-Transformer Substitutions

The physical size and the electrical ratings are two dominant factors in such substitutions. The limitations caused by size are so obvious as to require no elaboration. Concerning electrical ratings, the first essential is that the transformer afford the same over-all capabili-

ties as the original, that is, its windings should be equal in number to that of the original so as to duplicate the functions of the original. This statement is subject to some slight qualifications which will appear when we discuss the filament windings, but in general, it can be said that the maximum convenience in substitution is attained if the substitute has at least as many different windings of like electrical rating as the original.

So far as physical characteristics are concerned, if the original transformer is shielded completely, the substitution unit should be likewise. If the original employs vertical shield mounting, so should the substitute; if the original has horizontal shield mounting, the replacement should duplicate it. Such attention to shielding will result in freedom from field troubles. Open-core transformers can cause trouble if located close to grid and plate wiring. If they must be used because the exact replacement is not available, the possibility of hum troubles must be recognized.

Each winding bears a voltage and a current rating with supplementary identification concerning the center tap. Although a center tap can be arranged by means of a center-tapped resistor connected across an untapped winding, it is preferable if the tap is a part of the winding. A suitable value for a resistor to be used for a center tap is 100 ohms.

*Increasing Heater Voltage Rating.* Although it is best if the filament windings on the transformer are the same in number and rating as the original, it is very possible that such replacements will not be available. In that event, the following information will be useful. Filament windings when connected in series furnishes a resultant voltage which is the sum of the voltage ratings of the individual windings. A 2.5-volt winding in series with another of 5.0 volts will be the equivalent of a voltage source rated at 7.5 volts. Care must be exercised to see that the two windings are connected with the windings aiding each other. An a-c voltmeter connected across the combined windings will indicate if they are aiding or bucking. The current rating of a series winding of this kind is limited to the lower of the two ratings of the individual windings.

For example, if two 6.3-volt windings, each rated at 1.2 amperes are connected in series aiding, the voltage rating of the two windings is 12.6 volts at 1.2 amperes. If one of these is rated at 0.9 ampere and the other at 1.5 amperes, the current output of the series winding would be limited to 0.9 ampere.

*Increasing Heater Current Rating.* Windings may be connected in parallel so as to increase the current output rating, provided that each of the windings connected in parallel is rated at the *same* value of voltage. The current ratings need not be the same; the total current output will be the sum of the two individual current ratings. Care must be exercised to see that the two windings are connected in proper phase, otherwise they will buck each other. An a-c voltmeter connected across one winding while the other is being connected

## RECEIVING TUBE SUBSTITUTION GUIDE

in parallel will show whether the phase is correct. If the voltage is reduced, they are bucking.

Relative to the center-tap connection, if two like voltage windings are connected in series, the junction between them can serve as the center tap; individual center taps on the two windings being disregarded. If two unlike voltage windings are connected in series, the midpoint of a 100-ohm resistor, shunted across the combined windings, can be used as the center tap.

If two windings are connected in parallel and each of them has a center tap, the two center taps may be connected together to serve as the combined center-tap connection. If only one of two windings in parallel has a center tap, it cannot be used as the center tap to serve both windings, a 100-ohm center-tapped resistor should be connected across the untapped winding and its midpoint joined to the other center tap, at which point the common connection can be made.

*Substitute Heater Windings.* If the replacement transformer does not contain all the required heater windings, a supplementary filament transformer, capable of furnishing the required voltage and current, can be used apart from the regular power transformer. Its primary should be connected in parallel with the other transformer.

Half-wave rectifier heater windings do not require center taps. Either end of the winding will serve as the positive output lead with a filament-type tube. Full-wave rectifiers should employ center-tapped heater windings even if the rectifiers are of the cathode type.

### Heater-Winding Insulation

As a rule, the voltage breakdown requirements of most heater windings which are a part of the power transformer can be satisfied by a rating of about 2,000 volts since the highest voltage in the system is far less than this amount. In cathode-ray equipment and other systems, it is possible that the cathode may be as much as 4,000 volts above ground and, since it is connected to the center tap of the heater winding, the latter is also above ground by the corresponding amount. This demands that the heater voltage winding be so insulated as to withstand this difference of potential. Sometimes (although very seldom), this requirement may be stated in the specifications. If it is not, it becomes the province of the technician to decide the voltage breakdown requirements of the heater winding.

### Rectifier Plate Windings

The conditions surrounding the selection of a substitute power transformer relative to the plate winding are varied, so much so, that it becomes necessary to examine several approaches to the subject. To begin with, the constants of a power transformer utilized in a receiver (or some other kind of equipment) may not

be fully identified in service literature; a part number always is given, and sometimes, the current and voltage ratings of the heater windings are stated on the manufacturer's schematic. If this data is not given, the number required and the current rating of each become evident when reference is made to the schematic wiring diagram of the equipment in which the substitution is to be made. It discloses the number of heater or filament chains, and the voltage and current requirements of each. Summation of these indicates the minimum current ratings of the heater windings. The constants of the plate winding, however, are generally omitted. This means that some way must be found to ascertain the requirements of the plate winding so a proper substitute can be found in the event that an exact replacement from the original equipment manufacturer is not available.

The type of rectifiers and their ratings indicates the maximum voltage and current requirements of the plate winding. Seldom, if ever, are these tubes operated very close to their maximum ratings. Therefore, by noting the limits indicated in the tube characteristic chart, and the practical voltages being applied to the tubes in the system under consideration, it is possible to arrive at the voltage and current ratings of the plate winding. Whether it should be a full-wave winding, that is, center tapped, or a half-wave winding is indicated in the schematic of the equipment and by the organization of the rectifier system as a whole. But it is conceivable that there still may arise problems in establishing the voltage rating of the plate winding in view of the conditions experienced in choke- and capacitor-input filter systems, and because of the manner in which the parts catalogs describe the capabilities of the plate windings of power transformers. Generalizing, we can state that when the input of the power-supply filter system is capacitive, the voltage rating of each half of the power-supply plate winding in a full-wave system can be as much as 10 to 15 per cent lower than the d-c voltage output of the rectifier at the prescribed value of d-c load. This stems from the fact that the input filter capacitance can be charged to approximately the peak value of the a-c voltage applied to the rectifier tubes. Some parts catalogs state the voltage and current ratings based on full-wave operation of the rectifier with capacitance input, whereas many others show the a-c voltage across each half of the plate winding at certain d-c values in terms of choke input. This is a cause of confusion; in one case, the a-c voltage between the center tap and the extremes of the plate winding is less than the d-c voltage output from the rectifier by as much as 8 to 10 per cent, whereas in the other case, the a-c voltage rating of the plate winding may be as much as 10 to 15 per cent higher than the d-c voltage output from the rectifier.

What can be used as a guide in determining the basic requirements of the plate winding? The original

## RECEIVING TUBE SUBSTITUTION GUIDE

schematic of the equipment should be the first source of information, especially when it is supplemented by a voltage chart which indicates the voltages being supplied by the power supply. If the plate-current requirements of the tubes are not shown in the voltage chart, a reasonable approximation of these current values can be developed from the tube characteristic charts contained herein. Then, allowing for a 10 per cent voltage drop in the filter system of the power supply and perhaps a loss of about 5 per cent of the total output current through the bleeder connected across the power supply, one can arrive at the total current load requirements of the system and the maximum a-c voltage required between the center tap and the extremes of the full-wave plate winding.

These data are naturally subject to variations, but the approach we have described is not too far off the path which must be followed. At least it suggests a way to gather the necessary information.

It may appear, because of the large number of commercial models, that receivers and amplifiers are distinctive in their general requirements. Such is not the case, for all fall into certain groupings and reflect certain general design considerations. It would be foolish to deny that such circuits as shown in Rider Manuals can serve as the guide for substitution requirements. So far as tube heater and signal electrode voltages and currents are concerned, there isn't much difference between the five- or six-tube table models produced by different manufacturers. Individuality appears in the number of tubes, the specific designs of the transformers, the combination of functions and the like, but these play very little part in establishing the requirements of a power supply.

### Cathode-Ray-Tube Substitutions

Cathode-ray-tube substitutions are more involved than ordinary receiving tube substitutions, if for no other reason than that the physical dimensions of the various cathode-ray tubes differ, and the replacement of one by another may require substantial physical changes in the cabinet. Nevertheless, substitutions are possible and the following are offered as suggestions. They are to be used in conjunction with the cathode-ray-tube specifications contained in this Guide Book.

1. All picture tube phosphors must be number 4. This is the last digit in the tube type number.

2. Wholly electrostatically operated picture tubes must be replaced with similar tubes. Since these are restricted in screen size, replacement for 7- and 10-inch electrostatically deflected and focused picture tubes are very limited.

3. Tubes which employ magnetic deflection and electrostatic focusing have no substitutes among either completely electrostatic or magnetic types. The reverse is, of course, also true, a combination magnetic-deflec-

### FOCUS COIL CURRENT RATINGS FOR MAGNETIC TYPE CATHODE-RAY TUBES

C-R Tube	Focus Coil Current (Ma)	C-R Tube	Focus Coil Current (Ma)	C-R Tube	Focus Coil Current (Ma)
10BP4 } 10BP4A }	132	14CP4 } 14DP4 }	115* 104	16MP4 } 16MP4A }	110
10CP4 } 10DP4 }	---	14FP4 } 15AP4 }	115* 159	16QP4 } 16RP4 }	125* 100*
10EP4 } 10FP4 }	132 115	15CP4 } 15DP4 }	133 140	16SP4 } 16SP4A }	110
10MP4 } 10MP4A }	---	16AP4 } 16AP4A }	89	16TP4 } 16UP4 }	115* 100*
12JP4 } 12KP4 }	158 140	16CP4 } 16DP4 }	110 115*	16VP4 } 16WP4 }	110* 110*
12LP4 } 12LP4A }	114	16EP4 } 16EP4A }	105	16XP4 } 16YP4 }	100* 100*
12QP4 } 12QP4A }	148	16FP4 } 16GP4 }	140 100*	17AP4 } 19AP4 }	115* 140
12RP4 } 12TP4 }	148 114	16HP4 } 16HP4A }	110	19AP4A } 19DP4 }	140
12UP4 } 12UP4A }	114	16JP4 } 16JP4A }	120	19DP4A } 19EP4 }	140*
12VP4 } 12VP4A }	---	16KP4 } 16LP4 }	97* 110	19FP4 } 19GP4 }	97-126* 107-126*
14BP4 } 14BP4A }	115	16LP4A }	110	20BP4 } 22AP4 }	122 108*
				22AP4A }	

\* Types employ RTMA Focus Coil #109, all others RTMA focus coil #106.

*Courtesy DuMont Labs*

tion and electrostatic-focusing type tube cannot be a replacement for either an electrostatically or magnetically deflected and focused picture tube. Since the 7DP4, 9AP4, 10DP4, and 12AP4 are tubes of this type, they have no replacements except each other.

4. Picture tubes differ in the focusing coil currents, consequently, in some instances the focusing coil for the substitute tube may require more current than for the original. This necessitates modification of the focusing current supply system. Conversely, some substitute tubes may require less current through the focusing coil than the original, in which case a resistor shunted across the coil will serve the purpose. This current shunt can be calculated using the d-c resistance of the focusing coil and the value of the current, just as in the case of heater current shunts. A variable resistance, 2,500-15,000 ohms, shunted across the coil can be used to determine the value for the fixed resistance shunt. The accompanying table lists the focusing-coil currents for the different magnetic-type cathode-ray tubes.

5. Replacing outside coated tubes with metal-cone types (or the reverse) requires care concerning the connection to the coating or the metal cone. The coating usually is connected to ground, whereas the metal cone usually is connected to a high voltage. The original receiver manufacturer's service notes must be consulted.

6. When a large tube is replaced by a smaller one, the characteristics of the substitute should be determined by reference to the characteristic chart; if the

## RECEIVING TUBE SUBSTITUTION GUIDE

conditions in the receiver exceed the maximum voltage ratings of the tube, these must be reduced in order to employ the substitute. Usually, those operations are too complicated for the average technician; such substitutions are not recommended.

7. All picture tubes do not utilize like tube basing. See the cathode-ray-tube basing chart in Section 5.

8. Bear in mind that the ion-trap magnets in magnetically focussed picture tubes are not all alike, some call for a single magnet, others for dual magnets; check the cathode-ray-tube characteristics in Section 5.

9. If tube characteristics indicate that the original tube has an external coating furnishing a certain

amount of capacitance and the substitute tube does not, a corresponding value of capacitance should be added to the high-voltage power supply at the high-voltage output terminal. This capacitor must have the appropriate d-c working voltage rating.

10. If the ion-trap magnet for the original tube is of the electromagnetic type (coil) and the substitute utilizes a permanent magnet, the coil unit may be left intact (placed in a recess of the cabinet), or it may be replaced by an equivalent resistance of suitable wattage rating located as closely as possible to the power supply. It should not be disconnected without substituting the equivalent resistance into the current supply circuit.

RECEIVING TUBE SUBSTITUTION GUIDE

FUNCTIONAL CLASSIFICATION OF TUBES

APPLICATION	HEATER VOLTAGES						150 MILLIAMPERE HEATER CURRENT	300 MILLIAMPERE HEATER CURRENT
	1.4	2.0	2.5	6.3	12.6			
TRIODES	26 957* 958*	1H4G 30	27 36 485††	6AD4 7A4 6C4 6A 6K4 6N4	XXL	14A4	6AD4 6C4 955 9002	7A4 37 76
DOUBLE TRIODES	3B7/1291		3B7/1291#	6AH7GT 6J6 7AF7 7F7		12AH7GT 12AT7 14AF7/XXD 14F7	12AH7GT 12AT7 14AF7/XXD 14F7	6AH7GT 7AF7 7F7 7F8
TETRODES		1A4T 1D5GT 1E5GT 32	24 35	36				36
PENTODES	1AB5** 1AD4 1ADS 1LA 1LC5 1LN5 1P5G 1P5GT 1SA6GT 1T4 1U4 1W5* 3E6 959*	1A4P 1B4P 1D5GP 1E5GP 15 34	3E6# 57 58	6AG5 6AH6 6AK5 6AU6 6BA5 6BA6 6BC5 6BD6 6BH6 6C6 6CB6 6D6 6E7 6J7 6J7G 6J7GT	6U7G 6W7G 7A7 7AB7 7AD7 7AG7 7A7 7B7 7C7 7D7 7E7 7F7 7G7 7H7 7I7 7J7 7K7 7L7 7M7 7N7 7O7 7P7 7Q7 7R7 7S7 7T7 7U7 7V7 7W7 7X7 7Y7 7Z7	12AU6 12AW6 12BA6 12BD6 12B7 12J7GT 12K7GT 12SG7 12SH7 12SH7GT 12S7 12S7GT 12SK7 12SK7GT 14A7/12B7	12SG7 12SH7 12SH7GT 12S7 12S7GT 12SK7 12SK7GT 14A7/12B7	6AU6 6BA6 6BD6 6C6 6D6 6E7 6J7 6J7GT 6J7GT 6K7 6K7G 6K7GT 6SD7GT 6SG7 6SG7GT 6SH7
TELEVISION				6AB4			6AB4	
DOUBLE TRIODES				6J6 6AB7 6AC7 6AG5	12AT7	12AT7 19J6#	12AT7 19J6	12AT7
PENTODES				6AB7 6AC7 6AG5	6AK5 6AU6 6BC5	6BH6 12AU6	6BH6 12AU6	6AG5 6AU6 6BC5 6CB6

\* 1.25 V. \*\* 1.2 V. †† 3.0 V. # 2.8 V. ## 18.9 V.

Courtesy TUNG-SOL Lamp Works, Inc.



RECEIVING TUBE SUBSTITUTION GUIDE

FUNCTIONAL CLASSIFICATION OF TUBES

APPLICATION	HEATER VOLTAGES						150 MILLIAMPERE HEATER CURRENT	300 MILLIAMPERE HEATER CURRENT	
	1.4	2.0	2.5	5.0	6.3	12.6			
TRIODES	1C3 1E4C 1C4GT 1LE3 26	1H4G 30	27 56 485††	01A	6A5GT 6AD5G 6AF5G 6C5 6C5GT 6L5G 6F5 6F5GT 6SF5 6SF5GT	7A4 7B4 37 56 75S 76	12E5GT 12F5GT 12J5GT 12SF5 12SF5GT 14A4	6A5GT 6AF5G 6AD5C 6C5 6C5GT 6F5 6F5GT 6SF5	6SF5GT 7A4 7B4 37 56 75S 76
	DOUBLE TRIODES		53		6A6 6A6GT 6C8G 6F8G 6N7 6N7G 6C7 6C7GT	12A7GT 6SN7GT 6Y7G 6Z7G 7AF7 7F7 12A7 12AX7 12AY7 79	14F7	6C8G 6C7 6SL7GT 6Z7G 12A7 12AX7	12AY7 12AX7 12AY7 12SC7 12SL7GT 14AF7 14F7
TETRODES		32	24	36				36	
PENTODES	1LA 1LG5 1U4 959*	1B4P 1ESCP 15	57		6A6 6BA5 6BH6 6C6 6J7 6J7GT 6R6G 6SC7GT	7E5 7C7 7L7 7T7 7V7 7W7 77 717A 954 956 9001 9003	12A6 12J7GT 12SH7 12SH7GT 12S7GT 14C7 14V7	6A6 6C6 6J7 6J7GT 6R6G 6SC7GT 6SH7GT 6SJ7 6SJ7GT	7L7 7T7 7W7 77
	TUNING INDICATORS		2E5 2C5		6AB5/6N5 6AD6G 6AF6G 6AL7GT 6E5 6C5 6T5 6U5/6G5 6AE6G		6AL7GT	6E5 6C5 6T5 6U5/6G5	
INDICATOR CONTROL								6AE6G	

†† 3.0 V. • 1.25 V.

Courtesy TUNG-SOL Lamp Works, Inc.

RECEIVING TUBE SUBSTITUTION GUIDE

FUNCTIONAL CLASSIFICATION OF TUBES

APPLICATION	HEATER VOLTAGES										300 MILLI-AMPERE HEATER CURRENT	150 MILLI-AMPERE HEATER CURRENT		
	1.4	2.0	2.5	5.0	6.3	12.6	18.9	25	35	50				
	GENERAL PURPOSE													
TRIODES		1H4G 30 31	2A3 45	01A 12A 71A 183	6A3 6A5G 6AC5GT 6B4G 6C4	501		25AC3GT					25AC3GT	
DOUBLE TRIODES	1G6GT 3C6/XXB	1J6G 19	53 3C6/ XXB#		6A6 6AS7G 6E6 6N7 6N7GT	6Y7G 6Z7G 79							6Z7G	
TETRODES		49	46		6AL6G									
PENTODES	1A5GT 3LE4 1A6S 3LF4 1C5GT 3V4 1L4A 3C5GT 1LB4 3Q4 1S4 3S4 1V5* 1W4 3A4 3D6	1F4 1F5G 1J5G 33 950	2A5 3A4# 3C5GT# 3LE4# 3Q4 3S4# 3V4# 47 59	257	6A4/LA 6AG/7 6AK6 6AN5 6AR3 6F6 6F6G 6F6GT 6G6G 6K6GT	6R6G 7B5 38 41 42 89		25A6 25A6GT 43			6AK6 6G6G		6A4/LA 12A5 25A6 25A6GT 25B6G 43	
BEAM PENTODES	1Q5G 1Q5GT 1T9GT 3B5GT 3LF4 3Q5GT		3B5GT# 3LF4# 3Q5GT#		6AHS 6AQ5 6AR6 6AS5 6L6 6L6G 6L6GA 6U6GT	6V5GT 6V6 6V6GT 6W6GT 6Y6 7A5 7C5		25C6G 25L6 25L6GT	35L6GT 35A5 35B5 35C5		12A6 12A6GT 14A5 14C5 1625		12A6 12A6GT 14A5 14C5 1625 35C6GT 50A5 50B5 50C5 50C6G 50L6GT	25C6G 25L6 25L6GT
DOUBLE PENTODES		1E7G			6AB6C 6AC6GT 6B6G								12L8GT	
DIRECT COUPLED													25B5 25N6GT	25B5 25N6G
BEAM PENTODES					6AU5GT 6BQ6GT 6AV5GT 6CD6G 6BC6G								19BG6G 25BQ6GT	19BG6G 25BQ6GT
TRIODES OR TRIODE CONNECTED PENTODES					6AR5 6K6GT 6S4 6SN7GT 6W6GT 12AU7								12AU7 12SN7GT	12AU7 12SN7GT

• 1.25 V. # 2.8 V. † 7.5 V.

Courtesy TUNG-SOL Lamp Works, Inc.





RECEIVING TUBE SUBSTITUTION GUIDE

FUNCTIONAL CLASSIFICATION OF TUBES

APPLICATION	HEATER VOLTAGES								150 MILLIAMPERE HEATER CURRENT	300 MILLIAMPERE HEATER CURRENT
	COLD CATHODE	1.4	2.5	5.0	6.3	12.6	25			
RECTIFIERS TELEVISION - HIGH VACUUM	DIODES	1B3GT 1X2 1Y2 1Y2 1Z2	2V3G 2X2 2X2/879 879							
	DOUBLE DIODES				6AL5	12AL5		12AL5	6AL5	
	DIODES			5V4G	6U4GT 6W4GT		25W4GT		25W4GT	
	DIODE CONNECTED				6AS7G			6AS7G		
VOLTAGE REGULATOR	DC RESTORER				6AL5	12AL5		12AL5	6AL5	
	DIODES	0Y4 0Y4G								
	DOUBLE DIODE	0Z4 0Z4G		82 83						
	GLOW DISCHARGE DIODE	0A2 0A3/VR-75 0B2 0B3/VR-90 0C3/VR-105 0D3/VR-150								
CONTROL SERVICE	GAS TRIODE	1C21	2A4G 2B4 2C4 885		6D4 6Q5G 884					
	GAS TETRODES				2D21 20S0 20S1					
	RELAY TUBE	0A5								

Courtesy TUNG-SOL Lamp Works, Inc.

## SECTION 2

### RECEIVING TUBE SUBSTITUTION GUIDE

This section includes the actual information on the tube substitutions. Four columns are included. The first column lists the tube type for which a substitute is desired. This listing is in numerical and alphabetical order. For example 6CB6 precedes 6CD6 and 6ZY5 precedes 7A4. We have not indicated any difference between metal and glass tubes of the octal type. The tube listed can thus be considered either as metal or a glass type. The letters *G*, *GT*, *GT/G*, *GA*, or *GP* indicates that the tube has a glass envelope, the *GT* and *GT/G* are smaller and newer versions of the *G* type. The glass tubes, in practically all cases, have the same characteristics as the metal types.

One of the primary differences between the glass and metal tubes is that the metal type usually have an internal shield. A pin at the base of these tubes is connected to this shield. In most cases this pin is wired to the common ground or B minus of the set. In a few cases substituting a glass type for a metal type causes the circuit to become unbalanced or feedback occurs due to a lack of proper shielding. Most often this can be overcome by shielding the tube or realigning the set.

The second column lists the various possible substitutes. Quite often more than one substitute is listed for a single tube. In such cases the tube in the first column is not repeated for each substitute but is listed only once.

The third column lists the performance of each tube. Three performance ratings are shown in this list. These are *E* for EXCELLENT, *G* for GOOD, and *P* for POOR. They define the suitability of a substitute predicated upon its electrical characteristics as compared to those of the original and upon the relationship between the characteristics of the substitute to the constants of the circuit, which was designed to function best with the original. The comparison between the characteristics of the tubes excludes the filament or heater voltage and current ratings. It is assumed that whatever may be the performance characteristics of the substitute — the filament or heater voltages and current are correct, even if it requires certain minor circuit modifications to accomplish this condition.

Concerning the *E*, *G*, and *P* ratings, it stands to reason that those tubes which bear *E* (excellent) ratings are either the exact equivalents differing perhaps in

basing and maybe in filament or heater voltage and current ratings — or so closely approximate the electrical characteristics of the original as to require no significant major modifications. All applicable tube substitutions which might bear an *E* rating in performance are not shown in the main listing. Some appear on the addendum pages. These represent last-minute additions as the result of information received from television receiver manufacturers and appear at the end of this section.

Concerning the *G* (good) rating, it reflects more than just moderate differences in tube characteristics between the substitute and the original that is being replaced. It still means a triode substitute for a triode original, or a pentode substitute for a pentode original, and sometimes the conversion of a pentode into a triode, but the plate (and screen) voltage demands of the substitute may be higher than that of the original — or the transconductance or amplification constant of the substitute may be less than the original — all of which means that the circuit demands incorporated in the equipment design are not being met by the substitute tube. Possibly the plate impedance of the substitute is higher or lower, reducing the originally intended over-all amplification; perhaps a slight amount of distortion is added to the signal by the substitute. Yet the substitute may be used even if it is not as good in performance as the original, for again it is a matter of continuing the operation of a device.

Those substitutions which bear *P* (poor) ratings are used only as a last resort. They represent the extremes in tube substitution when it is a matter of accomplishing a repair job of sorts, rather than none at all because more appropriate substitutes are not available. Of course, modifications can be made in the circuit design and circuit constants so as to accommodate the tube rated poor, in which case, considerable improvement may be accomplished. It must be remembered, of course, that the *P* rating — or for that matter, the *G* rating — is not a reflection upon the capabilities of the tube or the brand. It simply means that the tube, so designated in the list, was not intended for use in the type of system for which it is suggested as a substitute. With proper circuit changes, it might, as we said before, become a better performing substitute. But whether or not such design changes are warranted is a matter of individual consideration. As

## RECEIVING TUBE SUBSTITUTION GUIDE

far as circuit modification is concerned, it can be a tedious task. Much depends upon comparative reference data and background knowledge of circuits. Finally such changes are possible only if the cost is acceptable to the owner of the equipment.

The fourth or last column lists the circuit changes that are necessary to make the substitute operate properly. In many cases no change whatsoever is required, the original tube is pulled out and the substitute plugged in. Where the reference "parallel circuits only" or "series circuits only" is found, it refers only to the type of filament circuit arrangement in which the substitute tube can be used.

### Original and Substitute Sockets

The tube substitution lists contain illustrations of the original and the substitute tube sockets when the tube interchange involves a change in sockets. These are offered as a convenience in wiring. The views are the bottoms of the sockets and these correspond to the pin locations on the bottom of the respective tube bases. The bottom socket view of the original tube will always be found to the left of the change writeup and will bear the designation "ORIG." The bottom socket view of the substitute tube will always be found to the right of the change writeup and will bear the designation "SUB."

The instructions given between the two illustrations state the respective socket terminals involved in the rewiring operation. In view of the necessity for removing one socket before mounting the other, it is suggested that as each wire is disconnected from the original socket, it be labeled with a tiny tag showing the appropriate socket connection number. These correspond to the pin numbers on the tube base. Then when being rewired to the new socket, all that is required is to solder the numbered lead to the terminal on the socket as stated in the instructions.

Care must be exercised to see that the socket connections are read in accordance with the location of the key as shown on the pages. In order to attain correspondence between the socket mounted on the chassis and the instructions, one or the other should be changed in physical position so that the keys or identifying terminals are in the same relative position. Another precautionary note relates to the grid caps. In many cases capped tubes are replaced by single ended tubes, and vice-versa. The leads must be properly connected. Finally in some substitutions the pin numbers on the original and the substitute are the same, that is, 1 to 1, 2 to 2, 3 to 3 and so on. This is not standard for all the tubes, nor is it standard for all the pins even if it is true for some of them in any one substitution. In other words, the instructions should be read completely. Nothing should be taken for granted.

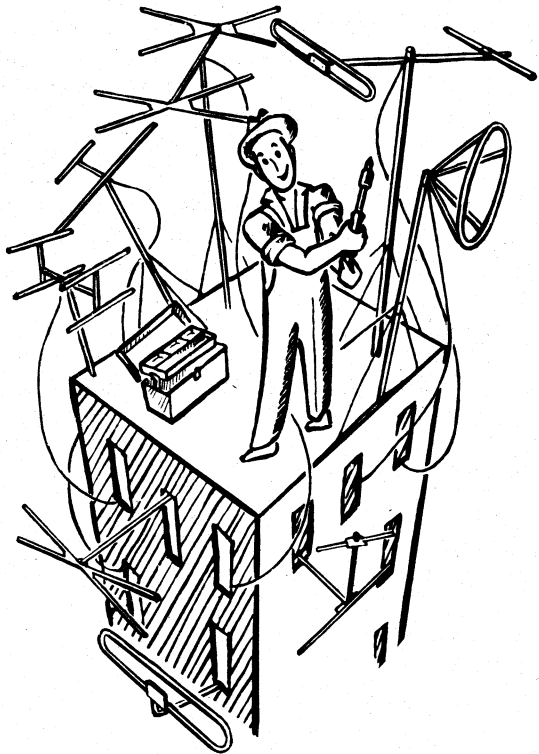

# ATTENTION! TV INSTALLERS

*Save Time and Money  
with RIDER'S New Book*

## TV Installation Techniques

By **SAMUEL L. MARSHALL**

*Television Instructor, George Westinghouse Vocational High School*

..... CONTENTS .....

Nature of Television

Radio Propagation

Basic Antenna Principles

Transmission Lines and Special Antenna Systems

Materials and Methods Used in Installations

High Mast and Tower Installations

Problems Arising in Television Installations

Receiver Adjustments and Service in the Home

Municipal Regulations

Appendix

**336 pages**

**270 illustrations**

**\$3.60**

---

---





## GET YOUR COPY NOW!

JOHN F. RIDER, PUBLISHER, Inc., 480 Canal St., New York 13, N.Y.



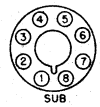



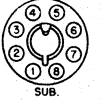

## RECEIVING TUBE SUBSTITUTION GUIDE

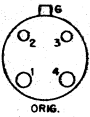
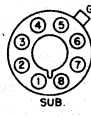
00A-1A4



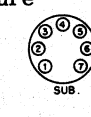

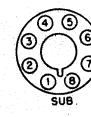
TUBE	SUB.	PERF.	CIRCUIT CHANGES NECESSARY										
00A	01A 40	E G	No changes.										
01A	00A 00AA 01B	E E E	No changes.										
0A2	0B2	P	Where application is not too critical.										
0A3	VR75	E	No changes.										
0A4	1267	E	No changes.										
0B2	0C3	E	Where space permits. Change socket to octal and rewire as follows:										
			 <table style="display: inline-table; vertical-align: middle;"> <tr> <td>No. 1 on miniature</td> <td>to No. 5 on octal</td> </tr> <tr> <td>2</td> <td>to 2</td> </tr> <tr> <td>5</td> <td>to 5</td> </tr> </table> 	No. 1 on miniature	to No. 5 on octal	2	to 2	5	to 5				
No. 1 on miniature	to No. 5 on octal												
2	to 2												
5	to 5												
0B3	VR90	E	No changes.										
0C3	VR105	E	No changes.										
	0B2	E	Reverse 0B2 to 0C3 procedure.										
0D3	VR150	E	No changes.										
0Y4	0Y4G	E	No changes.										
0Y4G	0Y4	E	Ground pin No. 1										
0Z4	0Y4 0Z4A/1003 1005/CK1005	G E E	No changes.										
	6X5	E	Solder socket terminal No. 2 to chassis. Connect 6V hot lead to No. 7. Motorolas and some other car radios have filament wired and the 6X5 may be used without making any changes.										
	7Y4	E	Change socket to loctal and rewire as follows:										
			 <table style="display: inline-table; vertical-align: middle;"> <tr> <td>No. 3 on octal</td> <td>to No. 3 on loctal</td> </tr> <tr> <td>5</td> <td>to 6</td> </tr> <tr> <td>8</td> <td>to 7</td> </tr> </table> 	No. 3 on octal	to No. 3 on loctal	5	to 6	8	to 7				
No. 3 on octal	to No. 3 on loctal												
5	to 6												
8	to 7												
			Connect No. 8 on loctal to chassis and No. 1 on loctal to 6V hot lead.										
	84	E	Reverse 84 to 6X5 procedure.										
0Z4A	0Y4 1005/CK1005	G G	No changes.										
1A3	1B4/1294	E	Where space permits. Change socket to loctal and rewire as follows:										
			 <table style="display: inline-table; vertical-align: middle;"> <tr> <td>No. 1 on miniature</td> <td>to No. 1 on loctal</td> </tr> <tr> <td>2</td> <td>to 4</td> </tr> <tr> <td>3</td> <td>to 7</td> </tr> <tr> <td>6</td> <td>to 4</td> </tr> <tr> <td>7</td> <td>to 8</td> </tr> </table> 	No. 1 on miniature	to No. 1 on loctal	2	to 4	3	to 7	6	to 4	7	to 8
No. 1 on miniature	to No. 1 on loctal												
2	to 4												
3	to 7												
6	to 4												
7	to 8												
1A4	1B4	E	No changes.										

RECEIVING TUBE SUBSTITUTION GUIDE

TUBE	SUB.	PERF.	CIRCUIT CHANGES NECESSARY
1A4	1D5	E	Change socket to octal and rewire as follows: No. 1 on four prong to No. 2 on octal 2 to 3 3 to 4 4 to 7 cap to cap
	1E5	E	
			 
	32	E	No changes.
	34	E	No changes.
1A5	1C5	G	Parallel circuits only. No changes.
	1G4	P	No changes. Emergency but works well in most cases.
	1LA4	E	Change socket to loctal and rewire as follows: No. 2 on octal to No. 1 on loctal 3 to 2 4 to 3 5 to 6 7 to 8
	1LB4	E	
			 
	1N6	P	Remove and tape up any wires anchored on No. 6.
	1Q5	G	Parallel circuits only. No changes.
	1S4	P	Same as 3Q5 to 3S4, except do not connect No. 8 on octal to No. 5 on miniature. Parallel circuits only.
	1T4	P	Emergency substitution. Tone OK at low volume. Change socket to miniature and rewire as follows: No. 2 on octal to No. 1 on miniature 3 to 2 4 to 3 5 to 6 7 to 7
			 
	1T5	G	No changes. Filament current 10 mils higher but gives satisfactory results.
	3Q4	P	Electric operation only. Same as 3Q5 to 3S4, except connect nothing to No. 5 on miniature.
	3S4	P	
	3Q5	P	No changes necessary. For electric operation only as the A battery will be too low with 1.4 more filament in the circuit.
1A6	1C6	E	No changes. For parallel operation only as the 1C6 draws 120 mils instead of 60.
	1C7	E	Parallel circuits only. Change socket to octal and rewire as follows: No. 1 on six prong to No. 2 on octal 2 to 3 3 to 6 4 to 5 5 to 4 6 to 7
			 
	1D7	E	Same as 1A6 to 1C7. Either series or parallel circuits.
1A7	1B7	E	Parallel circuits only. No changes.
	1C7	P	Parallel circuits only.



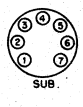

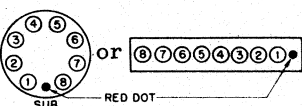
RECEIVING TUBE SUBSTITUTION GUIDE

1A7-1AD5

TUBE	SUB.	PERF.	CIRCUIT CHANGES NECESSARY														
1A7	1D7	P	No changes, unless there is a resistor across 1A7 filament, which must be removed. 1D7 is rated 2V 60 mils and draws slightly less than 50 on 1.4.														
	1L6	G	Same as 1A7 to 1U6.														
	1LA6 1LC6	E E	Change socket to loctal and rewire as follows: <table border="0" style="margin-left: 40px;"> <tr> <td>No. 2 on octal</td> <td>to No. 1 on loctal</td> </tr> <tr> <td>3</td> <td>to 2</td> </tr> <tr> <td>6</td> <td>to 3</td> </tr> <tr> <td>5</td> <td>to 4</td> </tr> <tr> <td>4</td> <td>to 5</td> </tr> <tr> <td>7</td> <td>to 8</td> </tr> <tr> <td>cap</td> <td>to 6</td> </tr> </table> <div style="display: flex; justify-content: space-around; align-items: center; margin-top: 10px;">   </div>	No. 2 on octal	to No. 1 on loctal	3	to 2	6	to 3	5	to 4	4	to 5	7	to 8	cap	to 6
No. 2 on octal	to No. 1 on loctal																
3	to 2																
6	to 3																
5	to 4																
4	to 5																
7	to 8																
cap	to 6																
	1R5	G	Make adaptor as follows: Solder rather heavy wires three inches long to all lugs except No. 5 of miniature socket. Break the 1A7, clean out the base and save the cap. Push the wires from miniature socket thru the base pins as follows: <table border="0" style="margin-left: 40px;"> <tr> <td>No. 1 on miniature</td> <td>thru No. 2 of base</td> </tr> <tr> <td>2</td> <td>thru 3</td> </tr> <tr> <td>3</td> <td>thru 6</td> </tr> <tr> <td>4</td> <td>thru 5</td> </tr> <tr> <td>7</td> <td>thru 7</td> </tr> <tr> <td>6</td> <td>bring out and solder grid cap on.</td> </tr> </table> <p>The octal socket could be replaced by a miniature using the above connections but it is usually hard to find a place to mount it.</p> <p>If 1R5 squeals, reduce value of oscillator grid resistor to 75000 ohms or less if necessary. This resistor is connected between terminal No. 5 on the the 1A7 socket and ground or filament.</p> <p>An idea we have been using successfully is to dig a trough from pin No. 5 to pin No. 7 on the adaptor, filling this with the graphite preparation made for volume controls, measuring the resistance, and filling the trough until the desired resistance is acquired.</p>	No. 1 on miniature	thru No. 2 of base	2	thru 3	3	thru 6	4	thru 5	7	thru 7	6	bring out and solder grid cap on.		
No. 1 on miniature	thru No. 2 of base																
2	thru 3																
3	thru 6																
4	thru 5																
7	thru 7																
6	bring out and solder grid cap on.																
	1U6	G	Parallel circuits only. Change socket to miniature and rewire as follows: <table border="0" style="margin-left: 40px;"> <tr> <td>No. 2 on octal</td> <td>to No. 1 on miniature</td> </tr> <tr> <td>3</td> <td>to 2</td> </tr> <tr> <td>4</td> <td>to 5</td> </tr> <tr> <td>5</td> <td>to 4</td> </tr> <tr> <td>6</td> <td>to 3</td> </tr> <tr> <td>7</td> <td>to 7</td> </tr> <tr> <td>cap</td> <td>to 6</td> </tr> </table> <div style="display: flex; justify-content: space-around; align-items: center; margin-top: 10px;">   </div>	No. 2 on octal	to No. 1 on miniature	3	to 2	4	to 5	5	to 4	6	to 3	7	to 7	cap	to 6
No. 2 on octal	to No. 1 on miniature																
3	to 2																
4	to 5																
5	to 4																
6	to 3																
7	to 7																
cap	to 6																
1AB5	1AD5	G	Parallel circuits only. Change socket to subminiature and rewire as follows: <table border="0" style="margin-left: 40px;"> <tr> <td>No. 1 on loctal</td> <td>to No. 4 on subminiature</td> </tr> <tr> <td>2</td> <td>to 7</td> </tr> <tr> <td>3</td> <td>to 8</td> </tr> <tr> <td>6</td> <td>to 2</td> </tr> <tr> <td>7</td> <td>to 5</td> </tr> <tr> <td>8</td> <td>to 5</td> </tr> </table> <div style="display: flex; justify-content: space-around; align-items: center; margin-top: 10px;">   </div>	No. 1 on loctal	to No. 4 on subminiature	2	to 7	3	to 8	6	to 2	7	to 5	8	to 5		
No. 1 on loctal	to No. 4 on subminiature																
2	to 7																
3	to 8																
6	to 2																
7	to 5																
8	to 5																
1AC5	1V5	E	No changes.														
1AD4	1AD5	G	Parallel circuits only.														
	1AE4	G	Reverse 1AE4 to 1AD4 procedure.														
1AD5	1AB5	G	Parallel circuits only. Reverse 1AB5 to 1AD5 procedure.														

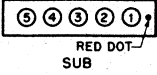
1AD5-1B7







RECEIVING TUBE SUBSTITUTION GUIDE

TUBE	SUB.	PERF.	CIRCUIT CHANGES NECESSARY
1AD5	1AD4	G	Parallel circuits only.
	1W5	E	No changes.
1AE4	1AD4	G	Change socket to subminiature and rewire as follows: No. 1 on miniature to No. 5 on 1AD4 2 to 1 3 to 2 5 to 5 6 to 4 7 to 3   Pin numbers on 1AD4 number from right to left from red mark on base, as shown.
1AF4	1AF5	P	Rewire as follows: No. 5 to No. 1 2 to 5 3 to 4 Do not use terminal No. 3 for anchor
	1L4	G	No changes. Parallel circuits only.
	1T4	G	
	1U4	G	
1AF5	1LD5	P	Parallel circuits only. Where space permits. Change socket to loctal and rewire as follows: No. 1 on miniature to No. 1 on loctal 3 to 4 4 to 3 5 to 2 6 to 6 7 to 8  
	1S5	G	Parallel circuits only. No changes.
1B3	1X2	E	Reverse 1X2 to 1B3 procedure.
1B4*	1A4	E	No changes.
	1D5	E	Same as 1A4 to 1D5.
	1E5	E	
	32	E	No changes.
	34	E	
1B5	1H6	E	Change socket to octal and rewire as follows: No. 1 on six prong to No. 2 on octal 2 to 3 3 to 4 4 to 5 5 to 6 6 to 7  
	25S	E	No changes.
1B7	1A7	E	Parallel circuits only. No changes.
	1L6	G	Parallel circuits only. Same as 1A7 to 1U6
	1LA6	E	Parallel circuits only. Same as 1A7 to 1LA6.
	1LC6	E	

\* See Addendum at back of this section.

## RECEIVING TUBE SUBSTITUTION GUIDE

1B7-1C21

TUBE	SUB.	PERF.	CIRCUIT CHANGES NECESSARY										
1B7	1R5	G	Parallel circuits only. Same as 1A7 to 1R5.										
	1U6	G	Parallel circuits only. Same as 1A7 to 1U6.										
1B8	1D8	E	No changes.										
1C3	1G4	G	Where space permits. Change socket to octal and rewire as follows: <div style="display: flex; justify-content: space-around; align-items: center;"> <div style="text-align: center;">  <p>ORIG.</p> </div> <table border="0" style="font-size: small;"> <tr> <td>No. 1 on miniature</td> <td>to No. 2 on octal</td> </tr> <tr> <td>2</td> <td>to 3</td> </tr> <tr> <td>4</td> <td>to 5</td> </tr> <tr> <td>6</td> <td>to 3</td> </tr> <tr> <td>7</td> <td>to 7</td> </tr> </table> <div style="text-align: center;">  <p>SUB.</p> </div> </div>	No. 1 on miniature	to No. 2 on octal	2	to 3	4	to 5	6	to 3	7	to 7
No. 1 on miniature	to No. 2 on octal												
2	to 3												
4	to 5												
6	to 3												
7	to 7												
	1LE3	G	Where space permits. Change socket to loctal and rewire as follows: <div style="display: flex; justify-content: space-around; align-items: center;"> <div style="text-align: center;">  <p>ORIG.</p> </div> <table border="0" style="font-size: small;"> <tr> <td>No. 1 on miniature</td> <td>to No. 1 on loctal</td> </tr> <tr> <td>2</td> <td>to 2</td> </tr> <tr> <td>4</td> <td>to 6</td> </tr> <tr> <td>6</td> <td>to 2</td> </tr> <tr> <td>7</td> <td>to 8</td> </tr> </table> <div style="text-align: center;">  <p>SUB.</p> </div> </div>	No. 1 on miniature	to No. 1 on loctal	2	to 2	4	to 6	6	to 2	7	to 8
No. 1 on miniature	to No. 1 on loctal												
2	to 2												
4	to 6												
6	to 2												
7	to 8												
1C5	1A5	G	Parallel circuits only. No changes.										
	1D8	P	Remove and tape up any wires connected to 6 and 8. No connection to top cap.										
	1LA4	G	Same as 1A5 to 1LA4. Parallel circuits only.										
	1LB4	G											
	1Q5	G	No changes. Bias different but tone is reasonably good.										
	1S4	G	Same as 3Q5 to 3S4, but connect nothing to No. 5 on miniature.										
	1T5	G	Parallel circuits no changes. Series circuits shunt 35 ohm resistor across filament.										
	3Q4	P	Change socket to miniature and rewire as follows:										
	3S4	P	<div style="display: flex; justify-content: space-around; align-items: center;"> <div style="text-align: center;">  <p>ORIG.</p> </div> <table border="0" style="font-size: small;"> <tr> <td>No. 2 on octal</td> <td>to No. 5 on miniature</td> </tr> <tr> <td>3</td> <td>to 2</td> </tr> <tr> <td>4</td> <td>to 4</td> </tr> <tr> <td>5</td> <td>to 3</td> </tr> <tr> <td>7</td> <td>to 1 and 7</td> </tr> </table> <div style="text-align: center;">  <p>SUB.</p> </div> </div>	No. 2 on octal	to No. 5 on miniature	3	to 2	4	to 4	5	to 3	7	to 1 and 7
No. 2 on octal	to No. 5 on miniature												
3	to 2												
4	to 4												
5	to 3												
7	to 1 and 7												
	3Q5	P	Same as 1Q5 to 3Q5.										
1C6	1A6	G	Parallel circuits only. No changes.										
	1C7	G	Same as 1A6 to 1C7. Either series or parallel circuits.										
	1D7	G	Same as 1A6 to 1C7. Parallel circuits only.										
1C7	1A6	G	Reverse 1A6 to 1C7 procedure. Parallel circuits only.										
	1C6	E	Reverse 1A6 to 1C7 procedure.										
	1D7	E	Parallel circuits only. No changes.										
1C8	1AE5	G	Parallel circuits only.										
	1E8	E	No changes.										
1C21			No practical substitute.										

RECEIVING TUBE SUBSTITUTION GUIDE

TUBE	SUB.	PERF.	CIRCUIT CHANGES NECESSARY
1D5	1A4	E	Change socket to four prong and rewire as follows: No. 2 on octal to No. 1 on four prong 3 to 2 4 to 3 7 to 4 cap to cap
	1B4	E	
	32	E	
	34	E	
	951	E	
	1E5	G	No changes.
1D7	1A6	G	Reverse 1A6 to 1C7 procedure.
	1C6	E	Reverse 1A6 to 1C7 procedure. Parallel circuits only.
	1C7	E	Parallel circuits only. No changes.
1D8	1B8	E	No changes.
1E4	1G4	G	No changes.
	1H4	P	
	1LE3	G	Change socket to loctal and rewire as follows: No. 2 on octal to No. 1 on loctal 3 to 2 5 to 6 7 to 8
	30	P	Change socket to four prong and rewire as follows: No. 2 on octal to No. 1 on four prong 3 to 2 5 to 3 7 to 4
1E5*	1D5	G	No changes.
	1A4	P	
	1B4	P	
	32	P	
	34	P	
	951	P	Change socket to four prong and rewire as follows: No. 2 on octal to No. 1 on four prong 3 to 2 4 to 3 cap to cap
1E7			No practical substitute.
1E8	1C8	E	No changes.
1F4	1F5	E	Change socket to octal and rewire as follows: No. 1 on five prong to No. 2 on octal 2 to 3 4 to 4 3 to 5 5 to 7
1F5	1F4	E	Reverse 1F4 to 1F5 procedure.
1F6	1F7	E	Change socket to octal and rewire as follows: No. 1 on six prong to No. 2 on octal 2 to 3 3 to 6 4 to 4 5 to 5 6 to 7 cap to cap

\* See Addendum at back of this section.





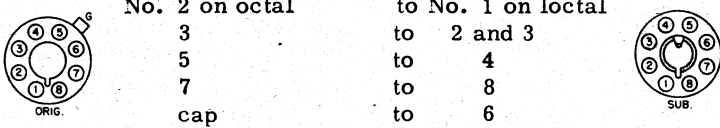
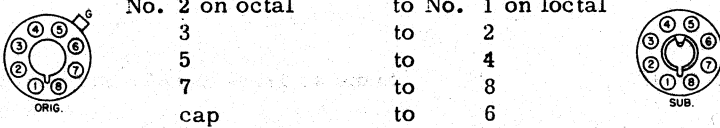
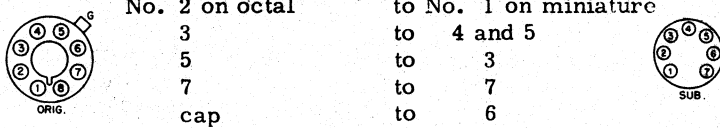
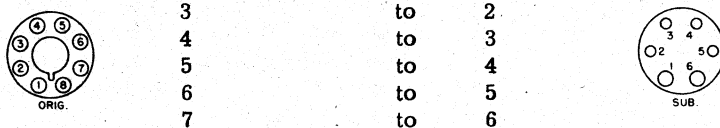

RECEIVING TUBE SUBSTITUTION GUIDE

1F7-1L4

TUBE	SUB.	PERF.	CIRCUIT CHANGES NECESSARY												
1F7	1F6	E	Reverse 1F6 to 1F7 procedure.												
1G4	1C3	G	Reverse 1C3 to 1G4 procedure.												
	1E4	G	No changes.												
	1H4	P													
	1LE3	G	Same as 1E4 to 1LE3.												
	30	P	Same as 1E4 to 30.												
1G5	1J5	G	No changes.												
1G6	1J6	P	Parallel circuits only. No changes.												
1H4	1E4	P	No changes.												
	1LE3	P	Same as 1E4 to 1LE3.												
	30	P	Same as 1E4 to 30.												
1H5	1H6	P	Connect grid cap to socket terminal No. 6. Connect Nos. 4 and 5 together.												
	1LD5	G	Change socket to loctal and rewire as follows: <table style="margin-left: 40px;"> <tr> <td>No. 2 on octal</td> <td>to No. 1 on loctal</td> </tr> <tr> <td>3</td> <td>to 2 and 3</td> </tr> <tr> <td>5</td> <td>to 4</td> </tr> <tr> <td>7</td> <td>to 8</td> </tr> <tr> <td>cap</td> <td>to 6</td> </tr> </table> 	No. 2 on octal	to No. 1 on loctal	3	to 2 and 3	5	to 4	7	to 8	cap	to 6		
No. 2 on octal	to No. 1 on loctal														
3	to 2 and 3														
5	to 4														
7	to 8														
cap	to 6														
	1LH4	E	Change socket to loctal and rewire as follows: <table style="margin-left: 40px;"> <tr> <td>No. 2 on octal</td> <td>to No. 1 on loctal</td> </tr> <tr> <td>3</td> <td>to 2</td> </tr> <tr> <td>5</td> <td>to 4</td> </tr> <tr> <td>7</td> <td>to 8</td> </tr> <tr> <td>cap</td> <td>to 6</td> </tr> </table> 	No. 2 on octal	to No. 1 on loctal	3	to 2	5	to 4	7	to 8	cap	to 6		
No. 2 on octal	to No. 1 on loctal														
3	to 2														
5	to 4														
7	to 8														
cap	to 6														
	1S5	G	Change socket to miniature or make adaptor wiring as follows: <table style="margin-left: 40px;"> <tr> <td>No. 2 on octal</td> <td>to No. 1 on miniature</td> </tr> <tr> <td>3</td> <td>to 4 and 5</td> </tr> <tr> <td>5</td> <td>to 3</td> </tr> <tr> <td>7</td> <td>to 7</td> </tr> <tr> <td>cap</td> <td>to 6</td> </tr> </table> 	No. 2 on octal	to No. 1 on miniature	3	to 4 and 5	5	to 3	7	to 7	cap	to 6		
No. 2 on octal	to No. 1 on miniature														
3	to 4 and 5														
5	to 3														
7	to 7														
cap	to 6														
1H6	1B5	E	Change socket to six prong and rewire as follows: <table style="margin-left: 40px;"> <tr> <td>No. 2 on octal</td> <td>to No. 1 on six prong</td> </tr> <tr> <td>3</td> <td>to 2</td> </tr> <tr> <td>4</td> <td>to 3</td> </tr> <tr> <td>5</td> <td>to 4</td> </tr> <tr> <td>6</td> <td>to 5</td> </tr> <tr> <td>7</td> <td>to 6</td> </tr> </table> 	No. 2 on octal	to No. 1 on six prong	3	to 2	4	to 3	5	to 4	6	to 5	7	to 6
No. 2 on octal	to No. 1 on six prong														
3	to 2														
4	to 3														
5	to 4														
6	to 5														
7	to 6														
1J5	1G5	G	No changes.												
1J6	19	E	Reverse 19 to 1J6 procedure.												
1L4	1AF4	G	Parallel circuits only. No changes.												
	1SA6	G	Same as 1T4 to 1SA6.												
	1T4	G	No changes.												
	1U4	G													

1L6-1LA6

RECEIVING TUBE SUBSTITUTION GUIDE









TUBE	SUB.	PERF.	CIRCUIT CHANGES NECESSARY														
1L6	1U6	E	Parallel circuits only. No changes.														
1LA4	1A5	G	Same as 1LB4 to 1A5.														
	1C5	G	Same as 1LB4 to 1A5. Parallel circuits only.														
	1LB4	G	No changes.														
	1Q5	G	Same as 1LB4 to 1A5. Parallel circuits only.														
	1S4	G	Same as 1LA4 to 3Q4. Parallel circuits only.														
	1T5	G	Same as 1LB4 to 1A5.														
	1W4	G	Same as 1LB4 to 1W4.														
	3Q4 3S4	P P		Electric operation only. Change socket to miniature and rewire as follows: <table border="0" style="margin-left: 40px;"> <tr> <td>No. 1 on loctal</td> <td>to No. 1 on miniature.</td> </tr> <tr> <td>2</td> <td>to 2</td> </tr> <tr> <td>3</td> <td>to 4</td> </tr> <tr> <td>6</td> <td>to 3</td> </tr> <tr> <td>8</td> <td>to 7</td> </tr> </table> <div style="display: flex; justify-content: space-around; align-items: center; margin-top: 10px;">   </div>	No. 1 on loctal	to No. 1 on miniature.	2	to 2	3	to 4	6	to 3	8	to 7			
No. 1 on loctal	to No. 1 on miniature.																
2	to 2																
3	to 4																
6	to 3																
8	to 7																
3Q5	P		Same as 1LB4 to 1A5. Series circuits only.														
1LA6	1A7	E	Change socket to octal and rewire as follows: <table border="0" style="margin-left: 40px;"> <tr> <td>No. 1 on loctal</td> <td>to No. 2 on octal</td> </tr> <tr> <td>2</td> <td>to 3</td> </tr> <tr> <td>3</td> <td>to 6</td> </tr> <tr> <td>4</td> <td>to 5</td> </tr> <tr> <td>5</td> <td>to 4</td> </tr> <tr> <td>6</td> <td>to cap</td> </tr> <tr> <td>8</td> <td>to 7</td> </tr> </table> <div style="display: flex; justify-content: space-around; align-items: center; margin-top: 10px;">   </div>	No. 1 on loctal	to No. 2 on octal	2	to 3	3	to 6	4	to 5	5	to 4	6	to cap	8	to 7
		No. 1 on loctal	to No. 2 on octal														
2	to 3																
3	to 6																
4	to 5																
5	to 4																
6	to cap																
8	to 7																
E	Same as 1LA6 to 1A7. Parallel circuits only.																
1L6	1L6	E	Same as 1LA6 to 1U6.														
1LB6	1LB6	P	Rewire as follows:  <table border="0" style="margin-left: 40px;"> <tr> <td>No. 5 to No. 7</td> </tr> <tr> <td>Connect pins No. 5 and No. 8 together.</td> </tr> </table>	No. 5 to No. 7	Connect pins No. 5 and No. 8 together.												
		No. 5 to No. 7															
Connect pins No. 5 and No. 8 together.																	
E	No changes.																
1LC6	1LC6	E	No changes.														
1R5	1R5	G	Make adaptor as follows: Break the glass envelope on a burned out loctal tube leaving the extension of the pins intact. Bend the extension of the pins so that they connect to a miniature socket according to the following: <table border="0" style="margin-left: 40px;"> <tr> <td>No. 1 on miniature</td> <td>to No. 1 on loctal</td> </tr> <tr> <td>2</td> <td>to 2</td> </tr> <tr> <td>3</td> <td>to 3</td> </tr> <tr> <td>4</td> <td>to 4</td> </tr> <tr> <td>6</td> <td>to 6</td> </tr> <tr> <td>7</td> <td>to 8</td> </tr> </table> <div style="display: flex; justify-content: space-around; align-items: center; margin-top: 10px;">   </div>	No. 1 on miniature	to No. 1 on loctal	2	to 2	3	to 3	4	to 4	6	to 6	7	to 8		
		No. 1 on miniature	to No. 1 on loctal														
2	to 2																
3	to 3																
4	to 4																
6	to 6																
7	to 8																
E	No changes.																

In case this substitution squeals on the high frequency end of the dial, change the oscillator grid resistor to 100M ohms or less if necessary.











RECEIVING TUBE SUBSTITUTION GUIDE

1LA6-1LC5

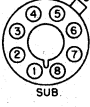
TUBE	SUB.	PERF.	CIRCUIT CHANGES NECESSARY														
1LA6	1U6	G	<p>Parallel circuits only. Change socket to miniature and rewire as follows:</p> <table border="0"> <tr> <td>No. 1 on loctal</td> <td>to No. 1 on miniature</td> </tr> <tr> <td>2</td> <td>to 2</td> </tr> <tr> <td>3</td> <td>to 3</td> </tr> <tr> <td>4</td> <td>to 4</td> </tr> <tr> <td>5</td> <td>to 5</td> </tr> <tr> <td>6</td> <td>to 6</td> </tr> <tr> <td>8</td> <td>to 7</td> </tr> </table>  	No. 1 on loctal	to No. 1 on miniature	2	to 2	3	to 3	4	to 4	5	to 5	6	to 6	8	to 7
No. 1 on loctal	to No. 1 on miniature																
2	to 2																
3	to 3																
4	to 4																
5	to 5																
6	to 6																
8	to 7																
1LB4	1A5 1T5	G G	<p>Change socket to octal and rewire as follows:</p> <table border="0"> <tr> <td>No. 1 on loctal</td> <td>to No. 2 on octal</td> </tr> <tr> <td>2</td> <td>to 3</td> </tr> <tr> <td>3</td> <td>to 4</td> </tr> <tr> <td>6</td> <td>to 5</td> </tr> <tr> <td>8</td> <td>to 7</td> </tr> </table>  	No. 1 on loctal	to No. 2 on octal	2	to 3	3	to 4	6	to 5	8	to 7				
No. 1 on loctal	to No. 2 on octal																
2	to 3																
3	to 4																
6	to 5																
8	to 7																
	1C5	G	Same as 1LB4 to 1A5. Parallel circuits only.														
	1LA4	G	No changes.														
	1Q5	G	Same as 1LB4 to 1A5. Parallel circuits only.														
	1S4	G	Same as 1LA4 to 3Q4. Parallel circuits only.														
	1W4	G	<p>Change socket to miniature and rewire as follows:</p> <table border="0"> <tr> <td>No. 1 on loctal</td> <td>to No. 1 on miniature</td> </tr> <tr> <td>2</td> <td>to 2</td> </tr> <tr> <td>3</td> <td>to 3</td> </tr> <tr> <td>6</td> <td>to 6</td> </tr> <tr> <td>8</td> <td>to 7</td> </tr> </table>  	No. 1 on loctal	to No. 1 on miniature	2	to 2	3	to 3	6	to 6	8	to 7				
No. 1 on loctal	to No. 1 on miniature																
2	to 2																
3	to 3																
6	to 6																
8	to 7																
	3Q4	P	Same as 1LA4 to 3Q4.														
	3Q5	P	Same as 1LB4 to 1A5. Series circuits only.														
	3S4	P	Same as 1LA4 to 3Q4.														
1LB6	1LA6 1LC6	P P	<p>Rewire as follows:</p> <table border="0"> <tr> <td>No. 5 to No. 8</td> <td></td> </tr> <tr> <td>7 to 5</td> <td></td> </tr> </table>	No. 5 to No. 8		7 to 5											
No. 5 to No. 8																	
7 to 5																	
1LC5	1L4	G	Same as 1LG5 to 1L4.														
	1LG5	G	No changes.														
	1LN5	G	No changes.														
	1N5	G	Same as 1LN5 to 1N5.														
	1P5	G															
	1S4	G	<p>Parallel circuits only. Change socket to miniature and rewire as follows:</p> <table border="0"> <tr> <td>No. 1 on loctal</td> <td>to No. 1 on miniature</td> </tr> <tr> <td>2</td> <td>to 2</td> </tr> <tr> <td>3</td> <td>to 4</td> </tr> <tr> <td>4</td> <td>to 1</td> </tr> <tr> <td>6</td> <td>to 3</td> </tr> <tr> <td>8</td> <td>to 7</td> </tr> </table>  	No. 1 on loctal	to No. 1 on miniature	2	to 2	3	to 4	4	to 1	6	to 3	8	to 7		
No. 1 on loctal	to No. 1 on miniature																
2	to 2																
3	to 4																
4	to 1																
6	to 3																
8	to 7																

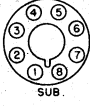

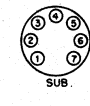

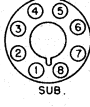



1LC5-1LD5

RECEIVING TUBE SUBSTITUTION GUIDE

TUBE	SUB.	PERF.	CIRCUIT CHANGES NECESSARY														
1LC5	1SA6	G	<p>Change socket to octal and rewire as follows:</p> <table border="0"> <tr> <td>No. 1 on loctal</td> <td>to No. 2 on octal</td> </tr> <tr> <td>2</td> <td>to 8</td> </tr> <tr> <td>3</td> <td>to 6</td> </tr> <tr> <td>4</td> <td>to 3</td> </tr> <tr> <td>6</td> <td>to 4</td> </tr> <tr> <td>8</td> <td>to 7</td> </tr> </table>  	No. 1 on loctal	to No. 2 on octal	2	to 8	3	to 6	4	to 3	6	to 4	8	to 7		
No. 1 on loctal	to No. 2 on octal																
2	to 8																
3	to 6																
4	to 3																
6	to 4																
8	to 7																
	1T4	G	Same as 1LG5 to 1L4.														
	1U4	G	Same as 1LG5 to 1L4.														
1LC6	1A7	G	<p>Change socket to octal and rewire as follows:</p> <table border="0"> <tr> <td>No. 1 on loctal</td> <td>to No. 2 on octal</td> </tr> <tr> <td>2</td> <td>to 3</td> </tr> <tr> <td>3</td> <td>to 6</td> </tr> <tr> <td>4</td> <td>to 5</td> </tr> <tr> <td>5</td> <td>to 4</td> </tr> <tr> <td>8</td> <td>to 7</td> </tr> <tr> <td>6</td> <td>to cap</td> </tr> </table>  	No. 1 on loctal	to No. 2 on octal	2	to 3	3	to 6	4	to 5	5	to 4	8	to 7	6	to cap
No. 1 on loctal	to No. 2 on octal																
2	to 3																
3	to 6																
4	to 5																
5	to 4																
8	to 7																
6	to cap																
	1B7	G	Reverse 1A7 to 1LA6 procedure. Parallel circuits only.														
	1L6	G	Same as 1LA6 to 1U6.														
	1LA6	E	No changes.														
	1LB6	P	Same as 1LA6 to 1LB6.														
	1R5	G	Same as 1LA6 to 1R5.														
	1U6	G	Same as 1LA6 to 1U6. Parallel circuits only.														
1LD5	1AF5	P	Parallel circuits only. Reverse 1AF5 to 1LD5 procedure.														
	1N6	G	<p>Change socket to octal and rewire as follows:</p> <table border="0"> <tr> <td>No. 1 on loctal</td> <td>to No. 2 on octal</td> </tr> <tr> <td>2</td> <td>to 3</td> </tr> <tr> <td>3</td> <td>to 4</td> </tr> <tr> <td>4</td> <td>to 6</td> </tr> <tr> <td>6</td> <td>to 5</td> </tr> <tr> <td>8</td> <td>to 7</td> </tr> </table>  	No. 1 on loctal	to No. 2 on octal	2	to 3	3	to 4	4	to 6	6	to 5	8	to 7		
No. 1 on loctal	to No. 2 on octal																
2	to 3																
3	to 4																
4	to 6																
6	to 5																
8	to 7																
	1S5	G	<p>Change socket to miniature and rewire as follows:</p> <table border="0"> <tr> <td>No. 1 on loctal</td> <td>to No. 1 on miniature</td> </tr> <tr> <td>2</td> <td>to 5</td> </tr> <tr> <td>3</td> <td>to 4</td> </tr> <tr> <td>4</td> <td>to 3</td> </tr> <tr> <td>6</td> <td>to 6</td> </tr> <tr> <td>8</td> <td>to 7</td> </tr> </table>  	No. 1 on loctal	to No. 1 on miniature	2	to 5	3	to 4	4	to 3	6	to 6	8	to 7		
No. 1 on loctal	to No. 1 on miniature																
2	to 5																
3	to 4																
4	to 3																
6	to 6																
8	to 7																
	1SB6	G	<p>Change socket to octal and rewire as follows:</p> <table border="0"> <tr> <td>No. 1 on loctal</td> <td>to No. 2 on octal</td> </tr> <tr> <td>2</td> <td>to 3</td> </tr> <tr> <td>3</td> <td>to 4</td> </tr> <tr> <td>4</td> <td>to 5</td> </tr> <tr> <td>6</td> <td>to 8</td> </tr> <tr> <td>8</td> <td>to 7</td> </tr> </table>  	No. 1 on loctal	to No. 2 on octal	2	to 3	3	to 4	4	to 5	6	to 8	8	to 7		
No. 1 on loctal	to No. 2 on octal																
2	to 3																
3	to 4																
4	to 5																
6	to 8																
8	to 7																

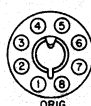



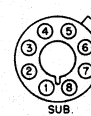

# RECEIVING TUBE SUBSTITUTION GUIDE

1LD5-1LN5

TUBE	SUB.	PERF.	CIRCUIT CHANGES NECESSARY												
1LD5	1U5	G	Change socket to miniature and rewire as follows: <table style="margin-left: 40px;"> <tr> <td>No. 1 on loctal</td> <td>to No. 1 on miniature</td> </tr> <tr> <td>2</td> <td>to 2</td> </tr> <tr> <td>3</td> <td>to 3</td> </tr> <tr> <td>4</td> <td>to 4</td> </tr> <tr> <td>6</td> <td>to 6</td> </tr> <tr> <td>8</td> <td>to 7</td> </tr> </table> <div style="display: flex; justify-content: space-around; align-items: center;">   </div>	No. 1 on loctal	to No. 1 on miniature	2	to 2	3	to 3	4	to 4	6	to 6	8	to 7
No. 1 on loctal	to No. 1 on miniature														
2	to 2														
3	to 3														
4	to 4														
6	to 6														
8	to 7														
1LE3	1C3	G	Reverse 1C3 to 1LE3 procedure.												
	1E4	G	Reverse 1E4 to 1LE3 procedure. Not a good oscillator.												
	1G4	G	Change socket to octal and rewire as follows: <table style="margin-left: 40px;"> <tr> <td>No. 1 on loctal</td> <td>to No. 2 on octal</td> </tr> <tr> <td>2</td> <td>to 3</td> </tr> <tr> <td>6</td> <td>to 5</td> </tr> <tr> <td>8</td> <td>to 7</td> </tr> </table> <div style="display: flex; justify-content: space-around; align-items: center;">   </div>	No. 1 on loctal	to No. 2 on octal	2	to 3	6	to 5	8	to 7				
No. 1 on loctal	to No. 2 on octal														
2	to 3														
6	to 5														
8	to 7														
	1H4	P	Reverse 1E4 to 1LE3 procedure. Not a good oscillator.												
	1293	G	Parallel circuits only. No changes.												
1LG5	1L4	G	Change socket to miniature and rewire as follows: <table style="margin-left: 40px;"> <tr> <td>No. 1 on loctal</td> <td>to No. 1 on miniature</td> </tr> <tr> <td>2</td> <td>to 2</td> </tr> <tr> <td>3</td> <td>to 3</td> </tr> <tr> <td>4</td> <td>to 5</td> </tr> <tr> <td>6</td> <td>to 6</td> </tr> <tr> <td>8</td> <td>to 7</td> </tr> </table> <div style="display: flex; justify-content: space-around; align-items: center;">   </div>	No. 1 on loctal	to No. 1 on miniature	2	to 2	3	to 3	4	to 5	6	to 6	8	to 7
No. 1 on loctal	to No. 1 on miniature														
2	to 2														
3	to 3														
4	to 5														
6	to 6														
8	to 7														
	1T4	G													
	1U4	G													
	1LC5	G	No changes.												
1LH4	1H5	E	Change socket to octal and rewire as follows: <table style="margin-left: 40px;"> <tr> <td>No. 1 on loctal</td> <td>to No. 2 on octal</td> </tr> <tr> <td>2</td> <td>to 3</td> </tr> <tr> <td>4</td> <td>to 5</td> </tr> <tr> <td>8</td> <td>to 7</td> </tr> <tr> <td>6</td> <td>to cap</td> </tr> </table> <div style="display: flex; justify-content: space-around; align-items: center;">   </div>	No. 1 on loctal	to No. 2 on octal	2	to 3	4	to 5	8	to 7	6	to cap		
No. 1 on loctal	to No. 2 on octal														
2	to 3														
4	to 5														
8	to 7														
6	to cap														
	1S5	G	Make adaptor as follows: <table style="margin-left: 40px;"> <tr> <td>No. 1 on base</td> <td>to No. 1 on top</td> </tr> <tr> <td>2</td> <td>to 5 and 4</td> </tr> <tr> <td>4</td> <td>to 3</td> </tr> <tr> <td>6</td> <td>to 6</td> </tr> <tr> <td>8</td> <td>to 7</td> </tr> </table>	No. 1 on base	to No. 1 on top	2	to 5 and 4	4	to 3	6	to 6	8	to 7		
No. 1 on base	to No. 1 on top														
2	to 5 and 4														
4	to 3														
6	to 6														
8	to 7														
1LN5	1LC5	E	No changes.												
	1N5	E	Change socket to octal and rewire as follows: <table style="margin-left: 40px;"> <tr> <td>No. 1 on loctal</td> <td>to No. 2 on octal</td> </tr> <tr> <td>2</td> <td>to 3</td> </tr> <tr> <td>3</td> <td>to 4</td> </tr> <tr> <td>8</td> <td>to 7</td> </tr> <tr> <td>6</td> <td>to cap</td> </tr> </table> <div style="display: flex; justify-content: space-around; align-items: center;">   </div>	No. 1 on loctal	to No. 2 on octal	2	to 3	3	to 4	8	to 7	6	to cap		
No. 1 on loctal	to No. 2 on octal														
2	to 3														
3	to 4														
8	to 7														
6	to cap														
	1P5	G													
	1S4	G	Same as 1LC5 to 1S4. Parallel circuits only.												

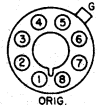
1LN5-1N6

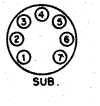
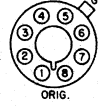
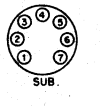
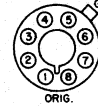
RECEIVING TUBE SUBSTITUTION GUIDE

TUBE	SUB.	PERF.	CIRCUIT CHANGES NECESSARY
1LN5	1S5	P	Change socket to miniature and rewire as follows: Nos. 1 and 4 on loctal to No. 1 on miniature 2 to 5 3 to 4 4 to 1 6 to 6 8 and 5 to 7
			 
	1SA6	G	Same as 1LC5 to 1SA6.
	3A8	P	Electric operation only. Same as 1LN5 to 1N5. Connect nothing to pins not used.
1N5	1D5	P	No changes. 1D5 rated 60 mils on 2 volts and pulls less than 50 on 1.4 volt.
	1LC5	G	Same as 1N5 to 1LN5.
	1LN5	E	Change socket to loctal and rewire as follows: No. 2 on octal to No. 1 on loctal 3 to 2 4 to 3 7 to 8 cap to 6 Short loctal terminals 4 and 5
			 
	1P5	G	No changes.
	1S4	P	Parallel circuits only. Change socket to miniature and rewire as follows: No. 2 on octal to No. 1 on miniature 3 to 2 4 to 4 7 to 7 cap to 3
			 
	1S5	G	Change socket to miniature and rewire as follows: No. 2 on octal to No. 1 on miniature 3 to 5 4 to 4 7 to 7 cap to 6
			 
	1SA6	G	Make adaptor as follows: No. 2 on base to No. 2 on top 3 to 8 4 to 6 7 to 7 and 3 cap to 4
	1T4	G	Change socket to miniature or make adaptor as follows: No. 2 on octal to No. 7 on miniature. 3 to 2 4 to 3 7 to 1 cap to 6 This substitution squeals in some cases, works best as r-f tube.
			 
	3A8	P	Electric operation only. Remove and tape up wire if any anchored on Nos. 5, 6 and 8.
1N6	1LD5	G	Reverse 1LD5 to 1N6 procedure.





## RECEIVING TUBE SUBSTITUTION GUIDE

1N6-1S4

TUBE	SUB.	PERF.	CIRCUIT CHANGES NECESSARY
1N6	1SB6	G	Rewire as follows: No. 5 to No. 8 6 to 5
1P5	1N5	G	No changes.
	1S4	P	Parallel circuits only. Same as 1N5 to 1S4.
	1SA6	G	Same as 1N5 to 1SA6.
	1T4	G	Same as 1N5 to 1T4.
1Q5	1A5	G	Parallel circuits only. No changes.
	1C5	P	No changes. Bias different but tone reasonably good.
	3B5	P	Move No. 7 to No. 8 and short No. 2 and 7 together.
	3C5	P	
	3Q4	P	Same as 1C5 to 3Q4.
	3Q5	P	Move No. 7 to No. 8 and short No. 2 and 7 together.
1Q6	3S4	P	Same as 1C5 to 3Q4.
	1S6	E	Rewire as follows:
	1T6	E	No. 1 to No. 4 7 to 1 2 to 3
1R4/1294	1A3	P	Reverse 1A3 to 1R4/1294 procedure.
1R5	1A7	G	Where extra space permits. Reverse 1A7 to 1R5 procedure.
	1LA6	G	Where space permits. Reverse 1LA6 to 1R5 procedure.
	1LC6	G	
1S4	1LC5	G	Where space permits. Parallel circuits only. Reverse 1LC5 to 1S4 procedure.
	1LN5	G	
	1N5	G	Where space permits. Parallel circuits only. Reverse 1N5 to 1S4 procedure.
	1P5	G	
	1S5	P	Parallel circuits only. Rewire as follows: Nos. 2 and 6 to No. 5 3 to 6 5 to 1
	1L4	P	Parallel circuits only. Rewire as follows:
	1T4	P	
	1U4	P	No. 6 to No. 2 3 to 6 4 to 3

1S4-1T4

RECEIVING TUBE SUBSTITUTION GUIDE

TUBE	SUB.	PERF.	CIRCUIT CHANGES NECESSARY
1S4	3E5	G	Parallel circuits only. Rewire as follows: No. 6 to No. 2 3 to 6 4 to 3 5 to 1 7 to 5 Connect 1 and 7 together.
1S5	1AF5	E	Parallel circuits only. No changes.
	1LD5	G	Where space permits. Reverse 1LD5 to 1S5 procedure.
	1SB6	G	Where space permits. Reverse 1SB6 to 1S5 procedure.
	1U5	E	Rewire as follows: No. 5 to No. 2 Reverse 3 and 4
1S6	1Q6	E	Rewire as follows: No. 3 to No. 2 1 to 7
	1T6	E	No changes.
1SA6	1L4	G	Reverse 1T4 to 1SA6 procedure
	1LC5	G	Reverse 1LC5 to 1SA6 procedure.
	1LN5	G	
	1N5	G	Reverse 1N5 to 1SA6 procedure.
	1T4	G	Reverse 1T4 to 1SA6 procedure.
	1U4	G	
1SB6	1H5	G	Extend wire from No. 8 to cap.
	1LD5	G	Reverse 1LD5 to 1SB6 procedure.
	1S5	G	Change socket to miniature and rewire as follows: No. 2 on octal to No. 1 on miniature 3 to 5 4 to 4 5 to 3 7 to 7 8 to 6
			 
1T4	1AF4	G	Parallel circuits only. No changes.
	1L4	G	No changes.
	1SA6	E	Where space permits. Change socket to octal and rewire as follows: No. 1 on miniature to No. 2 on octal 2 to 8 3 to 6 6 to 4 7 to 7 Connect Nos. 2 and 3 together.
			 







## RECEIVING TUBE SUBSTITUTION GUIDE

1T4 - 1V5

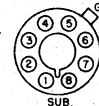
TUBE	SUB.	PERF.	CIRCUIT CHANGES NECESSARY			
1T4	1U4	G	No changes.			
1T5	1A5	G	No changes. 1T5 pulls 10 mils more but it works OK.			
	1C5	G	Parallel circuits only. No changes.			
	1D8	P	Remove and tape up wires if any anchored on No. 6 and 8. Parallel circuits only.			
	1G4	P	No changes. Emergency works good in most cases.			
	1LA4	P	Same as 1A5 to 1LA4			
	1LB4	P				
	1Q5	G	Parallel circuits only. No changes.			
	1S4	G	Same as 3Q4 to 3S4 parallel circuits only except omit connection No. 8 on octal to No. 5 on miniature.			
	3Q4	P	Electric operation only. Same as 3Q5 to 3S4 but connect nothing to No. 5			
	3S4	P	on miniature.			
1T6	1Q6	E	Rewire as follows:			
			<table style="margin-left: auto; margin-right: auto;"> <tr> <td style="padding-right: 20px;">No. 3</td> <td>to No. 2</td> </tr> <tr> <td style="padding-right: 20px;">1</td> <td>to 7</td> </tr> </table>	No. 3	to No. 2	1
No. 3	to No. 2					
1	to 7					
	1S6	E	No changes.			
1U4	1AF4	G	Parallel circuits only. No changes.			
	1L4	G	No changes.			
	1S5	G	Rewire as follows:			
			<table style="margin-left: auto; margin-right: auto;"> <tr> <td style="padding-right: 20px;">No. 5</td> <td>to No. 1</td> </tr> <tr> <td style="padding-right: 20px;">2</td> <td>to 5</td> </tr> <tr> <td style="padding-right: 20px;">3</td> <td>to 4</td> </tr> </table>	No. 5	to No. 1	2
No. 5	to No. 1					
2	to 5					
3	to 4					
	1SA6	G	Where space permits. Same as 1T4 to 1SA6.			
	1T4	G	No changes.			
1U5	1S5	E	Rewire as follows:			
			<table style="margin-left: auto; margin-right: auto;"> <tr> <td style="padding-right: 20px;">No. 2</td> <td>to No. 5</td> </tr> <tr> <td style="padding-right: 20px;">Reverse 3 and</td> <td>4</td> </tr> </table>	No. 2	to No. 5	Reverse 3 and
No. 2	to No. 5					
Reverse 3 and	4					
1U6	1L6	E	Parallel circuits only. No changes.			
1V	6Z3	E	No changes.			
	12Z3	G	No changes necessary. Series circuits only. Six volts added to the filament string makes no difference.			
1V2			No practical substitute.			
1V5	1AC5	E	No changes.			

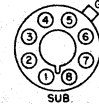
1W4-2B7

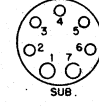

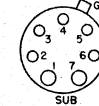
RECEIVING TUBE SUBSTITUTION GUIDE

TUBE	SUB.	PERF.	CIRCUIT CHANGES NECESSARY
1W4	1LA4 1LB4	G G	Where space permits. Reverse 1LB4 to 1W4 procedure.
	3E5	G	Rewire as follows: No. 7 to No. 5 Connect 1 and 7 together
1W5	1V5	P	No changes.
1X2	1B3	G	Where space permits. Change socket to octal and rewire as follows:  Nos. 1,3,4,6 on miniature to No. 2 on octal 2, 5, 7 to 7 cap to cap 
1Z2	1B3	G	Where space permits. Change socket to octal and rewire as follows:  Nos. 1,3,4,6 on miniature to No. 2 on octal 2,7,5 to 7 cap to cap 
2A3	45	G	No changes.
2A4G			No practical substitute.
2A5	47	G	Reverse 47 to 2A5 procedure.
	59	G	Change socket to seven prong and rewire as follows: No. 1 on six prong to No. 1 on seven prong 2 to 2 3 to 3 4 to 4 5 to 6 6 to 7 Short Nos. 5 and 6 together.  
	1619	G	Parallel circuits only. Make adaptor as follows: No. 1 on base to No. 2 on top 2 to 3 3 to 4 4 to 5 5 to 8 6 to 7 There are or will be many used 1619 tubes available.
2A6	2B7	P	Change socket to seven prong and rewire as follows: No. 1 on six prong to No. 1 on seven prong 2 to 2 and 3 3 to 4 4 to 5 5 to 6 6 to 7 cap to cap  
	55	E	Parallel circuits only. No changes.
2A7	2A7S	E	No changes.
2B7	6B7	E	Heater voltage -- current ratings differ.

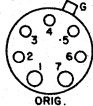
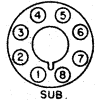

RECEIVING TUBE SUBSTITUTION GUIDE

2B7S-2G5

TUBE	SUB.	PERF.	CIRCUIT CHANGES NECESSARY																								
2B7S			No practical substitute.																								
2B25			No practical substitute.																								
2C4			No practical substitute.																								
2C21	6SN7	G	Change socket to octal and rewire as follows: <table border="0" style="margin-left: 40px;"> <tr> <td>No. 1 on seven prong</td> <td>to</td> <td>No. 8 on octal</td> </tr> <tr> <td>2</td> <td>to</td> <td>3</td> </tr> <tr> <td>3</td> <td>to</td> <td>2</td> </tr> <tr> <td>4</td> <td>to</td> <td>4</td> </tr> <tr> <td>5</td> <td>to</td> <td>5</td> </tr> <tr> <td>6</td> <td>to</td> <td>6</td> </tr> <tr> <td>7</td> <td>to</td> <td>7</td> </tr> <tr> <td>cap</td> <td>to</td> <td>1</td> </tr> </table> <div style="display: flex; justify-content: space-around; align-items: center; margin-top: 10px;">   </div>	No. 1 on seven prong	to	No. 8 on octal	2	to	3	3	to	2	4	to	4	5	to	5	6	to	6	7	to	7	cap	to	1
No. 1 on seven prong	to	No. 8 on octal																									
2	to	3																									
3	to	2																									
4	to	4																									
5	to	5																									
6	to	6																									
7	to	7																									
cap	to	1																									
2C22	6AD5 6AF5 6C5 6J5 6P5	P P P P P	Rewire as follows: Connect grid cap to No. 5 Connect plate cap to No. 3																								
2C51	7F8	G	Where space permits. Change socket to loctal and rewire as follows: <table border="0" style="margin-left: 40px;"> <tr> <td>No. 1 on noval</td> <td>to</td> <td>No. 2 on loctal</td> </tr> <tr> <td>2</td> <td>to</td> <td>4</td> </tr> <tr> <td>3</td> <td>to</td> <td>1</td> </tr> <tr> <td>4</td> <td>to</td> <td>3</td> </tr> <tr> <td>6</td> <td>to</td> <td>6</td> </tr> <tr> <td>7</td> <td>to</td> <td>8</td> </tr> <tr> <td>8</td> <td>to</td> <td>5</td> </tr> <tr> <td>9</td> <td>to</td> <td>7</td> </tr> </table> <div style="display: flex; justify-content: space-around; align-items: center; margin-top: 10px;">   </div>	No. 1 on noval	to	No. 2 on loctal	2	to	4	3	to	1	4	to	3	6	to	6	7	to	8	8	to	5	9	to	7
No. 1 on noval	to	No. 2 on loctal																									
2	to	4																									
3	to	1																									
4	to	3																									
6	to	6																									
7	to	8																									
8	to	5																									
9	to	7																									
	5670	G	Parallel circuits only. No changes.																								
2C52	12SN7 12SX7	P P	No changes.																								
2D21			No practical substitute.																								
2E5	6E5	E	Heater voltage-current ratings differ.																								
	6T5	E	Same as above.																								
	6U5	E	Same as above.																								
2E26			No practical substitute.																								
2E30	5812	G	No changes.																								
2E31	2E32	E	No changes.																								
2E32	2E31	E	No changes.																								
2E35	2E36	E	No changes.																								
2E36	2E35	E	No changes.																								
2E41	2E42	E	No changes.																								
2E42	2E41	E	No changes.																								
2G5	6U5/6G5	E	Heater voltage-current ratings differ.																								

**2G21-3B5**

**RECEIVING TUBE SUBSTITUTION GUIDE**

TUBE	SUB.	PERF.	CIRCUIT CHANGES NECESSARY
2G21	2G22	E	No changes.
2G22	2G21	E	No changes.
2S/4S			No practical substitute.
2V3	2X2/879	P	Parallel circuits only. Change socket to four prong and rewire as follows:



No. 2 on octal  
cap  
7

to No. 1 on four prong  
to cap  
to 4

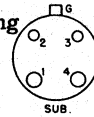

2W3	2Z2/G84	E	Reverse 2Z2/G84 to 2W3 procedure.
	82	P	For half wave operation only. Change socket to four prong and rewire as follows:



No. 2 on octal  
4  
8

to No. 1 on four prong  
to 2 and 3  
to 4

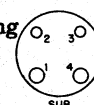

2X2/879	2V3	P	Reverse 2V3 to 2X2/879 procedure. Examine power transformer and determine whether it will handle additional filament current.
2Y2			No practical substitute.

2Z2/G84	2W3	E	Change socket to octal and rewire as follows:
---------	-----	---	---

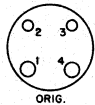

No. 1 on four prong  
2  
4

to No. 2 on octal  
to 4  
to 8



3A4	3Q4 3S4	P P	Parallel circuits only. Rewire as follows:  Reverse connections on terminals 3 and 4.
-----	------------	--------	---

	3V4	P	Parallel circuits only. Rewire as follows:
--	-----	---	--

No. 6  
4

to No. 2  
to 6

3A5	3C6	P	Parallel circuits only. Change socket to loctal and rewire as follows:
-----	-----	---	--

No. 1 on miniature  
2  
3  
4  
5  
6  
7

to No. 1 on loctal  
to 3  
to 4  
to 7  
to 5  
to 6  
to 8



3A8GT			No practical substitute.
-------	--	--	--------------------------





3B4			No practical substitute.
-----	--	--	--------------------------

3B5	3C5	E	No changes.
-----	-----	---	-------------

	3LE4 3LF4	E E	Same as 3Q5 to 3LF4.
--	--------------	--------	----------------------





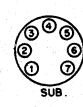



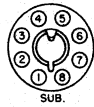

## RECEIVING TUBE SUBSTITUTION GUIDE

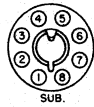
3B5-3E6

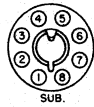
TUBE	SUB.	PERF.	CIRCUIT CHANGES NECESSARY																					
3B5	3Q5	E	No changes.																					
	3S4	G	Same as 3Q5 to 3S4 except omit connection of No. 8 on octal to No. 5 on miniature.																					
3B7	1291	E	No changes.																					
3B7/1291	3A5	P	Change socket to miniature and rewire as follows: <table style="margin-left: 40px; border: none;"> <tr> <td style="text-align: right;">No. 1 on octal</td> <td style="text-align: center;">to</td> <td style="text-align: left;">No. 1 on miniature</td> </tr> <tr> <td style="text-align: right;">2</td> <td style="text-align: center;">to</td> <td style="text-align: left;">2</td> </tr> <tr> <td style="text-align: right;">3</td> <td style="text-align: center;">to</td> <td style="text-align: left;">3</td> </tr> <tr> <td style="text-align: right;">4</td> <td style="text-align: center;">to</td> <td style="text-align: left;">4</td> </tr> <tr> <td style="text-align: right;">6</td> <td style="text-align: center;">to</td> <td style="text-align: left;">5</td> </tr> <tr> <td style="text-align: right;">7</td> <td style="text-align: center;">to</td> <td style="text-align: left;">6</td> </tr> <tr> <td style="text-align: right;">8</td> <td style="text-align: center;">to</td> <td style="text-align: left;">7</td> </tr> </table>	No. 1 on octal	to	No. 1 on miniature	2	to	2	3	to	3	4	to	4	6	to	5	7	to	6	8	to	7
No. 1 on octal	to	No. 1 on miniature																						
2	to	2																						
3	to	3																						
4	to	4																						
6	to	5																						
7	to	6																						
8	to	7																						
			 																					
	3C6	P	Parallel circuits only. Rewire as follows: <table style="margin-left: 40px; border: none;"> <tr> <td style="text-align: right;">No. 6</td> <td style="text-align: center;">to</td> <td style="text-align: left;">No. 5</td> </tr> <tr> <td style="text-align: right;">7</td> <td style="text-align: center;">to</td> <td style="text-align: left;">6</td> </tr> <tr> <td style="text-align: right;">4</td> <td style="text-align: center;">to</td> <td style="text-align: left;">7</td> </tr> <tr> <td style="text-align: right;">3</td> <td style="text-align: center;">to</td> <td style="text-align: left;">4</td> </tr> <tr> <td style="text-align: right;">2</td> <td style="text-align: center;">to</td> <td style="text-align: left;">3</td> </tr> </table>	No. 6	to	No. 5	7	to	6	4	to	7	3	to	4	2	to	3						
No. 6	to	No. 5																						
7	to	6																						
4	to	7																						
3	to	4																						
2	to	3																						
3C5	3B5	E	No changes.																					
	3Q5	E																						
	3LE4	E	Same as 3Q5 to 3LF4																					
	3LF4	E																						
3C6	3A5	P	Parallel circuits only. Reverse 3A5 to 3C6 procedure.																					
	3B7/1291	G	Parallel circuits only. Reverse 3B7/1291 to 3C6 procedure.																					
3D6/1299	3LF4	G	Parallel circuits only. No changes.																					
	3S4	G	Parallel circuits only. Change socket to miniature and rewire as follows: <table style="margin-left: 40px; border: none;"> <tr> <td style="text-align: right;">No. 1 on octal</td> <td style="text-align: center;">to</td> <td style="text-align: left;">No. 1 on miniature</td> </tr> <tr> <td style="text-align: right;">2</td> <td style="text-align: center;">to</td> <td style="text-align: left;">2</td> </tr> <tr> <td style="text-align: right;">3</td> <td style="text-align: center;">to</td> <td style="text-align: left;">4</td> </tr> <tr> <td style="text-align: right;">6</td> <td style="text-align: center;">to</td> <td style="text-align: left;">3</td> </tr> <tr> <td style="text-align: right;">7</td> <td style="text-align: center;">to</td> <td style="text-align: left;">5</td> </tr> <tr> <td style="text-align: right;">8</td> <td style="text-align: center;">to</td> <td style="text-align: left;">7</td> </tr> </table>	No. 1 on octal	to	No. 1 on miniature	2	to	2	3	to	4	6	to	3	7	to	5	8	to	7			
No. 1 on octal	to	No. 1 on miniature																						
2	to	2																						
3	to	4																						
6	to	3																						
7	to	5																						
8	to	7																						
			 																					
	3Q5	E	Parallel circuits only. Reverse 3C5 to 3LE4 procedure.																					
	3V4	G	Parallel circuits only. Change socket to miniature and rewire as follows: <table style="margin-left: 40px; border: none;"> <tr> <td style="text-align: right;">No. 1 on octal</td> <td style="text-align: center;">to</td> <td style="text-align: left;">No. 1 on miniature</td> </tr> <tr> <td style="text-align: right;">2</td> <td style="text-align: center;">to</td> <td style="text-align: left;">2</td> </tr> <tr> <td style="text-align: right;">3</td> <td style="text-align: center;">to</td> <td style="text-align: left;">3</td> </tr> <tr> <td style="text-align: right;">6</td> <td style="text-align: center;">to</td> <td style="text-align: left;">6</td> </tr> <tr> <td style="text-align: right;">7</td> <td style="text-align: center;">to</td> <td style="text-align: left;">5</td> </tr> <tr> <td style="text-align: right;">8</td> <td style="text-align: center;">to</td> <td style="text-align: left;">7</td> </tr> </table>	No. 1 on octal	to	No. 1 on miniature	2	to	2	3	to	3	6	to	6	7	to	5	8	to	7			
No. 1 on octal	to	No. 1 on miniature																						
2	to	2																						
3	to	3																						
6	to	6																						
7	to	5																						
8	to	7																						
			 																					
3E5	3S4	G	Parallel circuits only. Rewire as follows: <table style="margin-left: 40px; border: none;"> <tr> <td style="text-align: right;">No. 3</td> <td style="text-align: center;">to</td> <td style="text-align: left;">No. 4</td> </tr> <tr> <td style="text-align: right;">6</td> <td style="text-align: center;">to</td> <td style="text-align: left;">3</td> </tr> </table>	No. 3	to	No. 4	6	to	3															
No. 3	to	No. 4																						
6	to	3																						
	3V4	G	Parallel circuits only. No changes.																					
3E6			No practical substitute.																					

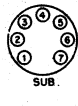

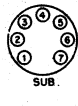
**3LE4-3Q5**

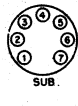
**RECEIVING TUBE SUBSTITUTION GUIDE**

TUBE	SUB.	PERF.	CIRCUIT CHANGES NECESSARY												
3LE4	3LF4	E	No changes.												
	3V4	G	Same as 3D6/1299 to 3V4.												
3LF4	3D6/1299	G	Parallel circuits only. No changes.												
	3V4	G	Same as 3D6/1299 to 3V4.												
3Q4	3A4	P	Parallel circuits only. Rewire as follows:  Reverse No. 3 and No. 4												
	3D6/1299	G	Parallel circuits only. Reverse 3D6/1299 to 3Q4 procedure.												
	3E5	G	Parallel circuits only. Rewire as follows:  <table border="0" style="margin-left: 100px;"> <tr> <td>No. 6</td> <td>to No. 2</td> </tr> <tr> <td>3</td> <td>to 6</td> </tr> <tr> <td>4</td> <td>to 3</td> </tr> </table>	No. 6	to No. 2	3	to 6	4	to 3						
No. 6	to No. 2														
3	to 6														
4	to 3														
3LE4		G	Reverse 3D6/1299 to 3Q4 procedure.												
3LF4		G													
	3S4	G	No changes.												
	3V4	G	Rewire as follows:  <table border="0" style="margin-left: 100px;"> <tr> <td>No. 6</td> <td>to No. 2</td> </tr> <tr> <td>3</td> <td>to 6</td> </tr> <tr> <td>4</td> <td>to 3</td> </tr> </table>	No. 6	to No. 2	3	to 6	4	to 3						
No. 6	to No. 2														
3	to 6														
4	to 3														
3Q5	1A5	P	No changes. For electric operation only. Battery operation requires resistor 25 to 30 ohms in one of the A leads.												
	1G4	P													
	1LA4	P	Electric operation only. Same as 1A5 to 1LB4.												
	1LB4	P													
	1T4	P	Same as 1A5 to 1T4. Electric operation only. Emergency substitution.												
	1T5	P	No changes. Electric operation only.												
	3B5	E	No changes.												
	3C5	E	No changes.												
3LF4		E	Change socket to octal and rewire as follows:  <table border="0" style="margin-left: 100px;"> <tr> <td>No. 2 on octal</td> <td>to No. 1 on loctal</td> </tr> <tr> <td>3</td> <td>to 2</td> </tr> <tr> <td>4</td> <td>to 3</td> </tr> <tr> <td>5</td> <td>to 6</td> </tr> <tr> <td>7</td> <td>to 8</td> </tr> <tr> <td>8</td> <td>to 7</td> </tr> </table>	No. 2 on octal	to No. 1 on loctal	3	to 2	4	to 3	5	to 6	7	to 8	8	to 7
No. 2 on octal	to No. 1 on loctal														
3	to 2														
4	to 3														
5	to 6														
7	to 8														
8	to 7														
3LE4		E													
			<table border="0" style="margin-left: 100px;"> <tr> <td></td> <td></td> <td></td> </tr> <tr> <td style="text-align: center;">ORIG.</td> <td></td> <td style="text-align: center;">SUB.</td> </tr> </table>				ORIG.		SUB.						
															
ORIG.		SUB.													
3Q4		G	Change socket to miniature and rewire as follows:  <table border="0" style="margin-left: 100px;"> <tr> <td>No. 2 on octal</td> <td>to No. 1 on miniature</td> </tr> <tr> <td>3</td> <td>to 2</td> </tr> <tr> <td>4</td> <td>to 4</td> </tr> <tr> <td>5</td> <td>to 3</td> </tr> <tr> <td>7</td> <td>to 7</td> </tr> <tr> <td>8</td> <td>to 5</td> </tr> </table>	No. 2 on octal	to No. 1 on miniature	3	to 2	4	to 4	5	to 3	7	to 7	8	to 5
No. 2 on octal	to No. 1 on miniature														
3	to 2														
4	to 4														
5	to 3														
7	to 7														
8	to 5														
3S4		G													
			<table border="0" style="margin-left: 100px;"> <tr> <td></td> <td></td> <td></td> </tr> <tr> <td style="text-align: center;">ORIG.</td> <td></td> <td style="text-align: center;">SUB.</td> </tr> </table>				ORIG.		SUB.						
															
ORIG.		SUB.													

RECEIVING TUBE SUBSTITUTION GUIDE

3Q5-5T4

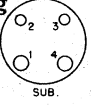
TUBE	SUB.	PERF.	CIRCUIT CHANGES NECESSARY												
3Q5	3V4	G	Change socket to miniature and rewire as follows: <table border="0"> <tr> <td>No. 2 on octal</td> <td>to No. 1 on miniature</td> </tr> <tr> <td>3</td> <td>to 2</td> </tr> <tr> <td>4</td> <td>to 3</td> </tr> <tr> <td>5</td> <td>to 6</td> </tr> <tr> <td>7</td> <td>to 7</td> </tr> <tr> <td>8</td> <td>to 5</td> </tr> </table>	No. 2 on octal	to No. 1 on miniature	3	to 2	4	to 3	5	to 6	7	to 7	8	to 5
No. 2 on octal	to No. 1 on miniature														
3	to 2														
4	to 3														
5	to 6														
7	to 7														
8	to 5														
			 												
3S4	3E5	G	Parallel circuits only. Same as 3Q4 to 3E5.												
	3Q4	G	No changes.												
	3V4	G	Same as 3Q4 to 3V4.												
3V4	3A4	P	Parallel circuits only. Reverse 3A4 to 3V4 procedure.												
	3E5	G	Parallel circuits only. No changes.												
	3Q4	G	Reverse 3Q4 to 3V4 procedure.												
	3S4	G													
4A6			No practical substitute.												
5A6			No practical substitute.												
5AX4	5AZ4	G	No changes.												
	5U4	G													
	5V4	G													
	5W4	G													
	5Y3	G													
	5Z4	G													
5AZ4	5AX4	G	No changes.												
	5U4	G													
	5V4	G													
	5W4	G													
	5Y3	G													
	5Z4	G													
5R4GY	5T4	G	No changes. Use only where inverse peak voltage does not exceed 450 volts per plate.												
	5U4	G													
	5V4	P													
	5Y3	P													
	5Z4	P													
	5X4	G	Same as 5T4 to 5Y4												
	5Y4	P													
	5Z3	G	Where inverse peak voltage per plate does not exceed 450 volts. Change socket to four prong and rewire as follows:												
	80	P													
	83	G													
	83V	G													
			<table border="0"> <tr> <td>No. 2 on octal</td> <td>to No. 1 on four prong</td> </tr> <tr> <td>4</td> <td>to 2</td> </tr> <tr> <td>6</td> <td>to 3</td> </tr> <tr> <td>8</td> <td>to 4</td> </tr> </table>	No. 2 on octal	to No. 1 on four prong	4	to 2	6	to 3	8	to 4				
No. 2 on octal	to No. 1 on four prong														
4	to 2														
6	to 3														
8	to 4														
			 												
5T4	5AX4	G	No changes.												
	5AZ4	G													
	5U4	G													
	5V4	G													
	5W4	G													
	5Y3	G													
	5Z4	G													

**5T4-5X4**

**RECEIVING TUBE SUBSTITUTION GUIDE**

TUBE	SUB.	PERF.	CIRCUIT CHANGES NECESSARY										
5T4	5Y4	G	Make adaptor as follows: <table style="margin-left: 40px;"> <tr> <td>No. 1 on base</td> <td>to No. 1 on top</td> </tr> <tr> <td>2</td> <td>to 8</td> </tr> <tr> <td>4</td> <td>to 3</td> </tr> <tr> <td>6</td> <td>to 5</td> </tr> <tr> <td>8</td> <td>to 7</td> </tr> </table>	No. 1 on base	to No. 1 on top	2	to 8	4	to 3	6	to 5	8	to 7
No. 1 on base	to No. 1 on top												
2	to 8												
4	to 3												
6	to 5												
8	to 7												
5U4	5AX4 5AZ4 5T4 5V4 5W4 5Y3 5Z4 5Y4	G G G G G G G G	No changes.       Same as 5T4 to 5Y4.										
	5Z3 80 83 83V	E G G G	Same as 5R4GY to 5Z3.										
5V4	5AX4 5AZ4 5T4 5U4 5W4 5Y3 5Z4 5Y4	G G G G G G G G	No changes.       Same as 5T4 to 5Y4.										
	5Z3 80 83 83V	G G G G	Same as 5R4GY to 5Z3.										
5W4	5AX4 5AZ4 5T4 5U4 5V4 5Y3 5Z4	G G G G G G G	No changes.       Same as 5T4 to 5Y4.										
	5Y4 5Z3 80 83 83V	G G G G G	Same as 5T4 to 5Y4. Same as 5R4GY to 5Z3.										
5X3	5Z3 80 83 83V 1275	G G G G G	No changes.										
5X4	5T4 5U4 5V4 5Y3 5Z4	G G G G G	Rewire as follows: <table style="margin-left: 40px;"> <tr> <td>No. 7</td> <td>to No. 2</td> </tr> <tr> <td>3</td> <td>to 4</td> </tr> <tr> <td>5</td> <td>to 6</td> </tr> </table>	No. 7	to No. 2	3	to 4	5	to 6				
No. 7	to No. 2												
3	to 4												
5	to 6												



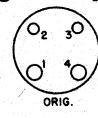
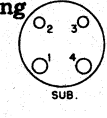
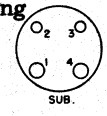

RECEIVING TUBE SUBSTITUTION GUIDE

5X4-5Z3

TUBE	SUB.	PERF.	CIRCUIT CHANGES NECESSARY									
5X4	5Y4	G	No changes.									
	5Z3	G	Change octal to four prong socket and rewire as follows: <table border="0"> <tr> <td>No. 3 on octal</td> <td>to No. 2 on four prong</td> </tr> <tr> <td>5</td> <td>to 3</td> </tr> <tr> <td>7</td> <td>to 1</td> </tr> <tr> <td>8</td> <td>to 4</td> </tr> </table>	No. 3 on octal	to No. 2 on four prong	5	to 3	7	to 1	8	to 4	
	No. 3 on octal	to No. 2 on four prong										
	5	to 3										
	7	to 1										
8	to 4											
80	P											
83	G											
83V	G											
5Y3	5AX4	G	No changes.									
	5AZ4	G										
	5T4	G										
	5U4	G										
	5V4	G										
	5W4	G										
	5Z4	G										
	5Y4	E		Same as 5T4 to 5Y4.								
	5Z3	G		Change socket to four prong and rewire as follows: <table border="0"> <tr> <td>No. 2 on octal</td> <td>to No. 1 on four prong</td> </tr> <tr> <td>4</td> <td>to 2</td> </tr> <tr> <td>6</td> <td>to 3</td> </tr> <tr> <td>8</td> <td>to 4</td> </tr> </table>	No. 2 on octal	to No. 1 on four prong	4	to 2	6	to 3	8	to 4
	No. 2 on octal	to No. 1 on four prong										
	4	to 2										
	6	to 3										
8	to 4											
80	E											
83	G											
83V	G											
5Y4	5T4	G	Same as 5X4 to 5T4.									
	5U4	G										
	5V4	G										
	5W4	E										
	5Y3	E										
	5X4	G		No changes.								
	5Z3	G		Same as 5X4 to 5Z3.								
	80	E										
	83	G										
	83V	G										
5Z3	5AX4	G	Same as 80 to 5U4.									
	5AZ4	G										
	5T4	G										
	5U4	E										
	5V4	G										
	5W4	G										
	5Z4	G										
	5X3	E		No changes.								
	80	G										
	83	G										
	83V	G										
	1275	G										
		5X4		E	Change four prong to octal socket and rewire as follows: <table border="0"> <tr> <td>No. 1 on four prong</td> <td>to No. 7 on octal</td> </tr> <tr> <td>2</td> <td>to 3</td> </tr> <tr> <td>3</td> <td>to 5</td> </tr> <tr> <td>4</td> <td>to 8</td> </tr> </table>	No. 1 on four prong	to No. 7 on octal	2	to 3	3	to 5	4
No. 1 on four prong	to No. 7 on octal											
2	to 3											
3	to 5											
4	to 8											

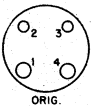
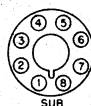
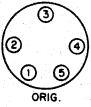

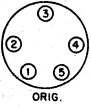
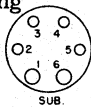





RECEIVING TUBE SUBSTITUTION GUIDE

TUBE	SUB.	PERF.	CIRCUIT CHANGES NECESSARY																
5Z4	5AX4	G	No changes.																
	5AZ4	G																	
	5T4	G																	
	5U4	G																	
	5V4	G																	
	5W4	G																	
	5Y3	G																	
	5Y4	G	Same as 5T4 to 5Y4.																
6A3	6A5	E	Same as 6A3 to 6B4. No. 8 is cathode and filament tap.																
	6B4	E	Change socket to octal and rewire as follows:  <table style="display: inline-table; vertical-align: middle;"> <tr> <td>No. 1 on four prong</td> <td>to No. 2 on octal</td> </tr> <tr> <td>2</td> <td>to 3</td> </tr> <tr> <td>3</td> <td>to 5</td> </tr> <tr> <td>4</td> <td>to 7</td> </tr> </table> 	No. 1 on four prong	to No. 2 on octal	2	to 3	3	to 5	4	to 7								
No. 1 on four prong	to No. 2 on octal																		
2	to 3																		
3	to 5																		
4	to 7																		
6A4	52	G	No changes.																
6A4/LA	6F6	G	Parallel circuits only. Change socket to octal and rewire as follows:  <table style="display: inline-table; vertical-align: middle;"> <tr> <td>No. 1 on five prong</td> <td>to No. 2 on octal</td> </tr> <tr> <td>2</td> <td>to 3</td> </tr> <tr> <td>3</td> <td>to 5</td> </tr> <tr> <td>4</td> <td>to 4</td> </tr> <tr> <td>5</td> <td>to 7 and 8</td> </tr> </table> 	No. 1 on five prong	to No. 2 on octal	2	to 3	3	to 5	4	to 4	5	to 7 and 8						
	No. 1 on five prong	to No. 2 on octal																	
	2	to 3																	
	3	to 5																	
	4	to 4																	
5	to 7 and 8																		
6G6	G																		
6K6	G																		
6U6	G																		
6V6	G																		
41	42	G	Parallel circuits only. Change socket to six prong and rewire as follows:  <table style="display: inline-table; vertical-align: middle;"> <tr> <td>No. 1 on five prong</td> <td>to No. 1 on six prong</td> </tr> <tr> <td>2</td> <td>to 2</td> </tr> <tr> <td>3</td> <td>to 4</td> </tr> <tr> <td>4</td> <td>to 3</td> </tr> <tr> <td>5</td> <td>to 5 and 6</td> </tr> </table> 	No. 1 on five prong	to No. 1 on six prong	2	to 2	3	to 4	4	to 3	5	to 5 and 6						
	No. 1 on five prong	to No. 1 on six prong																	
2	to 2																		
3	to 4																		
4	to 3																		
5	to 5 and 6																		
6A5	6A3	E	Reverse 6A3 to 6B4 procedure.																
	6B4	E	Connect a 20 ohm resistor from No. 2 to No. 8. Connect a 20 ohm resistor from No. 7 to No. 8.																
6A6	6E6	G	Parallel circuits only. No changes.																
	6N7	G	Reverse 6N7 to 6A6 procedure.																
	79	G	Reverse 79 to 6A6 procedure.																
6A7	6A8	E	Change socket to octal and rewire as follows: <table style="display: inline-table; vertical-align: middle;"> <tr> <td>No. 1 on seven prong</td> <td>to No. 2 on octal</td> </tr> <tr> <td>2</td> <td>to 3</td> </tr> <tr> <td>3</td> <td>to 4</td> </tr> <tr> <td>4</td> <td>to 6</td> </tr> <tr> <td>5</td> <td>to 5</td> </tr> <tr> <td>6</td> <td>to 8</td> </tr> <tr> <td>7</td> <td>to 7</td> </tr> <tr> <td>cap</td> <td>to cap</td> </tr> </table>  	No. 1 on seven prong	to No. 2 on octal	2	to 3	3	to 4	4	to 6	5	to 5	6	to 8	7	to 7	cap	to cap
	No. 1 on seven prong	to No. 2 on octal																	
	2	to 3																	
3	to 4																		
4	to 6																		
5	to 5																		
6	to 8																		
7	to 7																		
cap	to cap																		
6J8	E																		
6K8	E																		
	6D8	E	Same as 6A7 to 6A8. Parallel circuits only.																



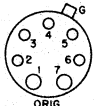

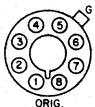
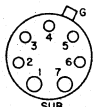

## RECEIVING TUBE SUBSTITUTION GUIDE

6A7-6AB4

TUBE	SUB.	PERF.	CIRCUIT CHANGES NECESSARY																
6A7	7A8 7B8 7J8 7S7	E E E E	<p>Change socket to loctal and rewire as follows:</p> <table style="margin-left: 40px;"> <tr> <td>No. 1 on seven prong</td> <td>to No. 1 on loctal</td> </tr> <tr> <td>2</td> <td>to 2</td> </tr> <tr> <td>3</td> <td>to 5</td> </tr> <tr> <td>4</td> <td>to 3</td> </tr> <tr> <td>5</td> <td>to 4</td> </tr> <tr> <td>6</td> <td>to 7</td> </tr> <tr> <td>7</td> <td>to 8</td> </tr> </table> <div style="display: flex; justify-content: space-around; align-items: center;">   </div>	No. 1 on seven prong	to No. 1 on loctal	2	to 2	3	to 5	4	to 3	5	to 4	6	to 7	7	to 8		
No. 1 on seven prong	to No. 1 on loctal																		
2	to 2																		
3	to 5																		
4	to 3																		
5	to 4																		
6	to 7																		
7	to 8																		
	7Q7	G	<p>Change socket to loctal and rewire as follows:</p> <table style="margin-left: 40px;"> <tr> <td>No. 1 on seven prong</td> <td>to No. 1 on loctal</td> </tr> <tr> <td>2</td> <td>to 2</td> </tr> <tr> <td>4</td> <td>to 3</td> </tr> <tr> <td>5</td> <td>to 4</td> </tr> <tr> <td>6</td> <td>to 7 and 5</td> </tr> <tr> <td>7</td> <td>to 8</td> </tr> <tr> <td>cap</td> <td>to 6</td> </tr> </table> <p style="margin-left: 40px;">Must be well shielded.</p> <div style="display: flex; justify-content: space-around; align-items: center;">   </div>	No. 1 on seven prong	to No. 1 on loctal	2	to 2	4	to 3	5	to 4	6	to 7 and 5	7	to 8	cap	to 6		
No. 1 on seven prong	to No. 1 on loctal																		
2	to 2																		
4	to 3																		
5	to 4																		
6	to 7 and 5																		
7	to 8																		
cap	to 6																		
6A8	6A7	E	<p>Change socket to seven prong and rewire as follows:</p> <table style="margin-left: 40px;"> <tr> <td>No. 2 on octal</td> <td>to No. 1 on seven prong</td> </tr> <tr> <td>3</td> <td>to 2</td> </tr> <tr> <td>4</td> <td>to 3</td> </tr> <tr> <td>5</td> <td>to 5</td> </tr> <tr> <td>6</td> <td>to 4</td> </tr> <tr> <td>7</td> <td>to 7</td> </tr> <tr> <td>8</td> <td>to 6</td> </tr> <tr> <td>cap</td> <td>to cap</td> </tr> </table> <div style="display: flex; justify-content: space-around; align-items: center;">   </div>	No. 2 on octal	to No. 1 on seven prong	3	to 2	4	to 3	5	to 5	6	to 4	7	to 7	8	to 6	cap	to cap
No. 2 on octal	to No. 1 on seven prong																		
3	to 2																		
4	to 3																		
5	to 5																		
6	to 4																		
7	to 7																		
8	to 6																		
cap	to cap																		
	6D8	E	Parallel circuits only. No changes.																
	6J8	E	No changes.																
	6K8	E	No changes.																
	7A8	G	Same as 6D8 to 7A8 but in parallel circuit only.																
	7B8	G	Same as 6D8 to 7A8																
	7J7	G	Same as 6J8 to 7J7																
	7Q7	G	<p>Change socket to loctal and rewire as follows:</p> <table style="margin-left: 40px;"> <tr> <td>No. 2 on octal</td> <td>to No. 1 on loctal</td> </tr> <tr> <td>3</td> <td>to 2</td> </tr> <tr> <td>5</td> <td>to 4</td> </tr> <tr> <td>6</td> <td>to 3</td> </tr> <tr> <td>7</td> <td>to 8</td> </tr> <tr> <td>8</td> <td>to 7 and 5</td> </tr> <tr> <td>cap</td> <td>to 6</td> </tr> </table> <p style="margin-left: 40px;">Must be well shielded. Realign if necessary.</p> <div style="display: flex; justify-content: space-around; align-items: center;">   </div>	No. 2 on octal	to No. 1 on loctal	3	to 2	5	to 4	6	to 3	7	to 8	8	to 7 and 5	cap	to 6		
No. 2 on octal	to No. 1 on loctal																		
3	to 2																		
5	to 4																		
6	to 3																		
7	to 8																		
8	to 7 and 5																		
cap	to 6																		
6AB4	6C4	G	Remove and tape up any wires anchored on No. 5.																
	6J4	P	<p>Parallel circuits only. Rewire as follows:</p> <table style="margin-left: 40px;"> <tr> <td>No. 7</td> <td>to No. 2</td> </tr> <tr> <td>1</td> <td>to 7</td> </tr> </table> <p style="margin-left: 40px;">Do not use blank connections on socket.</p>	No. 7	to No. 2	1	to 7												
No. 7	to No. 2																		
1	to 7																		

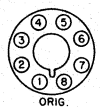
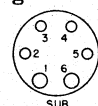



6AB4-6AC5G

RECEIVING TUBE SUBSTITUTION GUIDE

TUBE	SUB.	PERF.	CIRCUIT CHANGES NECESSARY																					
6AB4	6N4	P	Parallel circuits only. Rewire as follows:  Reverse No. 6 and No. 7 Connect No. 1 to No. 5 Remove and tape any wires connected to unused pins.																					
	9002	P	Rewire as follows:  Remove and tape up any wires anchored on pins No. 2 and No. 5																					
6AB5/6N5	6E5	P	Parallel circuits only. No changes.																					
	6U5/6G5	P	Parallel circuits only. No changes.																					
6AB6	6AC6	G	Parallel circuits only. No changes.																					
	6B5	G	Change socket to six prong and rewire as follows: <table border="0" style="margin-left: 40px;"> <tr> <td style="text-align: center;">No. 2 on octal</td> <td style="padding: 0 10px;">to</td> <td style="text-align: center;">No. 1 on six prong</td> </tr> <tr> <td style="text-align: center;">3</td> <td style="padding: 0 10px;">to</td> <td style="text-align: center;">2</td> </tr> <tr> <td style="text-align: center;">4</td> <td style="padding: 0 10px;">to</td> <td style="text-align: center;">3</td> </tr> <tr> <td style="text-align: center;">5</td> <td style="padding: 0 10px;">to</td> <td style="text-align: center;">4</td> </tr> <tr> <td style="text-align: center;">7</td> <td style="padding: 0 10px;">to</td> <td style="text-align: center;">6</td> </tr> <tr> <td style="text-align: center;">8</td> <td style="padding: 0 10px;">to</td> <td style="text-align: center;">5</td> </tr> </table> <div style="display: flex; justify-content: space-around; align-items: center; margin-top: 10px;">   </div>	No. 2 on octal	to	No. 1 on six prong	3	to	2	4	to	3	5	to	4	7	to	6	8	to	5			
No. 2 on octal	to	No. 1 on six prong																						
3	to	2																						
4	to	3																						
5	to	4																						
7	to	6																						
8	to	5																						
	6N6	G	No changes.																					
6AB7/1853	6AC7/1852	G	No changes.																					
	6AJ7	G	No changes.																					
	6SD7	G	Parallel circuits only. No changes.																					
	6SE7	G																						
	6SJ7	G																						
	6SK7	G																						
	6SS7	G																						
	5693	G																						
	7V7	G	Change socket to loctal and rewire as follows: <table border="0" style="margin-left: 40px;"> <tr> <td style="text-align: center;">No. 2 on octal</td> <td style="padding: 0 10px;">to</td> <td style="text-align: center;">No. 1 on loctal</td> </tr> <tr> <td style="text-align: center;">3</td> <td style="padding: 0 10px;">to</td> <td style="text-align: center;">4</td> </tr> <tr> <td style="text-align: center;">4</td> <td style="padding: 0 10px;">to</td> <td style="text-align: center;">6</td> </tr> <tr> <td style="text-align: center;">5</td> <td style="padding: 0 10px;">to</td> <td style="text-align: center;">7</td> </tr> <tr> <td style="text-align: center;">6</td> <td style="padding: 0 10px;">to</td> <td style="text-align: center;">3</td> </tr> <tr> <td style="text-align: center;">7</td> <td style="padding: 0 10px;">to</td> <td style="text-align: center;">8</td> </tr> <tr> <td style="text-align: center;">8</td> <td style="padding: 0 10px;">to</td> <td style="text-align: center;">2</td> </tr> </table> <div style="display: flex; justify-content: space-around; align-items: center; margin-top: 10px;">   </div>	No. 2 on octal	to	No. 1 on loctal	3	to	4	4	to	6	5	to	7	6	to	3	7	to	8	8	to	2
No. 2 on octal	to	No. 1 on loctal																						
3	to	4																						
4	to	6																						
5	to	7																						
6	to	3																						
7	to	8																						
8	to	2																						
	7W7	G	Change socket to loctal and rewire as follows: <table border="0" style="margin-left: 40px;"> <tr> <td style="text-align: center;">No. 2 on octal</td> <td style="padding: 0 10px;">to</td> <td style="text-align: center;">No. 1 on loctal</td> </tr> <tr> <td style="text-align: center;">3</td> <td style="padding: 0 10px;">to</td> <td style="text-align: center;">5</td> </tr> <tr> <td style="text-align: center;">4</td> <td style="padding: 0 10px;">to</td> <td style="text-align: center;">6</td> </tr> <tr> <td style="text-align: center;">5</td> <td style="padding: 0 10px;">to</td> <td style="text-align: center;">4 or 7</td> </tr> <tr> <td style="text-align: center;">6</td> <td style="padding: 0 10px;">to</td> <td style="text-align: center;">3</td> </tr> <tr> <td style="text-align: center;">7</td> <td style="padding: 0 10px;">to</td> <td style="text-align: center;">8</td> </tr> <tr> <td style="text-align: center;">8</td> <td style="padding: 0 10px;">to</td> <td style="text-align: center;">2</td> </tr> </table> <div style="display: flex; justify-content: space-around; align-items: center; margin-top: 10px;">   </div>	No. 2 on octal	to	No. 1 on loctal	3	to	5	4	to	6	5	to	4 or 7	6	to	3	7	to	8	8	to	2
No. 2 on octal	to	No. 1 on loctal																						
3	to	5																						
4	to	6																						
5	to	4 or 7																						
6	to	3																						
7	to	8																						
8	to	2																						
6AC5G	6AC5GT 6AC5GT/G	E E	No changes.																					

RECEIVING TUBE SUBSTITUTION GUIDE

6AC5GT-6AD6

TUBE	SUB.	PERF.	CIRCUIT CHANGES NECESSARY													
6AC5GT	6AC5G	E	No changes.													
	6AC5GT/G	E														
6AC6	6AB6	G	Parallel circuits only. No changes.													
6AC7	7W7	G	Same as 6AB7/1853 to 7W7.													
6AC7/1852	6AB7/1853	G	No changes.													
	6AH6	G	Change socket to miniature and rewire as follows: <table border="0" style="margin-left: 40px;"> <tr> <td style="text-align: center;">No. 2 on octal</td> <td style="text-align: center;">to No. 3 on miniature</td> </tr> <tr> <td style="text-align: center;">3</td> <td style="text-align: center;">to 2</td> </tr> <tr> <td style="text-align: center;">4</td> <td style="text-align: center;">to 1</td> </tr> <tr> <td style="text-align: center;">5</td> <td style="text-align: center;">to 7</td> </tr> <tr> <td style="text-align: center;">6</td> <td style="text-align: center;">to 6</td> </tr> <tr> <td style="text-align: center;">7</td> <td style="text-align: center;">to 4</td> </tr> <tr> <td style="text-align: center;">8</td> <td style="text-align: center;">to 5</td> </tr> </table>	No. 2 on octal	to No. 3 on miniature	3	to 2	4	to 1	5	to 7	6	to 6	7	to 4	8
No. 2 on octal	to No. 3 on miniature															
3	to 2															
4	to 1															
5	to 7															
6	to 6															
7	to 4															
8	to 5															
			 													
	6AJ7	G	No changes.													
	6SD7	G	Parallel circuits only. No changes.													
	6SE7	G														
	6SJ7	G														
	6SK7	G														
	6SS7	G														
	5693	G														
	7V7	G	Same as 6AB7/1853 to 7V7.													
6AD4	6K4	G	No changes.													
6AD5	6AE5	G	No changes.													
	6AF5	G														
	6C5	G														
	6J5	G														
	6P5	G														
	6F5	E	Rewire as follows:  Remove wires from No. 3 and connect to No. 4. Connect grid lead to No. 5. This pin may be used for anchor. Extend to grid cap.													
	6K5	G	Rewire as follows:  Connect terminal No. 5 to grid cap. This terminal may be used as an anchor.													
	7B4	G	Change socket to loctal and rewire as follows: <table border="0" style="margin-left: 40px;"> <tr> <td style="text-align: center;">No. 2 on octal</td> <td style="text-align: center;">to No. 1 on loctal</td> </tr> <tr> <td style="text-align: center;">3</td> <td style="text-align: center;">to 2</td> </tr> <tr> <td style="text-align: center;">5</td> <td style="text-align: center;">to 6</td> </tr> <tr> <td style="text-align: center;">7</td> <td style="text-align: center;">to 8</td> </tr> <tr> <td style="text-align: center;">8</td> <td style="text-align: center;">to 7</td> </tr> </table>	No. 2 on octal	to No. 1 on loctal	3	to 2	5	to 6	7	to 8	8	to 7			
No. 2 on octal	to No. 1 on loctal															
3	to 2															
5	to 6															
7	to 8															
8	to 7															
			 													
6AD6	6AF6	G	No changes.													

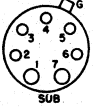

**6AD7-6AG6G**

**RECEIVING TUBE SUBSTITUTION GUIDE**

TUBE	SUB.	PERF.	CIRCUIT CHANGES NECESSARY																
6AD7	6F7	G	<p>Parallel circuits only. Change socket to seven prong and rewire as follows:</p> <table border="0"> <tr> <td>No. 1 on octal</td> <td>to No. 5 on seven prong</td> </tr> <tr> <td>2</td> <td>to 1</td> </tr> <tr> <td>3</td> <td>to 2</td> </tr> <tr> <td>4</td> <td>to 3</td> </tr> <tr> <td>5</td> <td>to cap</td> </tr> <tr> <td>6</td> <td>to 4</td> </tr> <tr> <td>7</td> <td>to 7</td> </tr> <tr> <td>8</td> <td>to 6</td> </tr> </table> <div style="display: flex; justify-content: space-around; align-items: center;">   </div>	No. 1 on octal	to No. 5 on seven prong	2	to 1	3	to 2	4	to 3	5	to cap	6	to 4	7	to 7	8	to 6
No. 1 on octal	to No. 5 on seven prong																		
2	to 1																		
3	to 2																		
4	to 3																		
5	to cap																		
6	to 4																		
7	to 7																		
8	to 6																		
	6P7	G	<p>Parallel circuits only. Remove wires from No. 5 and extend to grid cap. Rewire as follows:</p> <table border="0"> <tr> <td>No. 4</td> <td>to No. 5</td> </tr> <tr> <td>3</td> <td>to 4</td> </tr> <tr> <td>7</td> <td>to 3</td> </tr> <tr> <td>1</td> <td>to 7</td> </tr> </table>	No. 4	to No. 5	3	to 4	7	to 3	1	to 7								
No. 4	to No. 5																		
3	to 4																		
7	to 3																		
1	to 7																		
6AE5	6AD5 6AF5 6C5 6J5 6P5		No changes.																
6AE6	6AH7	G	<p>Parallel circuits only. Rewire as follows:</p> <p>Remove and tape up any wires on No. 1</p> <table border="0"> <tr> <td>No. 8</td> <td>to No. 4</td> </tr> <tr> <td>2</td> <td>to 8</td> </tr> <tr> <td>4</td> <td>to 6</td> </tr> </table> <p>Connect No. 4 and No. 2 together Connect No. 1 and No. 5 together</p>	No. 8	to No. 4	2	to 8	4	to 6										
No. 8	to No. 4																		
2	to 8																		
4	to 6																		
	6N7	P	<p>Parallel circuits only. Rewire as follows:</p> <table border="0"> <tr> <td>No. 4</td> <td>to No. 6</td> </tr> </table> <p>Connect No. 4 and No. 5 together.</p>	No. 4	to No. 6														
No. 4	to No. 6																		
6AF5	6AD5 6AE5 6C5 6J5 6P5	G G G G G	No changes.																
6AF6	6AD6	G	No changes.																
6AF7			No practical substitute.																
6AG5	6AJ5 6AK5 6AU6 6BC5 5590 5591 9001 9003	P G G G G G G G	<p>Parallel circuits only. No changes.</p> <p>Parallel circuits only. No changes.</p> <p>No changes.</p> <p>No changes.</p> <p>Parallel circuits only. No changes.</p>																
6AG6G			No practical substitute.																



## RECEIVING TUBE SUBSTITUTION GUIDE

6AG7-6AJ5

TUBE	SUB.	PERF.	CIRCUIT CHANGES NECESSARY
6AG7	6AK7	E	No changes.
6AH5	6AL6	G	Rewire as follows: <div style="margin-left: 100px;">                     No. 4                      to cap                            1                      to 4                            6                      to 5                 </div>
	6L6	G	Rewire as follows: <div style="margin-left: 100px;">                     No. 4                      to No. 3                            1                      to 4                            6                      to 5                 </div>
6AH6 *	6AJ5 6AK5	P P	Parallel circuits only. No changes.
	6AS6	P	Parallel circuits only. Rewire as follows: <div style="margin-left: 100px;">                     Reverse No. 2 and No. 7                 </div>
	6AU6	P	Parallel circuits only. No changes.
	6BC5	G	Parallel circuits only. No changes.
	6BD6	P	Parallel circuits only. No changes.
	EF50	P	Parallel circuits only. Reverse EF50 to 6BA6 procedure.
6AH7	6AE6	G	Parallel circuits only. Reverse 6AE6 to 6AH7 procedure.
	6C8	G	Rewire as follows: <div style="margin-left: 100px;">                     Connect wire from No. 1 to grid cap.                      Remove wires from No. 2                      No. 8                      to No. 2                            4                      to 8                      Connect wires removed from No. 2 to No. 4.                 </div>
	6SN7	P	Parallel circuits only. Rewire as follows: <div style="margin-left: 100px;">                     Reverse No. 2 and No. 3                      Remove wires from No. 4                      No. 5                      to No. 4                            6                      to 5                      Connect wires removed from No. 4 to No. 6.                 </div>
	7N7	P	Parallel circuits only. Change socket to loctal and rewire as follows: <div style="margin-left: 100px;">                     No. 1 on octal              to No. 4 on loctal                            2                      to 2                            3                      to 3                            4                      to 7                            5                      to 5                            6                      to 6                            7                      to 8                            8                      to 1                 </div>
			 
6AJ5	6AG5	P	Parallel circuits only. No changes.
	6AK5	P	No changes.
	6AU6	P	Parallel circuits only. No changes.



**6AJ7-6AM6**

**RECEIVING TUBE SUBSTITUTION GUIDE**

TUBE	SUB.	PERF.	CIRCUIT CHANGES NECESSARY												
6AJ7	6AB7/1853	G	No changes.												
	6AC7/1852	G													
	6SD7	G	Parallel circuits only. No changes.												
	6SE7	G													
	6SJ7	G													
	6SK7	G													
	6SS7	G													
	5693	G													
6AK5	6AG5	G	Parallel circuits only. No changes.												
	6AH6	G	Parallel circuits only. Connect No. 2 and No. 7 together.												
	6AJ5	P	No changes.												
	6AU6	P	Parallel circuits only. No changes.												
6AK6	6AR5	G	Parallel circuits only. Rewire as follows: Connect No. 2 and No. 7 together												
6AK7	6AG7	E	No changes.												
6AL5	6H6	G	Where space permits. Change socket to octal and rewire as follows: No. 1 on miniature to No. 8 on octal												
			<table border="0"> <tr> <td>2</td> <td>to</td> <td>3</td> </tr> <tr> <td>3</td> <td>to</td> <td>2</td> </tr> <tr> <td>4</td> <td>to</td> <td>7</td> </tr> <tr> <td>5</td> <td>to</td> <td>4</td> </tr> <tr> <td>7</td> <td>to</td> <td>5</td> </tr> </table>	2	to	3	3	to	2	4	to	7	5	to	4
2	to	3													
3	to	2													
4	to	7													
5	to	4													
7	to	5													
			 												
6AL6	6AH5	G	Reverse 6AH5 to 6AL6 procedure.												
	6L6	E	Rewire as follows: cap to No. 3												
6AL7			No practical substitute.												
6AM5	6AQ5	P	Parallel circuits only. No. 7 to No. 6												
	6AR5	P	Parallel circuits only. Rewire as follows: No. 7 to No. 6												
6AM6	6AH6	G	Parallel circuits only. Same as 6AM6 to 6AU6.												
	6AK6	G													

## RECEIVING TUBE SUBSTITUTION GUIDE

**6AM6-6AQ7**

TUBE	SUB.	PERF.	CIRCUIT CHANGES NECESSARY
6AM6	6AU6 6BA6 6BD6	G G G	Rewire as follows: Remove wires from No. 2 No. 6 to No. 2 7 to 6 Connect wires removed from No. 2 to No. 7.
6AN5	6AQ5	G	Rewire as follows: No. 7 to No. 2
6AN6			No practical substitute.
6AN7			No practical substitute.
6AQ5	6AM5	P	Parallel circuits only. Rewire as follows: No. 7 to No. 1 6 to 7
	6AN5	G	Parallel circuits only. Rewire as follows: No. 7 to No. 1
	6AR5	G	Rewire as follows: No. 7 to No. 1
	6AS5	G	Parallel circuits only. Reverse 6AS5 to 6AQ5 procedure.
	6BF5	P	Parallel circuits only. No changes.
	6V6	G	Where space permits. Change socket to octal and rewire as follows: No. 1 on miniature to No. 5 on octal 2 to 8 3 to 2 4 to 7 5 to 3 6 to 4 7 to 5
			 
6AQ6	6BD7	G	Parallel circuits only. Reverse 6BD7 to 6AQ6 procedure.
	6AT6 6AV6 6BF6 6BK6 6BT6 6BU6	G G G G G G	Parallel circuits only. No changes.
6AQ7	6AW7	G	Rewire as follows: Remove wires from No. 1 No. 2 to No. 1 4 to 2 Connect wires removed from No. 1 to No. 4. Remove wires from No. 3 No. 5 to No. 3 6 to 5 Connect wires removed from No. 3 to No. 6.

**6AR5-6AT6**

**RECEIVING TUBE SUBSTITUTION GUIDE**

TUBE	SUB.	PERF.	CIRCUIT CHANGES NECESSARY
6AR5	6AK6	G	Parallel circuits only. Rewire as follows: Connect No. 2 to No. 7 together.
	6AM5	P	Parallel circuits only. Rewire as follows: No. 6 to No. 7
	6AQ5	G	Parallel circuits only. No changes. Any wires connected to terminal No. 7 must be removed and taped up.
	6AS5	G	Parallel circuits only. Reverse 6AS5 to 6AR5 procedure.
6AR6	6F6	G	Parallel circuits only. Rewire as follows: No. 8 to No. 2 1 to 8 5 to 4 7 to 5 6 to 7
	6G6	G	
	6K6	G	
	6L6	G	
	6U6	G	
	6V6	G	
	6W6	G	
	6Y6 5824	G	
6AR7			No practical substitute.
6AS5	6AN5	G	Parallel circuits only. Rewire as follows: Reverse No. 1 and No. 2 5 to 1 7 to 5
	6AQ5	G	Parallel circuits only. Rewire as follows: Reverse No. 1 and No. 2 5 and 7
	6AR5	G	Parallel circuits only. Rewire as follows: Reverse No. 1 and No. 2 5 to 1 7 to 5
6AS6	6AH6	P	Parallel circuits only. Rewire as follows: Reverse No. 2 and No. 7
	6BH6	G	Parallel circuits only. No changes.
	6BJ6	G	
	6CB6	G	
6AS7G			No practical substitute.
6AT6	6AQ6	G	Parallel circuits only. No changes.



## RECEIVING TUBE SUBSTITUTION GUIDE

**6AT6-6AX6**

TUBE	SUB.	PERF.	CIRCUIT CHANGES NECESSARY
6AT6	6AV6	G	No changes.
	6BF6	G	
	6BK6	G	
	6BT6	G	
	6BU6	G	
	6BD7	G	Parallel circuits only. Reverse 6BD7 to 6AQ6 procedure.
6AU5	6AV5	G	Parallel circuits only. No changes.
	6BD5	G	
6AU6 *	6AG5	P	No changes.
	6AJ5	P	Parallel circuits only. No changes.
	6AK5	P	
	6BA6	G	No changes.
	6BH6	G	Parallel circuits only. Rewire as follows:  Reverse No. 2 and No. 7
6AV5	EF50	G	Reverse EF50 to 6BA6 procedure.
	6AU5	G	No changes.
	6BD5	G	
6AV6	6BQ6	G	Parallel circuits only. Reverse 6BQ6 to 6BD5 procedure.
	6AQ6	G	Parallel circuits only. No changes.
	6AT6	G	No changes.
6AW7	6AQ7	G	Reverse 6AQ7 to 6AW7 procedure.
6AX5	6AX6	E	Parallel circuits only. Tie Nos. 4 and 8 together.
	6BY5	E	Parallel circuits only. Rewire as follows:  Connect Nos. 1 and 8 together; also Nos. 3 and 4.
6AX6	6W5	G	Parallel circuits only. No changes.
	6X5	G	
	6ZY5	G	
	1274	G	
	6AX5	G	
	6W5	G	
	6X5	G	
	6ZY5	G	
	1274	G	

TUBE	SUB.	PERF.	CIRCUIT CHANGES NECESSARY														
6AX6	6BY5	E	Parallel circuits only. Rewire as follows: <table style="margin-left: 100px;"> <tr> <td>No. 4</td> <td>to No. 1</td> </tr> <tr> <td>3</td> <td>to 4</td> </tr> </table>	No. 4	to No. 1	3	to 4										
No. 4	to No. 1																
3	to 4																
6B4	6A3	G	Reverse 6A3 to 6B4 procedure.														
	6A5	E	No changes but remove any wires anchored on No. 8.														
6B5	6AB6	E	Same as 6B5 to 6N6. Parallel circuits only.														
	6N6	E	Change socket to octal and rewire as follows: <table style="margin-left: 100px;"> <tr> <td>No. 1 on six prong</td> <td>to No. 2 on octal</td> </tr> <tr> <td>2</td> <td>to 3</td> </tr> <tr> <td>3</td> <td>to 4</td> </tr> <tr> <td>4</td> <td>to 5</td> </tr> <tr> <td>5</td> <td>to 8</td> </tr> <tr> <td>6</td> <td>to 7</td> </tr> </table>	No. 1 on six prong	to No. 2 on octal	2	to 3	3	to 4	4	to 5	5	to 8	6	to 7		
No. 1 on six prong	to No. 2 on octal																
2	to 3																
3	to 4																
4	to 5																
5	to 8																
6	to 7																
	42	P	No changes.														
6B6	6Q7	E	No changes.														
	6SQ7	E	Make adaptor as follows: <table style="margin-left: 100px;"> <tr> <td>No. 1 on base</td> <td>to No. 1 on top</td> </tr> <tr> <td>2</td> <td>to 8</td> </tr> <tr> <td>3</td> <td>to 6</td> </tr> <tr> <td>4</td> <td>to 4</td> </tr> <tr> <td>5</td> <td>to 5</td> </tr> <tr> <td>7</td> <td>to 7</td> </tr> <tr> <td>8</td> <td>to 3</td> </tr> </table> <p style="margin-left: 100px;">Extend No. 2 on top to grid connection.</p>	No. 1 on base	to No. 1 on top	2	to 8	3	to 6	4	to 4	5	to 5	7	to 7	8	to 3
No. 1 on base	to No. 1 on top																
2	to 8																
3	to 6																
4	to 4																
5	to 5																
7	to 7																
8	to 3																
6T7		E	Parallel circuits only. No changes.														
7B6		G	Change socket to loctal and rewire as follows: <table style="margin-left: 100px;"> <tr> <td>No. 2 on octal</td> <td>to No. 1 on loctal</td> </tr> <tr> <td>3</td> <td>to 2</td> </tr> <tr> <td>4</td> <td>to 5</td> </tr> <tr> <td>5</td> <td>to 6</td> </tr> <tr> <td>7</td> <td>to 8</td> </tr> <tr> <td>8</td> <td>to 4 or 7</td> </tr> <tr> <td>cap</td> <td>to 3</td> </tr> </table>	No. 2 on octal	to No. 1 on loctal	3	to 2	4	to 5	5	to 6	7	to 8	8	to 4 or 7	cap	to 3
No. 2 on octal	to No. 1 on loctal																
3	to 2																
4	to 5																
5	to 6																
7	to 8																
8	to 4 or 7																
cap	to 3																
7C6		E	Same as 6B6 to 7B6. Parallel circuits only.														
75		E	Change socket to six prong and rewire as follows: <table style="margin-left: 100px;"> <tr> <td>No. 2 on octal</td> <td>to No. 1 on six prong</td> </tr> <tr> <td>3</td> <td>to 2</td> </tr> <tr> <td>4</td> <td>to 3</td> </tr> <tr> <td>5</td> <td>to 4</td> </tr> <tr> <td>7</td> <td>to 6</td> </tr> <tr> <td>8</td> <td>to 5</td> </tr> <tr> <td>cap</td> <td>to cap</td> </tr> </table>	No. 2 on octal	to No. 1 on six prong	3	to 2	4	to 3	5	to 4	7	to 6	8	to 5	cap	to cap
No. 2 on octal	to No. 1 on six prong																
3	to 2																
4	to 3																
5	to 4																
7	to 6																
8	to 5																
cap	to cap																
6B7	2B7	E	Heater voltage-current ratings differ.														

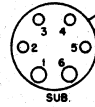
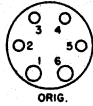

RECEIVING TUBE SUBSTITUTION GUIDE

6B7-6BC5

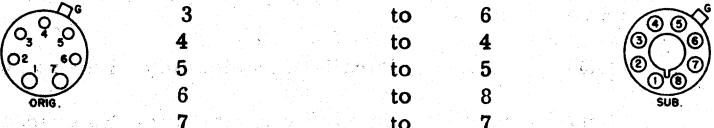
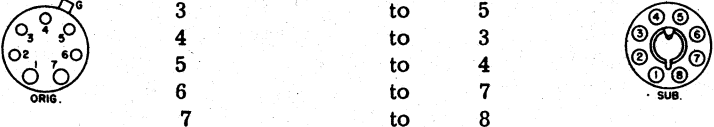
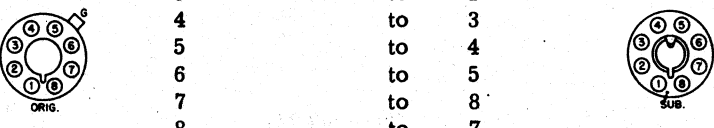
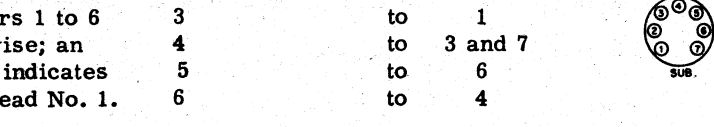
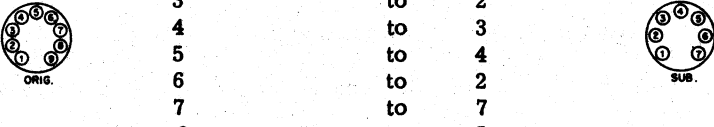
TUBE	SUB.	PERF.	CIRCUIT CHANGES NECESSARY																								
6B7	6B8	E	<p>Change socket to octal and rewire as follows:</p> <table border="0"> <tr> <td>No. 1 on seven prong</td> <td>to</td> <td>No. 2 on octal</td> </tr> <tr> <td>2</td> <td>to</td> <td>3</td> </tr> <tr> <td>3</td> <td>to</td> <td>6</td> </tr> <tr> <td>4</td> <td>to</td> <td>4</td> </tr> <tr> <td>5</td> <td>to</td> <td>5</td> </tr> <tr> <td>6</td> <td>to</td> <td>8</td> </tr> <tr> <td>7</td> <td>to</td> <td>7</td> </tr> <tr> <td>cap</td> <td>to</td> <td>cap</td> </tr> </table> 	No. 1 on seven prong	to	No. 2 on octal	2	to	3	3	to	6	4	to	4	5	to	5	6	to	8	7	to	7	cap	to	cap
No. 1 on seven prong	to	No. 2 on octal																									
2	to	3																									
3	to	6																									
4	to	4																									
5	to	5																									
6	to	8																									
7	to	7																									
cap	to	cap																									
	7E7	G	<p>Change socket to loctal and rewire as follows:</p> <table border="0"> <tr> <td>No. 1 on seven prong</td> <td>to</td> <td>No. 1 on loctal</td> </tr> <tr> <td>2</td> <td>to</td> <td>2</td> </tr> <tr> <td>3</td> <td>to</td> <td>5</td> </tr> <tr> <td>4</td> <td>to</td> <td>3</td> </tr> <tr> <td>5</td> <td>to</td> <td>4</td> </tr> <tr> <td>6</td> <td>to</td> <td>7</td> </tr> <tr> <td>7</td> <td>to</td> <td>8</td> </tr> <tr> <td>cap</td> <td>to</td> <td>6</td> </tr> </table> 	No. 1 on seven prong	to	No. 1 on loctal	2	to	2	3	to	5	4	to	3	5	to	4	6	to	7	7	to	8	cap	to	6
No. 1 on seven prong	to	No. 1 on loctal																									
2	to	2																									
3	to	5																									
4	to	3																									
5	to	4																									
6	to	7																									
7	to	8																									
cap	to	6																									
6B8	6B7	E	Reverse 6B7 to 6B8 procedure.																								
	7E7	G	<p>Change socket to loctal and rewire as follows:</p> <table border="0"> <tr> <td>No. 2 on octal</td> <td>to</td> <td>No. 1 on loctal</td> </tr> <tr> <td>3</td> <td>to</td> <td>2</td> </tr> <tr> <td>4</td> <td>to</td> <td>3</td> </tr> <tr> <td>5</td> <td>to</td> <td>4</td> </tr> <tr> <td>6</td> <td>to</td> <td>5</td> </tr> <tr> <td>7</td> <td>to</td> <td>8</td> </tr> <tr> <td>8</td> <td>to</td> <td>7</td> </tr> <tr> <td>cap</td> <td>to</td> <td>6</td> </tr> </table> 	No. 2 on octal	to	No. 1 on loctal	3	to	2	4	to	3	5	to	4	6	to	5	7	to	8	8	to	7	cap	to	6
No. 2 on octal	to	No. 1 on loctal																									
3	to	2																									
4	to	3																									
5	to	4																									
6	to	5																									
7	to	8																									
8	to	7																									
cap	to	6																									
6BA5	6BH6 6BJ6	P P	<p>Change to miniature and connect as follows:</p> <table border="0"> <tr> <td>No. 1 on 6BA5 base</td> <td>to</td> <td>No. 5 on miniature</td> </tr> <tr> <td>The 6BA5 base numbers 1 to 6 clockwise; an arrow indicates plate lead No. 1.</td> <td>2</td> <td>to 2</td> </tr> <tr> <td></td> <td>3</td> <td>to 1</td> </tr> <tr> <td></td> <td>4</td> <td>to 3 and 7</td> </tr> <tr> <td></td> <td>5</td> <td>to 6</td> </tr> <tr> <td></td> <td>6</td> <td>to 4</td> </tr> </table> 	No. 1 on 6BA5 base	to	No. 5 on miniature	The 6BA5 base numbers 1 to 6 clockwise; an arrow indicates plate lead No. 1.	2	to 2		3	to 1		4	to 3 and 7		5	to 6		6	to 4						
No. 1 on 6BA5 base	to	No. 5 on miniature																									
The 6BA5 base numbers 1 to 6 clockwise; an arrow indicates plate lead No. 1.	2	to 2																									
	3	to 1																									
	4	to 3 and 7																									
	5	to 6																									
	6	to 4																									
6BA6	6AU6 6BD6	G G	No changes.																								
	EF50	G	Reverse EF50 to 6BA6 procedure.																								
6BA7	6BE6	G	<p>Change socket to miniature and rewire as follows:</p> <table border="0"> <tr> <td>No. 1 on noval</td> <td>to</td> <td>No. 6 on miniature</td> </tr> <tr> <td>2</td> <td>to</td> <td>1</td> </tr> <tr> <td>3</td> <td>to</td> <td>2</td> </tr> <tr> <td>4</td> <td>to</td> <td>3</td> </tr> <tr> <td>5</td> <td>to</td> <td>4</td> </tr> <tr> <td>6</td> <td>to</td> <td>2</td> </tr> <tr> <td>7</td> <td>to</td> <td>7</td> </tr> <tr> <td>9</td> <td>to</td> <td>5</td> </tr> </table> 	No. 1 on noval	to	No. 6 on miniature	2	to	1	3	to	2	4	to	3	5	to	4	6	to	2	7	to	7	9	to	5
No. 1 on noval	to	No. 6 on miniature																									
2	to	1																									
3	to	2																									
4	to	3																									
5	to	4																									
6	to	2																									
7	to	7																									
9	to	5																									
6BC5	6AG5	P	No changes.																								
	6AJ5	P	Parallel circuits only. No changes.																								
	6AK5	P																									
	9001	P																									
	9003	P																									

**6BC7-6BJ6**

**RECEIVING TUBE SUBSTITUTION GUIDE**

TUBE	SUB.	PERF.	CIRCUIT CHANGES NECESSARY														
6BC7			No practical substitute.														
6BD5	6AU5	P	Parallel circuits only. No changes.														
	6AV5	P															
	6BQ6	G	Parallel circuits only. Reverse 6BQ6 to 6BD5 procedure.														
6BD6	6AH6	P	Parallel circuits only. No changes.														
	EF50	G	Reverse EF50 to 6BA6 procedure.														
6BD7	6AQ6	G	Parallel circuits only. Change socket to miniature and rewire as follows: <table border="0" style="margin-left: 40px;"> <tr> <td>No. 1 on noval</td> <td>to No. 7 on miniature</td> </tr> <tr> <td>2</td> <td>to 1</td> </tr> <tr> <td>3</td> <td>to 2</td> </tr> <tr> <td>4</td> <td>to 3</td> </tr> <tr> <td>5</td> <td>to 4</td> </tr> <tr> <td>6</td> <td>to 5</td> </tr> <tr> <td>8</td> <td>to 6</td> </tr> </table>	No. 1 on noval	to No. 7 on miniature	2	to 1	3	to 2	4	to 3	5	to 4	6	to 5	8	to 6
	No. 1 on noval	to No. 7 on miniature															
	2	to 1															
	3	to 2															
	4	to 3															
5	to 4																
6	to 5																
8	to 6																
6AT6	G																
6BF6	G																
6BT6	G																
6BU6	G																
6BE6	6BA7	G	Change socket to nine pin noval and rewire as follows: <table border="0" style="margin-left: 40px;"> <tr> <td>No. 1 on miniature</td> <td>to No. 2 on noval</td> </tr> <tr> <td>2</td> <td>to 3</td> </tr> <tr> <td>3</td> <td>to 4</td> </tr> <tr> <td>4</td> <td>to 5</td> </tr> <tr> <td>5</td> <td>to 9</td> </tr> <tr> <td>6</td> <td>to 1</td> </tr> <tr> <td>7</td> <td>to 7</td> </tr> </table>	No. 1 on miniature	to No. 2 on noval	2	to 3	3	to 4	4	to 5	5	to 9	6	to 1	7	to 7
	No. 1 on miniature	to No. 2 on noval															
2	to 3																
3	to 4																
4	to 5																
5	to 9																
6	to 1																
7	to 7																
	5915	G	No changes.														
6BF5	6AQ5	P	Parallel circuits only. No changes.														
	6AR5	P	Parallel circuits only. Short No. 7 to No. 1.														
6BF6	6BD7	G	Parallel circuits only. Reverse 6BD7 to 6AQ6 procedure.														
	6BU6	G	No changes.														
6BF7	6BG7	E															
6BG6	6BQ6	P	Parallel circuits only. Rewire as follows: <table border="0" style="margin-left: 40px;"> <tr> <td>No. 8</td> <td>to No. 4</td> </tr> <tr> <td>3</td> <td>to 8</td> </tr> </table>	No. 8	to No. 4	3	to 8										
	No. 8	to No. 4															
3	to 8																
	6CD6	P	Parallel circuits only. No changes. Sometimes it is necessary to increase wattage rating of screen resistor.														
6BG7	6BF7	E	No changes.														
6BH6	6BJ6	G	No changes.														
	6AS6	G	Parallel circuits only. No changes.														
	6BC5	P															
	6CB6	G															
6BJ6	6AS6	G	Parallel circuits only. No changes.														
	6BC5	P															
	6CB6	G															







RECEIVING TUBE SUBSTITUTION GUIDE

6BJ6-6C4

TUBE	SUB.	PERF.	CIRCUIT CHANGES NECESSARY
6BJ6	6BH6	G	No changes.
6BK6	6AT6	G	No changes.
	6AV6	G	
	6BF6	G	
	6BT6	G	
	6BU6	G	
6BN6			No practical substitute.
6BQ6	6AV5	G	Parallel circuits only. Rewire as follows:
	6BD5	G	
			No. 5 to No. 1 8 to 3 cap to 5 4 to 8
	6BG6	P	Parallel circuits only. Rewire as follows:
			No. 8 to No. 3 4 to 8
	6CD6	P	Where extra filament current is available. Parallel circuits only. Rewire as follows:
			No. 8 to No. 3 4 to 8
6BT6	6AQ6	G	Parallel circuits only. No changes.
	6BD7	G	Parallel circuits only. Reverse 6BD7 to 6AQ6 procedure.
	6BK6	G	No changes.
6BU6	6BD7	G	Parallel circuits only. Reverse 6BD7 to 6AQ6 procedure.
	6BF6	G	No changes.
6BY5	6AX5	G	Parallel circuits only. Where No. 1 and No. 8 are connected together, change connections as follows:
	6W5	G	
	6X5	G	
	6ZY5	G	
	1274	G	
6C4	6AB4	G	Rewire as follows:
			Connect No. 5 to No. 1
	6J4	P	Parallel circuits only. Rewire as follows:
			No. 7 to No. 2 1 to 7 5 to 7

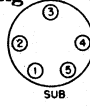

RECEIVING TUBE SUBSTITUTION GUIDE

TUBE	SUB.	PERF.	CIRCUIT CHANGES NECESSARY												
6C4	6AD5	P	Parallel circuits only. Where space permits, change socket to octal and rewire as follows: <table border="0"> <tr> <td>No. 1 on miniature</td> <td>to No. 3 on octal</td> </tr> <tr> <td>3</td> <td>to 2</td> </tr> <tr> <td>4</td> <td>to 7</td> </tr> <tr> <td>5</td> <td>to 3</td> </tr> <tr> <td>6</td> <td>to 5</td> </tr> <tr> <td>7</td> <td>to 8</td> </tr> </table>	No. 1 on miniature	to No. 3 on octal	3	to 2	4	to 7	5	to 3	6	to 5	7	to 8
	No. 1 on miniature	to No. 3 on octal													
	3	to 2													
	4	to 7													
	5	to 3													
	6	to 5													
7	to 8														
6AE5	P														
6AF5	P														
6C5	P														
6J5	P														
6P5	P														
			 												
6L5	P	Where space permits. Same as 6C4 to 6AD5.													
6N4	P	Parallel circuits only. Rewire as follows: <table border="0"> <tr> <td>No. 1</td> <td>to No. 5</td> </tr> <tr> <td>Reverse No. 6 and No. 7.</td> <td></td> </tr> </table>	No. 1	to No. 5	Reverse No. 6 and No. 7.										
No. 1	to No. 5														
Reverse No. 6 and No. 7.															
7A4	G	Parallel circuits only. Where space permits. Change socket to loctal and rewire as follows: <table border="0"> <tr> <td>No. 1 on miniature</td> <td>to No. 2 on loctal</td> </tr> <tr> <td>3</td> <td>to 1</td> </tr> <tr> <td>4</td> <td>to 8</td> </tr> <tr> <td>5</td> <td>to 2</td> </tr> <tr> <td>6</td> <td>to 6</td> </tr> <tr> <td>7</td> <td>to 7</td> </tr> </table>	No. 1 on miniature	to No. 2 on loctal	3	to 1	4	to 8	5	to 2	6	to 6	7	to 7	
	No. 1 on miniature		to No. 2 on loctal												
3	to 1														
4	to 8														
5	to 2														
6	to 6														
7	to 7														
7B4	P														
			 												
9002	P	No changes.													
6C5	6AD5	G	No changes.												
	6AE5	G													
	6AF5	G													
6C4	G	Reverse 6C4 to 6AD5 procedure.													
6F5	G	Make adaptor as follows: <table border="0"> <tr> <td>No. 1 on base</td> <td>to No. 1 on top</td> </tr> <tr> <td>2</td> <td>to 2</td> </tr> <tr> <td>3</td> <td>to 4</td> </tr> <tr> <td>5</td> <td>to cap</td> </tr> <tr> <td>7</td> <td>to 7</td> </tr> <tr> <td>8</td> <td>to 8</td> </tr> </table>	No. 1 on base	to No. 1 on top	2	to 2	3	to 4	5	to cap	7	to 7	8	to 8	
No. 1 on base	to No. 1 on top														
2	to 2														
3	to 4														
5	to cap														
7	to 7														
8	to 8														
6J5	G	No changes.													
6P5	G	No changes.													
7A4	G	Same as 6J5 to 7A4.													
7B4	G	Same as 6J5 to 7A4													
37	G	Change socket to five prong and rewire as follows: <table border="0"> <tr> <td>No. 2 on octal</td> <td>to No. 1 on five prong</td> </tr> <tr> <td>3</td> <td>to 2</td> </tr> <tr> <td>5</td> <td>to 3</td> </tr> <tr> <td>7</td> <td>to 5</td> </tr> <tr> <td>8</td> <td>to 4</td> </tr> </table>	No. 2 on octal	to No. 1 on five prong	3	to 2	5	to 3	7	to 5	8	to 4			
No. 2 on octal	to No. 1 on five prong														
3	to 2														
5	to 3														
7	to 5														
8	to 4														
76	G														
			 												
6C6*	6D6	G	No changes.												

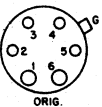
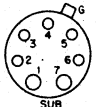
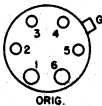
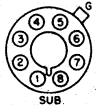
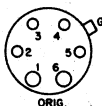
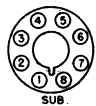
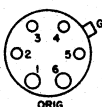

\* See Addendum at back of this section.

RECEIVING TUBE SUBSTITUTION GUIDE

6C6-6C8

TUBE	SUB.	PERF.	CIRCUIT CHANGES NECESSARY														
6C6	6D7	G	Change socket to seven prong and rewire as follows: <table border="0"> <tr> <td>No. 1 on six prong</td> <td>to No. 1 on seven prong</td> </tr> <tr> <td>2</td> <td>to 2</td> </tr> <tr> <td>3</td> <td>to 3</td> </tr> <tr> <td>4</td> <td>to 4</td> </tr> <tr> <td>5</td> <td>to 6</td> </tr> <tr> <td>6</td> <td>to 7</td> </tr> <tr> <td>cap</td> <td>to cap</td> </tr> </table>	No. 1 on six prong	to No. 1 on seven prong	2	to 2	3	to 3	4	to 4	5	to 6	6	to 7	cap	to cap
	No. 1 on six prong	to No. 1 on seven prong															
2	to 2																
3	to 3																
4	to 4																
5	to 6																
6	to 7																
cap	to cap																
	6E7	G															
			 														
	6J7	E	Change socket to octal and rewire as follows: <table border="0"> <tr> <td>No. 1 on six prong</td> <td>to No. 2 on octal</td> </tr> <tr> <td>2</td> <td>to 3</td> </tr> <tr> <td>3</td> <td>to 4</td> </tr> <tr> <td>4</td> <td>to 5</td> </tr> <tr> <td>5</td> <td>to 8</td> </tr> <tr> <td>6</td> <td>to 7</td> </tr> <tr> <td>cap</td> <td>to cap</td> </tr> </table>	No. 1 on six prong	to No. 2 on octal	2	to 3	3	to 4	4	to 5	5	to 8	6	to 7	cap	to cap
	No. 1 on six prong	to No. 2 on octal															
2	to 3																
3	to 4																
4	to 5																
5	to 8																
6	to 7																
cap	to cap																
	6K7	G															
	6U7	G															
			 														
	6S7	G	Same as 6C6 to 6J7. Parallel circuits only.														
	6SJ7	E	Change socket to octal and rewire as follows: <table border="0"> <tr> <td>No. 1 on six prong</td> <td>to No. 2 on octal</td> </tr> <tr> <td>2</td> <td>to 8</td> </tr> <tr> <td>3</td> <td>to 6</td> </tr> <tr> <td>4</td> <td>to 3</td> </tr> <tr> <td>5</td> <td>to 5</td> </tr> <tr> <td>6</td> <td>to 7</td> </tr> <tr> <td>cap</td> <td>to 4</td> </tr> </table>	No. 1 on six prong	to No. 2 on octal	2	to 8	3	to 6	4	to 3	5	to 5	6	to 7	cap	to 4
	No. 1 on six prong	to No. 2 on octal															
2	to 8																
3	to 6																
4	to 3																
5	to 5																
6	to 7																
cap	to 4																
	6SK7	G															
			 														
	6W7	G	Same as 6C6 to 6J7. Parallel circuits only.														
	7A7	G	Change socket to loctal and rewire as follows: <table border="0"> <tr> <td>No. 1 on six prong</td> <td>to No. 1 on loctal</td> </tr> <tr> <td>2</td> <td>to 2</td> </tr> <tr> <td>3</td> <td>to 3</td> </tr> <tr> <td>4</td> <td>to 4</td> </tr> <tr> <td>5</td> <td>to 7</td> </tr> <tr> <td>6</td> <td>to 8</td> </tr> <tr> <td>cap</td> <td>to 6</td> </tr> </table>	No. 1 on six prong	to No. 1 on loctal	2	to 2	3	to 3	4	to 4	5	to 7	6	to 8	cap	to 6
No. 1 on six prong	to No. 1 on loctal																
2	to 2																
3	to 3																
4	to 4																
5	to 7																
6	to 8																
cap	to 6																
			 														
	7B7	G	Same as 6C6 to 7A7. Parallel circuits only.														
	7C7	G															
	77	E	No changes.														
	78	E															
	1221	E															
6C7	6Q7	G	Make adaptor as follows: <table border="0"> <tr> <td>No. 1 on base</td> <td>to No. 2 on top</td> </tr> <tr> <td>2</td> <td>to 3</td> </tr> <tr> <td>4</td> <td>to 4</td> </tr> <tr> <td>5</td> <td>to 5</td> </tr> <tr> <td>6</td> <td>to 8</td> </tr> <tr> <td>7</td> <td>to 7</td> </tr> </table>	No. 1 on base	to No. 2 on top	2	to 3	4	to 4	5	to 5	6	to 8	7	to 7		
	No. 1 on base	to No. 2 on top															
2	to 3																
4	to 4																
5	to 5																
6	to 8																
7	to 7																
	6R7	G															
	6T7	G	Same as 6C7 to 6Q7. Parallel circuits only.														
6C8	6F8	G	Parallel circuits only. No changes.														



RECEIVING TUBE SUBSTITUTION GUIDE

TUBE	SUB.	PERF.	CIRCUIT CHANGES NECESSARY																
6C8	7F7	G	<p>Change socket to loctal and rewire as follows:</p> <table border="0"> <tr> <td>No. 2 on octal</td> <td>to No. 1 on loctal</td> </tr> <tr> <td>3</td> <td>to 3</td> </tr> <tr> <td>4</td> <td>to 2</td> </tr> <tr> <td>5</td> <td>to 5</td> </tr> <tr> <td>6</td> <td>to 6</td> </tr> <tr> <td>7</td> <td>to 8</td> </tr> <tr> <td>8</td> <td>to 7</td> </tr> <tr> <td>cap</td> <td>to 4</td> </tr> </table> <div style="display: flex; justify-content: space-around; align-items: center;">   </div>	No. 2 on octal	to No. 1 on loctal	3	to 3	4	to 2	5	to 5	6	to 6	7	to 8	8	to 7	cap	to 4
No. 2 on octal	to No. 1 on loctal																		
3	to 3																		
4	to 2																		
5	to 5																		
6	to 6																		
7	to 8																		
8	to 7																		
cap	to 4																		
6CB6	6AS6 6BH6 6BJ6	P P P	Parallel circuits only. No changes.																
6CD6	6BG6 6BQ6	G P	<p>Parallel circuits only. No changes.</p> <p>Parallel circuits only. Rewire as follows:</p> <table border="0"> <tr> <td>No. 8</td> <td>to No. 4</td> </tr> <tr> <td>3</td> <td>to 8</td> </tr> </table>	No. 8	to No. 4	3	to 8												
No. 8	to No. 4																		
3	to 8																		
6D4			No practical substitute.																
6D6	6C6 6D7 6E7 6J7 6K7 6S7 6SJ7 6SK7 6U7 6W7 7A7 7B7 7C7 39/44 77 78	G G G G E G G E G G E G G G G G G E	<p>No changes.</p> <p>Same as 6C6 to 6D7.</p> <p>Same as 6C6 to 6D7.</p> <p>Same as 6C6 to 6J7.</p> <p>Same as 6C6 to 6J7. Parallel circuits only.</p> <p>Same as 6C6 to 6SJ7.</p> <p>Same as 6C6 to 6J7.</p> <p>Same as 6C6 to 6J7. Parallel circuits only.</p> <p>Same as 6C6 to 7A7.</p> <p>Same as 6C6 to 7A7. Parallel circuits only.</p> <p>Same as 78 to 39/44.</p> <p>No changes.</p>																
6D7	6E7	G	No changes.																
6D8	6A7 6A8 6J8 6K8	G G G G	<p>Parallel circuits only. Reverse 6A7 to 6A8 procedure.</p> <p>Parallel circuits only. No changes.</p>																









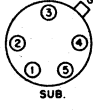

RECEIVING TUBE SUBSTITUTION GUIDE

6D8-6F5

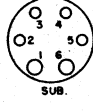
TUBE	SUB.	PERF.	CIRCUIT CHANGES NECESSARY																
6D8	7A8	G	Change socket to loctal and rewire as follows: <table border="0"> <tr> <td>No. 2 on octal</td> <td>to No. 1 on loctal</td> </tr> <tr> <td>3</td> <td>to 2</td> </tr> <tr> <td>4</td> <td>to 5</td> </tr> <tr> <td>5</td> <td>to 4</td> </tr> <tr> <td>6</td> <td>to 3</td> </tr> <tr> <td>7</td> <td>to 8</td> </tr> <tr> <td>8</td> <td>to 7</td> </tr> <tr> <td>cap</td> <td>to 6</td> </tr> </table> <div style="display: flex; justify-content: space-around; align-items: center;">   </div>	No. 2 on octal	to No. 1 on loctal	3	to 2	4	to 5	5	to 4	6	to 3	7	to 8	8	to 7	cap	to 6
No. 2 on octal	to No. 1 on loctal																		
3	to 2																		
4	to 5																		
5	to 4																		
6	to 3																		
7	to 8																		
8	to 7																		
cap	to 6																		
	7B8	G	Same as 6D8 to 7A8. Parallel circuits only.																
	7J7	G																	
	7S7	G																	
	7Q7	G	Same as 6A8 to 7Q7. Parallel circuits only.																
	12A8	P	Series circuits only. No changes.																
	12K8	P																	
6E5	2E5	E	Heater voltage - current ratings differ.																
	6AB5/6N5	P	Parallel circuits only. No changes.																
	6T5	E	No changes.																
	6U5/6G5	E																	
6E6	6A6	G	Parallel circuits only. No changes.																
6E7	6D7	G	No changes.																
6E8			No practical substitute.																
6F4	6L4	P	No changes.																
6F5	6AD5	G	Make adaptor as follows: <table border="0"> <tr> <td>No. 1 on base</td> <td>to No. 1 on socket</td> </tr> <tr> <td>2</td> <td>to 2</td> </tr> <tr> <td>4</td> <td>to 3</td> </tr> <tr> <td>7</td> <td>to 7</td> </tr> <tr> <td>8</td> <td>to 8</td> </tr> <tr> <td>Connect grid cap</td> <td>to 5 on base.</td> </tr> </table>	No. 1 on base	to No. 1 on socket	2	to 2	4	to 3	7	to 7	8	to 8	Connect grid cap	to 5 on base.				
No. 1 on base	to No. 1 on socket																		
2	to 2																		
4	to 3																		
7	to 7																		
8	to 8																		
Connect grid cap	to 5 on base.																		
	6C5	G	Reverse 6C5 to 6F5 procedure.																
	6J5	G																	
	6K5	E	Change connections as follows: <table border="0"> <tr> <td>No. 4</td> <td>to No. 3</td> </tr> </table>	No. 4	to No. 3														
No. 4	to No. 3																		
	6SF5	E	Make adaptor as follows: <table border="0"> <tr> <td>No. 1 on base</td> <td>to No. 1 on top</td> </tr> <tr> <td>2</td> <td>to 8</td> </tr> <tr> <td>4</td> <td>to 5</td> </tr> <tr> <td>7</td> <td>to 7</td> </tr> <tr> <td>8</td> <td>to 2</td> </tr> <tr> <td>cap</td> <td>to 3</td> </tr> </table>	No. 1 on base	to No. 1 on top	2	to 8	4	to 5	7	to 7	8	to 2	cap	to 3				
No. 1 on base	to No. 1 on top																		
2	to 8																		
4	to 5																		
7	to 7																		
8	to 2																		
cap	to 3																		

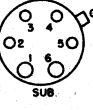
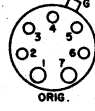
RECEIVING TUBE SUBSTITUTION GUIDE

TUBE	SUB.	PERF.	CIRCUIT CHANGES NECESSARY													
6F5	7A4	G	Change socket to loctal and rewire as follows: <table border="0"> <tr> <td>No. 2 on octal</td> <td>to No. 1 on loctal</td> </tr> <tr> <td>4</td> <td>to 2</td> </tr> <tr> <td>7</td> <td>to 8</td> </tr> <tr> <td>8</td> <td>to 7</td> </tr> <tr> <td>cap</td> <td>to 6</td> </tr> </table>	No. 2 on octal	to No. 1 on loctal	4	to 2	7	to 8	8	to 7	cap	to 6			
	No. 2 on octal	to No. 1 on loctal														
4	to 2															
7	to 8															
8	to 7															
cap	to 6															
	7B4	G														
			 													
6F6*	6A4/LA	P	Parallel circuits only. Reverse 6A4/LA to 6F6 procedure.													
	6AD7	G	Parallel circuits only. Remove and tape up any wires on Nos. 1 and 6.													
	6AR6	G	Where additional filament current is available. Reverse 6AR6 to 6F6 procedure.													
	6G6	P	Parallel circuits only. No changes.													
	6K6	G														
	6L6	G														
	6U6	G														
	6V6	G														
	7B5	G	Same as 6K6 to 7B5.													
	7C5	G														
38	G	Parallel circuits only. Change socket to five prong and rewire as follows:	<table border="0"> <tr> <td>No. 2 on octal</td> <td>to No. 1 on five prong</td> </tr> <tr> <td>3</td> <td>to 2</td> </tr> <tr> <td>4</td> <td>to 3</td> </tr> <tr> <td>5</td> <td>to cap</td> </tr> <tr> <td>7</td> <td>to 5</td> </tr> <tr> <td>8</td> <td>to 4</td> </tr> </table>	No. 2 on octal	to No. 1 on five prong	3	to 2	4	to 3	5	to cap	7	to 5	8	to 4	
			No. 2 on octal	to No. 1 on five prong												
3	to 2															
4	to 3															
5	to cap															
7	to 5															
8	to 4															
		 														
41	G	Same as 6F6 to 42. Parallel circuits only.														
42	E	Change socket to six prong and rewire as follows:	<table border="0"> <tr> <td>No. 2 on octal</td> <td>to No. 1 on six prong</td> </tr> <tr> <td>3</td> <td>to 2</td> </tr> <tr> <td>4</td> <td>to 3</td> </tr> <tr> <td>5</td> <td>to 4</td> </tr> <tr> <td>7</td> <td>to 6</td> </tr> <tr> <td>8</td> <td>to 5</td> </tr> </table>	No. 2 on octal	to No. 1 on six prong	3	to 2	4	to 3	5	to 4	7	to 6	8	to 5	
			No. 2 on octal	to No. 1 on six prong												
3	to 2															
4	to 3															
5	to 4															
7	to 6															
8	to 5															
		 														
89	G	Parallel circuits only. Change socket to six prong and rewire as follows:	<table border="0"> <tr> <td>No. 2 on octal</td> <td>to No. 1 on six prong</td> </tr> <tr> <td>3</td> <td>to 2</td> </tr> <tr> <td>4</td> <td>to 3</td> </tr> <tr> <td>5</td> <td>to cap</td> </tr> <tr> <td>7</td> <td>to 6</td> </tr> <tr> <td>8</td> <td>to 5</td> </tr> </table>	No. 2 on octal	to No. 1 on six prong	3	to 2	4	to 3	5	to cap	7	to 6	8	to 5	
			No. 2 on octal	to No. 1 on six prong												
3	to 2															
4	to 3															
5	to cap															
7	to 6															
8	to 5															
		  <p>short 4 and 5 together.</p>														
6F7	6P7	E	Change socket to octal and rewire as follows:													
			<table border="0"> <tr> <td>No. 1 on seven prong</td> <td>to No. 2 on octal</td> </tr> <tr> <td>2</td> <td>to 4</td> </tr> <tr> <td>3</td> <td>to 5</td> </tr> <tr> <td>4</td> <td>to 6</td> </tr> <tr> <td>5</td> <td>to 7</td> </tr> <tr> <td>6</td> <td>to 8</td> </tr> <tr> <td>7</td> <td>to 3</td> </tr> <tr> <td>cap</td> <td>to cap</td> </tr> </table>	No. 1 on seven prong	to No. 2 on octal	2	to 4	3	to 5	4	to 6	5	to 7	6	to 8	7
No. 1 on seven prong	to No. 2 on octal															
2	to 4															
3	to 5															
4	to 6															
5	to 7															
6	to 8															
7	to 3															
cap	to cap															
			 													
6F8	6C8	G	Parallel circuits only. No changes.													

\* See Addendum at back of this section.

RECEIVING TUBE SUBSTITUTION GUIDE

6G5-6J4

TUBE	SUB.	PERF.	CIRCUIT CHANGES NECESSARY
6G5	6AB5	G	Parallel circuits only. No changes.
	6E5	G	No changes.
	6T5	G	
	6U5	G	
6G6	6A4/LA	G	Parallel circuits only. Reverse 6A4/LA to 6F6 procedure.
	6F6	G	Parallel circuits only. No changes.
	6K6	G	
	6V6	G	
	12A6	P	Series circuits only. No changes.
	41	G	Same as 6F6 to 42. Parallel circuits only.
	42	G	
6H4	6H6	G	Parallel circuits only. Rewire as follows:  No. 4 to No. 3 Connect No. 3 and No. 5 together. Connect No. 4 and No. 8 together.
6H5	6U5/6G5	E	No changes.
6H6	6AL5	G	Same as 12H6 to 12AL5.
	6W5	P	Parallel circuits only. Tie Nos. 4 and 8 together.
	6X5	P	
	6ZY5	P	Tie Nos. 4 and 8 together.
7A6	E	P	Parallel circuits only. Change socket to loctal and rewire as follows: No. 1 on octal to No. 5 on loctal 2 to 1 3 to 3 4 to 2 5 to 6 7 to 8 8 to 7
7Y4	7Z4	P	Parallel circuits only. Change socket to loctal and rewire as follows: No. 2 on octal to No. 1 on loctal 3 to 3 4 and 8 to 7 5 to 6 7 to 8 8 to 7
6H8			No practical substitute.
6J4	6AB4	P	Parallel circuits only. Rewire as follows:  Nos. 1 and 5 to 6 7 to 1 2 to 7



**6J4-6J7**



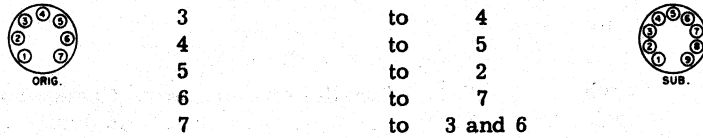



**RECEIVING TUBE SUBSTITUTION GUIDE**

TUBE	SUB.	PERF.	CIRCUIT CHANGES NECESSARY
6J4	6C4	G	Parallel circuits only. Reverse 6C4 to 6J4 procedure.
	6N4	G	Parallel circuits only. Rewire as follows: Reverse Nos. 5 and 7 No. 6 to No. 7
	9002	G	Parallel circuits only. Rewire as follows: Nos. 1 and 5 to No. 6 7 to 1
6J5	6AD5	G	No changes.
	6AE5	G	
	6AF5	G	
	6C5	G	
	6F5	G	Same as 6C5 to 6F5.
	6K5	G	Change connections as follows: No. 5 to cap.
	6L5	G	Parallel circuits only. No changes.
	6P5	G	No changes.
	7A4 XXL	E E	Change socket to loctal and rewire as follows: No. 2 on octal to No. 1 on loctal 3 to 2 5 to 6 7 to 8 8 to 7
	37 76	G G	Same as 6C5 to 37.
6J6	5687	P	Parallel circuits only. Change socket to noval and rewire as follows: No. 1 on miniature to No. 9 on noval 2 to 1 3 to 4 4 to 5 5 to 2 6 to 7 7 to 3 and 6
			
6J7*	6C6	E	Reverse 6C6 to 6J7 procedure.
	6D6	E	
	6D7	G	Change socket to seven prong and rewire as follows: No. 2 on octal to No. 1 on seven prong 3 to 2 4 to 3 5 to 4 7 to 7 8 to 6 cap to cap
	6E7	G	
	6K7	G	No changes.
6S7	G	Parallel circuits only. No changes.	





\* See Addendum at back of this section.

# RECEIVING TUBE SUBSTITUTION GUIDE

6J7-6J8





TUBE	SUB.	PERF.	CIRCUIT CHANGES NECESSARY																	
6J7	6SH7	G	Make adaptor as follows: <table style="margin-left: 100px; border: none;"> <tr> <td style="padding-right: 20px;">No. 1 on base</td> <td style="padding-right: 20px;">to No. 1 on top</td> </tr> <tr> <td>2</td> <td>to 2</td> </tr> <tr> <td>3</td> <td>to 8</td> </tr> <tr> <td>4</td> <td>to 6</td> </tr> <tr> <td>5</td> <td>to 3</td> </tr> <tr> <td>7</td> <td>to 7</td> </tr> <tr> <td>8</td> <td>to 5</td> </tr> <tr> <td>cap</td> <td>to 4</td> </tr> </table>	No. 1 on base	to No. 1 on top	2	to 2	3	to 8	4	to 6	5	to 3	7	to 7	8	to 5	cap	to 4	
	No. 1 on base	to No. 1 on top																		
	2	to 2																		
	3	to 8																		
	4	to 6																		
	5	to 3																		
	7	to 7																		
	8	to 5																		
	cap	to 4																		
	6SJ7	E																		
	6SK7	G																		
	6U7	G		No changes.																
	6W7	G		Parallel circuits only. No changes.																
	7A7	G		Change socket to loctal and rewire as follows: <table style="margin-left: 100px; border: none;"> <tr> <td style="padding-right: 20px;">No. 1 on octal</td> <td style="padding-right: 20px;">to No. 5 on loctal</td> </tr> <tr> <td>2</td> <td>to 1</td> </tr> <tr> <td>3</td> <td>to 2</td> </tr> <tr> <td>4</td> <td>to 3</td> </tr> <tr> <td>5</td> <td>to 4</td> </tr> <tr> <td>7</td> <td>to 8</td> </tr> <tr> <td>8</td> <td>to 7</td> </tr> <tr> <td>cap</td> <td>to 6</td> </tr> </table>	No. 1 on octal	to No. 5 on loctal	2	to 1	3	to 2	4	to 3	5	to 4	7	to 8	8	to 7	cap	to 6
	No. 1 on octal	to No. 5 on loctal																		
	2	to 1																		
	3	to 2																		
	4	to 3																		
	5	to 4																		
	7	to 8																		
8	to 7																			
cap	to 6																			
7H7	G																			
7L7	G																			
<table style="width: 100%; border: none;"> <tr> <td style="text-align: center; width: 45%;">  </td> <td style="text-align: center; width: 10%;"></td> <td style="text-align: center; width: 45%;">  </td> </tr> </table>																				
																				
7B7	G	Same as 6J7 to 7L7. Parallel circuits only.																		
7C7	G																			
7G7	G	Same as 6J7 to 6L7.																		
.39/44	G	Same as 6K7 to 39/44.																		
36	G																			
77	E	Reverse 6C6 to 6J7 procedure.																		
78	G																			
1221	E	Reverse 6C6 to 6J7 procedure.																		
1223	E	No changes.																		
1232	E	Same as 6J7 to 6L7.																		
1620	E	No changes.																		
6J8	6A7	G	Same as 6A8 to 6A7.																	
	6A8	G	No changes.																	
	6D8	G	Parallel circuits only. No changes.																	
	6K8	G	No changes.																	
	7A8	G	Same as 6D8 to 7A8. Parallel circuits only.																	
	7B8	G																		

RECEIVING TUBE SUBSTITUTION GUIDE

TUBE	SUB.	PERF.	CIRCUIT CHANGES NECESSARY																
6J8	7J7	G	Change socket to loctal and rewire as follows: <table border="0"> <tr> <td>No. 2 on octal</td> <td>to No. 1 on loctal</td> </tr> <tr> <td>3</td> <td>to 2</td> </tr> <tr> <td>4</td> <td>to 5</td> </tr> <tr> <td>5</td> <td>to 4</td> </tr> <tr> <td>6</td> <td>to 3</td> </tr> <tr> <td>7</td> <td>to 8</td> </tr> <tr> <td>8</td> <td>to 7</td> </tr> <tr> <td>cap</td> <td>to 6</td> </tr> </table>	No. 2 on octal	to No. 1 on loctal	3	to 2	4	to 5	5	to 4	6	to 3	7	to 8	8	to 7	cap	to 6
	No. 2 on octal	to No. 1 on loctal																	
3	to 2																		
4	to 5																		
5	to 4																		
6	to 3																		
7	to 8																		
8	to 7																		
cap	to 6																		
	7S7	G																	
			 																
	7Q7	G	Same as 6A8 to 7Q7.																
6K4	6AD4	E	No changes.																
6K5	6AD5	G	Make adaptor as follows: <table border="0"> <tr> <td>No. 2 on base</td> <td>to No. 2 on cap</td> </tr> <tr> <td>3</td> <td>to 3</td> </tr> <tr> <td>7</td> <td>to 7</td> </tr> <tr> <td>8</td> <td>to 8</td> </tr> </table>	No. 2 on base	to No. 2 on cap	3	to 3	7	to 7	8	to 8								
			No. 2 on base	to No. 2 on cap															
3	to 3																		
7	to 7																		
8	to 8																		
			Connect grid cap to No. 5 on base. This substitution can also be made by merely connecting the grid cap to No. 5 on the socket.																
	6AE5	G	Change connection as follows: cap to No. 5.																
	6C5	G																	
	6J5	G																	
	6F5	G	Change connections as follows: <table border="0"> <tr> <td>No. 3</td> <td>to No. 4</td> </tr> </table>	No. 3	to No. 4														
No. 3	to No. 4																		
	6Q7	G	Cut off pins Nos. 4 and 5.																
	6SF5	G	Make adaptor as follows: <table border="0"> <tr> <td>No. 1 on base</td> <td>to No. 1 on top</td> </tr> <tr> <td>2</td> <td>to 8</td> </tr> <tr> <td>3</td> <td>to 5</td> </tr> <tr> <td>7</td> <td>to 7</td> </tr> <tr> <td>8</td> <td>to 2</td> </tr> <tr> <td>cap</td> <td>to 3</td> </tr> </table>	No. 1 on base	to No. 1 on top	2	to 8	3	to 5	7	to 7	8	to 2	cap	to 3				
No. 1 on base			to No. 1 on top																
2	to 8																		
3	to 5																		
7	to 7																		
8	to 2																		
cap	to 3																		
	7A4	G	Change socket to loctal and rewire as follows: <table border="0"> <tr> <td>No. 2 on octal</td> <td>to No. 1 on loctal</td> </tr> <tr> <td>3</td> <td>to 2</td> </tr> <tr> <td>7</td> <td>to 8</td> </tr> <tr> <td>8</td> <td>to 7</td> </tr> <tr> <td>cap</td> <td>to 6</td> </tr> </table>	No. 2 on octal	to No. 1 on loctal	3	to 2	7	to 8	8	to 7	cap	to 6						
No. 2 on octal				to No. 1 on loctal															
3	to 2																		
7	to 8																		
8	to 7																		
cap	to 6																		
	7B4	G																	
			 																
6K6	6A4/LA	P	Parallel circuits only. Reverse 6A4/LA to 6F6 procedure.																
	6AD7	G	Parallel circuits only. Remove and tape up any wires anchored on pins Nos. 1 and 6.																
	6AR6	P	Where additional filament current is available. Reverse 6AR6 to 6F6 procedure.																

RECEIVING TUBE SUBSTITUTION GUIDE

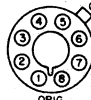
6K6-6K7

TUBE	SUB.	PERF.	CIRCUIT CHANGES NECESSARY														
6K6	6F6	G	Parallel circuits only. No changes.														
	6G6	P															
	6L6	G															
	6U6	G															
	6V6	G															
	7A5	G	Same as 6K6 to 7B5. Parallel circuits only.														
	7B5	E	Change socket to loctal and rewire as follows:														
			<table border="0"> <tr> <td>No. 2 on octal</td> <td>to No. 1 on loctal</td> </tr> <tr> <td>3</td> <td>to 2</td> </tr> <tr> <td>4</td> <td>to 3</td> </tr> <tr> <td>5</td> <td>to 6</td> </tr> <tr> <td>7</td> <td>to 8</td> </tr> <tr> <td>8</td> <td>to 7</td> </tr> </table>	No. 2 on octal	to No. 1 on loctal	3	to 2	4	to 3	5	to 6	7	to 8	8	to 7		
	No. 2 on octal	to No. 1 on loctal															
	3	to 2															
4	to 3																
5	to 6																
7	to 8																
8	to 7																
		 															
7C5	G	Same as 6K6 to 7B5. Parallel circuits only.															
38	G	Same as 6F6 to 38. Parallel circuits only.															
41	E	Same as 6F6 to 42. Parallel or series circuits.															
42	G	Same as 6F6 to 42. Parallel circuits only.															
89	G	Same as 6F6 to 89. Parallel or series circuits.															
6K7	6AU6	G	Change socket to miniature and rewire as follows:														
	6BA6	G															
	6BD6	G															
			<table border="0"> <tr> <td>No. 2 on octal</td> <td>to No. 3 on miniature</td> </tr> <tr> <td>3</td> <td>to 5</td> </tr> <tr> <td>4</td> <td>to 6</td> </tr> <tr> <td>5</td> <td>to 2</td> </tr> <tr> <td>7</td> <td>to 4</td> </tr> <tr> <td>8</td> <td>to 7</td> </tr> <tr> <td>cap</td> <td>to 1</td> </tr> </table>	No. 2 on octal	to No. 3 on miniature	3	to 5	4	to 6	5	to 2	7	to 4	8	to 7	cap	to 1
	No. 2 on octal	to No. 3 on miniature															
	3	to 5															
	4	to 6															
	5	to 2															
	7	to 4															
	8	to 7															
cap	to 1																
		 															
6C6	G	Reverse 6C6 to 6J7 procedure.															
6D6	E	.															
6D7	G	Same as 6J7 to 6D7.															
6E7	G																
6J7	G	No changes.															
6Q7	P	Cut off pins No. 4 and No. 5. Emergency substitution.															
6S7	G	Parallel circuits only. No changes.															
6SH7	G	Same as 6J7 to 6SJ7.															
6SJ7	G																
6SK7	E																
6SS7	G	Same as 12K7 to 12SK7. Parallel circuits only.															
6U7	G	No changes.															
6W7	G	Parallel circuits only. No changes.															

**6K7-6L6**

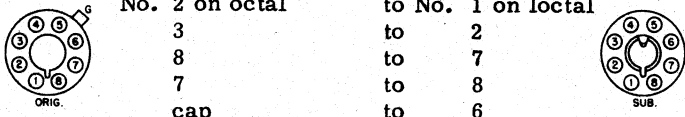
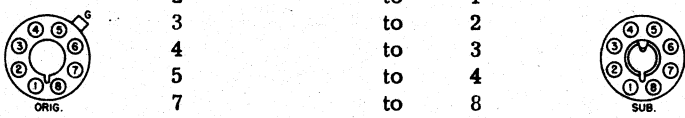
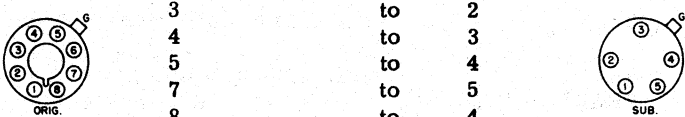

**RECEIVING TUBE SUBSTITUTION GUIDE**

TUBE	SUB.	PERF.	CIRCUIT CHANGES NECESSARY																
6K7	XXL 7A4	P P	<p>Change socket to loctal and rewire as follows:</p> <p>Remove No. 4 and tape up</p> <table border="0"> <tr> <td>No. 2 on octal</td> <td>to No. 1 on loctal</td> </tr> <tr> <td>3</td> <td>to 2</td> </tr> <tr> <td>8</td> <td>to 7</td> </tr> <tr> <td>7</td> <td>to 8</td> </tr> <tr> <td>cap</td> <td>to 6</td> </tr> </table> 	No. 2 on octal	to No. 1 on loctal	3	to 2	8	to 7	7	to 8	cap	to 6						
No. 2 on octal	to No. 1 on loctal																		
3	to 2																		
8	to 7																		
7	to 8																		
cap	to 6																		
	7A7 7H7 7L7	E G G	<p>Change socket to loctal and rewire as follows:</p> <table border="0"> <tr> <td>No. 1 on octal</td> <td>to No. 5 on loctal</td> </tr> <tr> <td>2</td> <td>to 1</td> </tr> <tr> <td>3</td> <td>to 2</td> </tr> <tr> <td>4</td> <td>to 3</td> </tr> <tr> <td>5</td> <td>to 4</td> </tr> <tr> <td>7</td> <td>to 8</td> </tr> <tr> <td>8</td> <td>to 7</td> </tr> <tr> <td>cap</td> <td>to 6</td> </tr> </table> 	No. 1 on octal	to No. 5 on loctal	2	to 1	3	to 2	4	to 3	5	to 4	7	to 8	8	to 7	cap	to 6
No. 1 on octal	to No. 5 on loctal																		
2	to 1																		
3	to 2																		
4	to 3																		
5	to 4																		
7	to 8																		
8	to 7																		
cap	to 6																		
	7B7 7C7 7G7	G G G	Same as 6K7 to 7A7. Parallel circuits only.																
	39/44	E	<p>Change socket to five prong type and rewire as follows:</p> <table border="0"> <tr> <td>No. 2 on octal</td> <td>to No. 1 on five prong</td> </tr> <tr> <td>3</td> <td>to 2</td> </tr> <tr> <td>4</td> <td>to 3</td> </tr> <tr> <td>5</td> <td>to 4</td> </tr> <tr> <td>7</td> <td>to 5</td> </tr> <tr> <td>8</td> <td>to 4</td> </tr> <tr> <td>cap</td> <td>to cap</td> </tr> </table> 	No. 2 on octal	to No. 1 on five prong	3	to 2	4	to 3	5	to 4	7	to 5	8	to 4	cap	to cap		
No. 2 on octal	to No. 1 on five prong																		
3	to 2																		
4	to 3																		
5	to 4																		
7	to 5																		
8	to 4																		
cap	to cap																		
	77 78	G E	Reverse 6C6 to 6J7 procedure.																
	1232	G	Same as 6K7 to 7A7. Parallel circuits only.																
6K8	6A8 6J8	G G	No changes.																
	7J7 7S7	G G	Same as 6J8 to 7J7.																
	7Q7	G	Same as 12A8 to 14B8.																
6L4	6F4	P	No changes.																
	955	G	Parallel circuits only. Refer to base diagram for changes.																
6L5	6AD5 6AE5	G G	Parallel circuits only. No changes.																
	6C5	G	Parallel circuits only. No changes.																
	7A4 XXL	G G	Same as 6J5 to 7A4. Parallel circuits only.																
	37 76	G G	Same as 6C5 to 37. Parallel circuits only.																
6L6	6AD7	G	Remove and tape up any wires anchored on pins Nos. 1 and 6.																





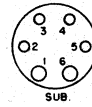

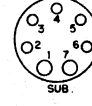

RECEIVING TUBE SUBSTITUTION GUIDE

6L6-6N7

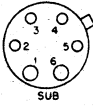
TUBE	SUB.	PERF.	CIRCUIT CHANGES NECESSARY														
6L6	6AL6	G	Rewire as follows:  Connect No. 3 to cap.														
	6AR6	G	Reverse 6AR6 to 6F6 procedure.														
	6F6	G	Parallel circuits only. No changes.														
	6K6	G															
	6U6	G															
	6V6	G															
	1614	E	No changes.														
6L7	1612	E	No changes.														
6M5			No practical substitute.														
6M6G			No practical substitute.														
6M7G			No practical substitute.														
6M8GT			No practical substitute.														
6N4	6AB4	G	Parallel circuits only. Reverse 6AB4 to 6N4 procedure.														
	6J4	G	Parallel circuits only. Reverse 6J4 to 6N4 procedure.														
6N5	6AB5	E	See 6AB5 substitutes.														
6N6	6AB6	G	Parallel circuits only. No changes.														
	6B5	E	Change socket to six prong and rewire as follows: <table border="0" style="margin-left: 40px;"> <tr> <td style="text-align: center;">No. 2 on octal</td> <td style="text-align: center;">to No. 1 on six prong</td> </tr> <tr> <td style="text-align: center;">3</td> <td style="text-align: center;">to 2</td> </tr> <tr> <td style="text-align: center;">4</td> <td style="text-align: center;">to 3</td> </tr> <tr> <td style="text-align: center;">5</td> <td style="text-align: center;">to 4</td> </tr> <tr> <td style="text-align: center;">7</td> <td style="text-align: center;">to 6</td> </tr> <tr> <td style="text-align: center;">8</td> <td style="text-align: center;">to 5</td> </tr> </table> <div style="display: flex; justify-content: space-around; align-items: center; margin-top: 10px;"> <div style="text-align: center;">  <p>ORIG.</p> </div> <div style="text-align: center;">  <p>SUB.</p> </div> </div>	No. 2 on octal	to No. 1 on six prong	3	to 2	4	to 3	5	to 4	7	to 6	8	to 5		
No. 2 on octal	to No. 1 on six prong																
3	to 2																
4	to 3																
5	to 4																
7	to 6																
8	to 5																
6N7	6A6	G	Change socket to seven prong and rewire as follows: <table border="0" style="margin-left: 40px;"> <tr> <td style="text-align: center;">No. 2 on octal</td> <td style="text-align: center;">to No. 1 on seven prong</td> </tr> <tr> <td style="text-align: center;">3</td> <td style="text-align: center;">to 2</td> </tr> <tr> <td style="text-align: center;">4</td> <td style="text-align: center;">to 3</td> </tr> <tr> <td style="text-align: center;">5</td> <td style="text-align: center;">to 5</td> </tr> <tr> <td style="text-align: center;">6</td> <td style="text-align: center;">to 6</td> </tr> <tr> <td style="text-align: center;">7</td> <td style="text-align: center;">to 7</td> </tr> <tr> <td style="text-align: center;">8</td> <td style="text-align: center;">to 4</td> </tr> </table> <div style="display: flex; justify-content: space-around; align-items: center; margin-top: 10px;"> <div style="text-align: center;">  <p>ORIG.</p> </div> <div style="text-align: center;">  <p>SUB.</p> </div> </div>	No. 2 on octal	to No. 1 on seven prong	3	to 2	4	to 3	5	to 5	6	to 6	7	to 7	8	to 4
No. 2 on octal	to No. 1 on seven prong																
3	to 2																
4	to 3																
5	to 5																
6	to 6																
7	to 7																
8	to 4																
	6AE6	P	Parallel circuits only. Reverse 6AE6 to 6N7 procedure.														
	6Y7	G	Parallel circuits only. No changes.														
	6Z7	G															

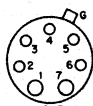
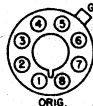

6N7-6Q7

RECEIVING TUBE SUBSTITUTION GUIDE

TUBE	SUB.	PERF.	CIRCUIT CHANGES NECESSARY																		
6N7	79	G	<p>Change socket to six prong and rewire as follows:</p> <table border="0"> <tr> <td>No. 2 on octal</td> <td>to No. 1 on six prong</td> </tr> <tr> <td>3</td> <td>to 2</td> </tr> <tr> <td>4</td> <td>to 3</td> </tr> <tr> <td>5</td> <td>to cap</td> </tr> <tr> <td>6</td> <td>to 5</td> </tr> <tr> <td>7</td> <td>to 6</td> </tr> <tr> <td>8</td> <td>to 4</td> </tr> </table>  	No. 2 on octal	to No. 1 on six prong	3	to 2	4	to 3	5	to cap	6	to 5	7	to 6	8	to 4				
No. 2 on octal	to No. 1 on six prong																				
3	to 2																				
4	to 3																				
5	to cap																				
6	to 5																				
7	to 6																				
8	to 4																				
6N8	7R7	P	<p>Change socket to loctal and rewire as follows:</p> <table border="0"> <tr> <td>No. 1 on noval</td> <td>to No. 5 on loctal</td> </tr> <tr> <td>2</td> <td>to 6</td> </tr> <tr> <td>3</td> <td>to 7</td> </tr> <tr> <td>4</td> <td>to 1</td> </tr> <tr> <td>5</td> <td>to 8</td> </tr> <tr> <td>6</td> <td>to 2</td> </tr> <tr> <td>7</td> <td>to 3</td> </tr> <tr> <td>8</td> <td>to 4</td> </tr> <tr> <td>9</td> <td>to 7</td> </tr> </table>  	No. 1 on noval	to No. 5 on loctal	2	to 6	3	to 7	4	to 1	5	to 8	6	to 2	7	to 3	8	to 4	9	to 7
No. 1 on noval	to No. 5 on loctal																				
2	to 6																				
3	to 7																				
4	to 1																				
5	to 8																				
6	to 2																				
7	to 3																				
8	to 4																				
9	to 7																				
6P5	6AD5 6AE5 6AF5 6C5 6J5	G	No changes.																		
	6L5	G	Parallel circuits only. No changes.																		
	7A4	G	Same as 6J5 to 7A4.																		
	37	G	Same as 6C5 to 37.																		
	76	G																			
6P7	6F7	E	<p>Change socket to seven prong and rewire as follows:</p> <table border="0"> <tr> <td>No. 2 on octal</td> <td>to No. 1 on seven prong</td> </tr> <tr> <td>3</td> <td>to 7</td> </tr> <tr> <td>4</td> <td>to 2</td> </tr> <tr> <td>5</td> <td>to 3</td> </tr> <tr> <td>6</td> <td>to 4</td> </tr> <tr> <td>7</td> <td>to 5</td> </tr> <tr> <td>8</td> <td>to 6</td> </tr> <tr> <td>cap</td> <td>to cap</td> </tr> </table>  	No. 2 on octal	to No. 1 on seven prong	3	to 7	4	to 2	5	to 3	6	to 4	7	to 5	8	to 6	cap	to cap		
No. 2 on octal	to No. 1 on seven prong																				
3	to 7																				
4	to 2																				
5	to 3																				
6	to 4																				
7	to 5																				
8	to 6																				
cap	to cap																				
6P8G			No practical substitute.																		
6Q5G			No practical substitute.																		
6Q6			No practical substitute.																		
6Q7	6B6	E	No changes.																		
	6C7	G	<p>Change socket to seven prong type and rewire as follows:</p> <table border="0"> <tr> <td>No. 2 on octal</td> <td>to No. 1 on seven prong</td> </tr> <tr> <td>3</td> <td>to 2</td> </tr> <tr> <td>4</td> <td>to 4</td> </tr> <tr> <td>5</td> <td>to 5</td> </tr> <tr> <td>7</td> <td>to 7</td> </tr> <tr> <td>8</td> <td>to 6</td> </tr> <tr> <td>cap</td> <td>to cap</td> </tr> </table>  	No. 2 on octal	to No. 1 on seven prong	3	to 2	4	to 4	5	to 5	7	to 7	8	to 6	cap	to cap				
No. 2 on octal	to No. 1 on seven prong																				
3	to 2																				
4	to 4																				
5	to 5																				
7	to 7																				
8	to 6																				
cap	to cap																				

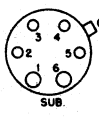

RECEIVING TUBE SUBSTITUTION GUIDE

6Q7-6S4

TUBE	SUB.	PERF.	CIRCUIT CHANGES NECESSARY														
6Q7	6SQ7	E	Same as 12Q7 to 12SQ7.														
	6SR7	G															
	6R7	G	No changes.														
	6T7	G	Parallel circuits. No changes.														
	6V7	G	No changes.														
7B6	7E6	E	Change socket to loctal and rewire as follows:														
		G															
			<table border="0"> <tr> <td>No. 2 on octal</td> <td>to No. 1 on loctal</td> </tr> <tr> <td>3</td> <td>to 2</td> </tr> <tr> <td>4</td> <td>to 5</td> </tr> <tr> <td>5</td> <td>to 6</td> </tr> <tr> <td>7</td> <td>to 8</td> </tr> <tr> <td>8</td> <td>to 7 or 4</td> </tr> <tr> <td>cap</td> <td>to 3</td> </tr> </table>	No. 2 on octal	to No. 1 on loctal	3	to 2	4	to 5	5	to 6	7	to 8	8	to 7 or 4	cap	to 3
No. 2 on octal	to No. 1 on loctal																
3	to 2																
4	to 5																
5	to 6																
7	to 8																
8	to 7 or 4																
cap	to 3																
			 														
7C6	G	Same as above. Parallel circuits only.															
75	85	E	Change socket to six prong type and rewire as follows:														
		G															
			<table border="0"> <tr> <td>No. 2 on octal</td> <td>to No. 1 on six prong</td> </tr> <tr> <td>3</td> <td>to 2</td> </tr> <tr> <td>4</td> <td>to 3</td> </tr> <tr> <td>5</td> <td>to 4</td> </tr> <tr> <td>7</td> <td>to 6</td> </tr> <tr> <td>8</td> <td>to 5</td> </tr> <tr> <td>cap</td> <td>to cap</td> </tr> </table>	No. 2 on octal	to No. 1 on six prong	3	to 2	4	to 3	5	to 4	7	to 6	8	to 5	cap	to cap
No. 2 on octal	to No. 1 on six prong																
3	to 2																
4	to 3																
5	to 4																
7	to 6																
8	to 5																
cap	to cap																
			 														
6R4			No practical substitute.														
6R6	6K7	6U7	G	Rewire as follows:													
					G												
				<table border="0"> <tr> <td>No. 3</td> <td>to No. 4</td> </tr> <tr> <td>5</td> <td>to 3</td> </tr> </table> <p>Short Nos. 5 and 8 on socket together.</p>	No. 3	to No. 4	5	to 3									
No. 3	to No. 4																
5	to 3																
6R7	6C7	G	Same as 6Q7 to 6C7.														
	6Q7	G	No changes.														
	6SQ7	G	Same as 12Q7 to 12SQ7.														
	6SR7	E															
	6T7	G	Parallel circuits only. No changes.														
	6V7	G	No changes.														
	7B6	G	Same as 6Q7 to 7B6.														
	7C6	E	Parallel circuits only. Same as 6Q7 to 7B6.														
	7E6	G	Same as 6Q7 to 7B6.														
	75	G	Same as 6Q7 to 75.														
	85	E															
6R8	6T8	G	No changes.														
6S4			No practical substitute.														



**6S6-6SC7**

**RECEIVING TUBE SUBSTITUTION GUIDE**

TUBE	SUB.	PERF.	CIRCUIT CHANGES NECESSARY			
6S6			No practical substitute.			
6SA7	7Q7	G	Same as 12SA7 to 14Q7.			
	6SB7Y	G	No changes.			
	6SD7	P	Same as 12SA7 to 12SK7.			
	6SH7 6SK7	P P				
6S8GT			No practical substitute.			
6S7	6D6	G	Parallel circuits only. Reverse 6C6 to 6J7 procedure.			
	6D7	G	Same as 6J7 to 6D7. Parallel circuits only.			
	6E7	G				
	6J7	G	Parallel circuits only. No changes.			
	6K7	G				
	6SJ7	G	Parallel circuits only. Same as 12K7 to 12SK7.			
	6SK7	G				
	6SS7	E	Same as 12K7 to 12SK7.			
	6U7	G	Parallel circuits only. No changes.			
	6W7	G	No changes.			
	7A7	G	Parallel circuits only. Same as 12K7 to 7B7.			
	7B7	G	Same as 12K7 to 7B7.			
	7C7	G				
	12K7	P	Series circuits only. No changes.			
	12SK7	P	Series circuits only. Same as 12K7 to 12SK7.			
	14A7/12B7	P	Series circuits only. Same as 12K7 to 7B7.			
	39/44	G	Parallel circuits only. Same as 6K7 to 39/44.			
	77	G	Parallel circuits only. Reverse 6C6 to 6J7 procedure.			
	78	G				
666	G					
6SB7Y	6BE6	G	Change socket to miniature and rewire as follows:			
		No. 1 on octal	to No. 2 on miniature			
		2	to	3		
		3	to	5		
		4	to	6		
		5	to	1		
		6	to	2		
		7	to	4		
		8	to	7		
						
						
6SC7	6C8	G	Same as 6SC7 to 6F8.			

RECEIVING TUBE SUBSTITUTION GUIDE

6SC7-6SF5

TUBE	SUB.	PERF.	CIRCUIT CHANGES NECESSARY
6SC7	6F8	G	Make adaptor as follows: No. 1 on base to No. 1 on top 2 to 3 3 to cap 4 to 5 5 to 6 6 to 4 and 8 7 to 7 8 to 2 Parallel circuits only.
			6SL7
6SN7		G	Same as 6SC7 to 6SL7. Parallel circuits only.
7F7		G	Change socket to loctal and rewire as follows: No. 2 on octal to No. 3 on loctal 3 to 4 4 to 5 5 to 6 6 to 2 and 7 7 to 1 8 to 8
			 
6SD7	6AB7/1853	G	Parallel circuits only. No changes.
	6AC7/1852	G	
	6SS7	G	
	6SE7	G	No changes.
	6SJ7 6SK7 5693	G G G	No changes.
6SE7	6AB7/1853	G	Parallel circuits only. No changes.
	6AC7/1852	G	
	6SS7	G	
	6SD7	G	No changes.
	6SJ7 6SK7 5693	G G G	No changes.
6SF5	6F5	E	Reverse 6F5 to 6SF5 procedure.
	6K5	G	Make adaptor as follows: No. 1 on base to No. 1 on top 2 to 8 3 to cap 5 to 3 7 to 7 8 to 2

**6SF5-6SJ7**

**RECEIVING TUBE SUBSTITUTION GUIDE**

<b>TUBE</b>	<b>SUB.</b>	<b>PERF.</b>	<b>CIRCUIT CHANGES NECESSARY</b>
6SF5	7B4	G	Change socket to loctal and rewire as follows. Parallel circuits only:

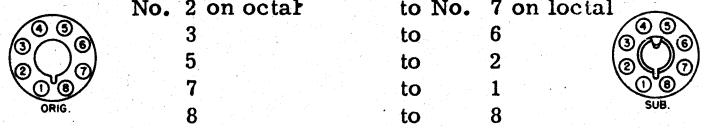

6SF7	6SV7	G	No changes..
------	------	---	--------------

6SG7	6AB7	G	Parallel circuits only. No changes.
	6AC7	G	

6AG5	G	Change socket to miniature and rewire as follows:
6BC5	G	

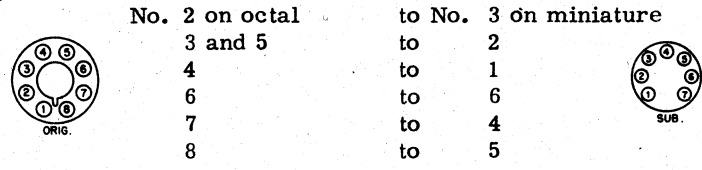

6AJ5	G	Same as 6SG7 to 6AG5. Parallel circuits only.
6AK5	G	
6AN5	G	
5591	G	
9001	G	
9003	G	

6SH7	G	No changes. Cathode and suppressor grid are internally connected in the 6SG7. In a limited number of circuits this substitution does operate. In these cases short pins 3 and 5 together.
6SJ7	G	
6SK7	G	

6SH7	6AB7	G	Parallel circuits only. No changes.
	6AC7	G	
	6AG5	G	
	6BC5	G	

6AJ5	G	Same as 6SG7 to 6AG5. Parallel circuits only.
6AK5	G	
6AN5	G	
5591	G	
9001	G	
9003	G	

6SG7	G	No changes.
6SJ7	G	
6SK7	G	

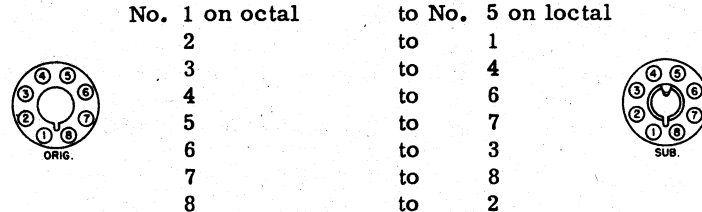

7G7/1232	G	Parallel circuits only. Change socket to loctal and rewire as follows:
----------	---	--



6SJ7	6C6	E	Reverse 6C6 to 6SJ7 procedure.
	6D6	G	
	77	E	
	78	G	



# RECEIVING TUBE SUBSTITUTION GUIDE

**6SJ7-6SK7**

TUBE	SUB.	PERF.	CIRCUIT CHANGES NECESSARY
6SJ7	6D7	G	Change socket to seven prong type and rewire as follows: No. 2 on octal                      to No. 1 on seven prong 3    to 4 4    to cap 5    to 6 6    to 3 7    to 7 8    to 2
	6E7	G	
			 
	6J7	E	Same as 12SK7 to 12K7.
	6K7	G	
	6U7	G	
	6S7	G	Same as 12SK7 to 12K7. Parallel circuits only.
	6W7	G	
	6SK7	G	No changes.
	5693	E	
	6SS7	G	Parallel circuits only. No changes.
	7A7	G	Same as 12SJ7 to 7B7.
	7B7	G	Same as 12SJ7 to 7B7. Parallel circuits only.
	7C7	G	
6SK7	6AB7	G	Parallel circuits only. No changes.
	6AC7	G	
	6AH6	G	Same as 6SK7 to 6AU6. Parallel circuits only.
	6AK6	G	
	6AU6	G	Change socket to miniature and rewire as follows: No. 2 on octal                      to No. 3 on miniature 3    to 2 4    to 1 5    to 7 6    to 6 7    to 4 8    to 5
	6BA6	G	
	6BD6	G	
	6C6	G	
	6D6	E	Reverse 6C6 to 6SJ7 procedure.
	77	G	
	78	E	
	6D7	G	
	6E7	G	Same as 6SJ7 to 6D7.
	6J7	G	Same as 12SK7 to 12K7.
	6K7	E	
	6U7	G	
	6S7	G	Same as 12SK7 to 12K7. Parallel circuits only.
	6W7	G	
	6SG7	G	No changes.
	6SH7	G	
	6SJ7	G	No changes.

**6SK7-6SN7**

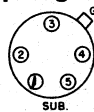







**RECEIVING TUBE SUBSTITUTION GUIDE**

TUBE	SUB.	PERF.	CIRCUIT CHANGES NECESSARY																								
6SK7	6SS7	G	Parallel circuits only. No changes.																								
	36	G	Change socket to five prong and rewire as follows:																								
	39/44	E																									
			<table border="0"> <tr> <td>No. 2 on octal</td> <td>to No. 1 on five prong</td> </tr> <tr> <td>3 and 5</td> <td>to 4</td> </tr> <tr> <td>4</td> <td>to cap</td> </tr> <tr> <td>6</td> <td>to 3</td> </tr> <tr> <td>7</td> <td>to 5</td> </tr> <tr> <td>8</td> <td>to 2</td> </tr> </table>	No. 2 on octal	to No. 1 on five prong	3 and 5	to 4	4	to cap	6	to 3	7	to 5	8	to 2												
No. 2 on octal	to No. 1 on five prong																										
3 and 5	to 4																										
4	to cap																										
6	to 3																										
7	to 5																										
8	to 2																										
			 																								
	7A7	E	Same as 12SJ7 to 7B7.																								
	7B7	E	Same as 12SJ7 to 7B7. Parallel circuits only.																								
	7C7	G																									
6SL7	2C21	P	Reverse 2C21 to 6SN7 procedure.																								
	6C8	G	Same as 6SL7 to 6F8.																								
	6F8	G	Make adaptor as follows: <table border="0"> <tr> <td>No. 1 on base</td> <td>to</td> <td>cap on top</td> </tr> <tr> <td>2</td> <td>to</td> <td>3</td> </tr> <tr> <td>3</td> <td>to</td> <td>4</td> </tr> <tr> <td>4</td> <td>to</td> <td>5</td> </tr> <tr> <td>5</td> <td>to</td> <td>6</td> </tr> <tr> <td>6</td> <td>to</td> <td>8</td> </tr> <tr> <td>7</td> <td>to</td> <td>7</td> </tr> <tr> <td>8</td> <td>to</td> <td>2</td> </tr> </table>	No. 1 on base	to	cap on top	2	to	3	3	to	4	4	to	5	5	to	6	6	to	8	7	to	7	8	to	2
No. 1 on base	to	cap on top																									
2	to	3																									
3	to	4																									
4	to	5																									
5	to	6																									
6	to	8																									
7	to	7																									
8	to	2																									
	6SC7	G	If the 6SL7 employs the two cathodes separately this substitution may be impractical. Reverse 6SC7 to 6SL7 procedure.																								
	6SN7	G	Parallel circuits only. No changes.																								
	6SU7	G	No changes.																								
	7F7	G	Change socket to loctal and rewire as follows: <table border="0"> <tr> <td>No. 1 on octal</td> <td>to No. 4 on loctal</td> </tr> <tr> <td>2</td> <td>to 3</td> </tr> <tr> <td>3</td> <td>to 2</td> </tr> <tr> <td>4</td> <td>to 5</td> </tr> <tr> <td>5</td> <td>to 6</td> </tr> <tr> <td>6</td> <td>to 7</td> </tr> <tr> <td>7</td> <td>to 1</td> </tr> <tr> <td>8</td> <td>to 8</td> </tr> </table>	No. 1 on octal	to No. 4 on loctal	2	to 3	3	to 2	4	to 5	5	to 6	6	to 7	7	to 1	8	to 8								
No. 1 on octal	to No. 4 on loctal																										
2	to 3																										
3	to 2																										
4	to 5																										
5	to 6																										
6	to 7																										
7	to 1																										
8	to 8																										
			 																								
	7N7	G	Same as 6SL7 to 7F7. Parallel circuits only.																								
	5691	E	No changes.																								
	5692	P																									
6SN7	2C21	G	Reverse 2C21 to 6SN7 procedure.																								
	6F8	G	Same as 6SL7 to 6F8. Parallel circuits only.																								
	6SC7	G	Reverse 6SC7 to 6SL7 procedure. Parallel circuits only.																								
	6SL7	G	Parallel circuits only. No changes.																								
	7F7	G	Same as 6SL7 to 7F7. Parallel circuits only.																								



# RECEIVING TUBE SUBSTITUTION GUIDE

**6SN7-6SQ7**

TUBE	SUB.	PERF.	CIRCUIT CHANGES NECESSARY																										
6SN7	7F8	G	<p>Parallel circuits only. Change socket to loctal and rewire as follows:</p> <table style="margin-left: 40px;"> <tr> <td style="text-align: right;">No. 1 on octal</td> <td style="text-align: right;">to No. 1 on loctal</td> </tr> <tr> <td style="text-align: right;">2</td> <td style="text-align: right;">to 3</td> </tr> <tr> <td style="text-align: right;">3</td> <td style="text-align: right;">to 4</td> </tr> <tr> <td style="text-align: right;">4</td> <td style="text-align: right;">to 8</td> </tr> <tr> <td style="text-align: right;">5</td> <td style="text-align: right;">to 6</td> </tr> <tr> <td style="text-align: right;">6</td> <td style="text-align: right;">to 5</td> </tr> <tr> <td style="text-align: right;">7</td> <td style="text-align: right;">to 7</td> </tr> <tr> <td style="text-align: right;">8</td> <td style="text-align: right;">to 2</td> </tr> </table> <div style="display: flex; justify-content: space-around; align-items: center; margin-top: 10px;">  <table style="margin: 0 20px;"> <tr><td style="text-align: right;">3</td><td style="text-align: right;">to 2</td></tr> <tr><td style="text-align: right;">4</td><td style="text-align: right;">to 5</td></tr> <tr><td style="text-align: right;">5</td><td style="text-align: right;">to 4</td></tr> <tr><td style="text-align: right;">6</td><td style="text-align: right;">to 3</td></tr> </table>  </div>	No. 1 on octal	to No. 1 on loctal	2	to 3	3	to 4	4	to 8	5	to 6	6	to 5	7	to 7	8	to 2	3	to 2	4	to 5	5	to 4	6	to 3		
No. 1 on octal	to No. 1 on loctal																												
2	to 3																												
3	to 4																												
4	to 8																												
5	to 6																												
6	to 5																												
7	to 7																												
8	to 2																												
3	to 2																												
4	to 5																												
5	to 4																												
6	to 3																												
	5691	P	No changes.																										
	5692	G	No changes.																										
6SQ7	6AQ6	G	Same as 6SQ7 to 6AT6. Parallel circuits only.																										
	6AT6	G	Change socket to miniature and rewire as follows:																										
	6AV6	G	<table style="margin-left: 40px;"> <tr> <td style="text-align: right;">No. 2 on octal</td> <td style="text-align: right;">to No. 1 on miniature</td> </tr> <tr> <td style="text-align: right;">3</td> <td style="text-align: right;">to 2</td> </tr> <tr> <td style="text-align: right;">4</td> <td style="text-align: right;">to 5</td> </tr> <tr> <td style="text-align: right;">5</td> <td style="text-align: right;">to 6</td> </tr> <tr> <td style="text-align: right;">6</td> <td style="text-align: right;">to 7</td> </tr> <tr> <td style="text-align: right;">7</td> <td style="text-align: right;">to 4</td> </tr> <tr> <td style="text-align: right;">8</td> <td style="text-align: right;">to 3</td> </tr> </table> <div style="display: flex; justify-content: space-around; align-items: center; margin-top: 10px;">  <table style="margin: 0 20px;"> <tr><td style="text-align: right;">3</td><td style="text-align: right;">to 2</td></tr> <tr><td style="text-align: right;">4</td><td style="text-align: right;">to 5</td></tr> <tr><td style="text-align: right;">5</td><td style="text-align: right;">to 6</td></tr> <tr><td style="text-align: right;">6</td><td style="text-align: right;">to 7</td></tr> <tr><td style="text-align: right;">7</td><td style="text-align: right;">to 4</td></tr> <tr><td style="text-align: right;">8</td><td style="text-align: right;">to 3</td></tr> </table>  </div>	No. 2 on octal	to No. 1 on miniature	3	to 2	4	to 5	5	to 6	6	to 7	7	to 4	8	to 3	3	to 2	4	to 5	5	to 6	6	to 7	7	to 4	8	to 3
No. 2 on octal	to No. 1 on miniature																												
3	to 2																												
4	to 5																												
5	to 6																												
6	to 7																												
7	to 4																												
8	to 3																												
3	to 2																												
4	to 5																												
5	to 6																												
6	to 7																												
7	to 4																												
8	to 3																												
	6BK6	G																											
	6BT6	G																											
	6BU6	G																											
	6B6	G	<p>Make adaptor as follows:</p> <table style="margin-left: 40px;"> <tr> <td style="text-align: right;">No. 1 on base</td> <td style="text-align: right;">to No. 1 on top</td> </tr> <tr> <td style="text-align: right;">2</td> <td style="text-align: right;">to cap</td> </tr> <tr> <td style="text-align: right;">3</td> <td style="text-align: right;">to 8</td> </tr> <tr> <td style="text-align: right;">4</td> <td style="text-align: right;">to 4</td> </tr> <tr> <td style="text-align: right;">5</td> <td style="text-align: right;">to 5</td> </tr> <tr> <td style="text-align: right;">7</td> <td style="text-align: right;">to 7</td> </tr> <tr> <td style="text-align: right;">8</td> <td style="text-align: right;">to 2</td> </tr> </table>	No. 1 on base	to No. 1 on top	2	to cap	3	to 8	4	to 4	5	to 5	7	to 7	8	to 2												
No. 1 on base	to No. 1 on top																												
2	to cap																												
3	to 8																												
4	to 4																												
5	to 5																												
7	to 7																												
8	to 2																												
	6C7	G	<p>Change socket to seven prong and rewire as follows:</p> <table style="margin-left: 40px;"> <tr> <td style="text-align: right;">No. 2 on octal</td> <td style="text-align: right;">to cap on seven prong</td> </tr> <tr> <td style="text-align: right;">3</td> <td style="text-align: right;">to 6</td> </tr> <tr> <td style="text-align: right;">4</td> <td style="text-align: right;">to 4</td> </tr> <tr> <td style="text-align: right;">5</td> <td style="text-align: right;">to 5</td> </tr> <tr> <td style="text-align: right;">6</td> <td style="text-align: right;">to 2</td> </tr> <tr> <td style="text-align: right;">7</td> <td style="text-align: right;">to 1</td> </tr> <tr> <td style="text-align: right;">8</td> <td style="text-align: right;">to 7</td> </tr> </table> <div style="display: flex; justify-content: space-around; align-items: center; margin-top: 10px;">  <table style="margin: 0 20px;"> <tr><td style="text-align: right;">3</td><td style="text-align: right;">to 6</td></tr> <tr><td style="text-align: right;">4</td><td style="text-align: right;">to 4</td></tr> <tr><td style="text-align: right;">5</td><td style="text-align: right;">to 5</td></tr> <tr><td style="text-align: right;">6</td><td style="text-align: right;">to 2</td></tr> <tr><td style="text-align: right;">7</td><td style="text-align: right;">to 1</td></tr> <tr><td style="text-align: right;">8</td><td style="text-align: right;">to 7</td></tr> </table>  </div>	No. 2 on octal	to cap on seven prong	3	to 6	4	to 4	5	to 5	6	to 2	7	to 1	8	to 7	3	to 6	4	to 4	5	to 5	6	to 2	7	to 1	8	to 7
No. 2 on octal	to cap on seven prong																												
3	to 6																												
4	to 4																												
5	to 5																												
6	to 2																												
7	to 1																												
8	to 7																												
3	to 6																												
4	to 4																												
5	to 5																												
6	to 2																												
7	to 1																												
8	to 7																												
	6Q7	E	Same as 6SQ7 to 6B6.																										
	6R7	G	Same as 6SQ7 to 6B6.																										
	6SR7	G	No changes.																										
	6ST7	G	Parallel circuits only. No changes.																										
	6T7	G	Same as 6SQ7 to 6B6. Parallel circuits only.																										
	6V7	G	Same as 6SQ7 to 6B6. Parallel circuits only.																										
	7B6	E	Change socket to loctal and rewire as follows:																										
	7E6	G	<table style="margin-left: 40px;"> <tr> <td style="text-align: right;">No. 2 on octal</td> <td style="text-align: right;">to No. 3 on loctal</td> </tr> <tr> <td style="text-align: right;">3</td> <td style="text-align: right;">to 4 or 7</td> </tr> <tr> <td style="text-align: right;">4</td> <td style="text-align: right;">to 5</td> </tr> <tr> <td style="text-align: right;">5</td> <td style="text-align: right;">to 6</td> </tr> <tr> <td style="text-align: right;">6</td> <td style="text-align: right;">to 2</td> </tr> <tr> <td style="text-align: right;">7</td> <td style="text-align: right;">to 1</td> </tr> <tr> <td style="text-align: right;">8</td> <td style="text-align: right;">to 8</td> </tr> </table> <div style="display: flex; justify-content: space-around; align-items: center; margin-top: 10px;">  <table style="margin: 0 20px;"> <tr><td style="text-align: right;">3</td><td style="text-align: right;">to 4 or 7</td></tr> <tr><td style="text-align: right;">4</td><td style="text-align: right;">to 5</td></tr> <tr><td style="text-align: right;">5</td><td style="text-align: right;">to 6</td></tr> <tr><td style="text-align: right;">6</td><td style="text-align: right;">to 2</td></tr> <tr><td style="text-align: right;">7</td><td style="text-align: right;">to 1</td></tr> <tr><td style="text-align: right;">8</td><td style="text-align: right;">to 8</td></tr> </table>  </div>	No. 2 on octal	to No. 3 on loctal	3	to 4 or 7	4	to 5	5	to 6	6	to 2	7	to 1	8	to 8	3	to 4 or 7	4	to 5	5	to 6	6	to 2	7	to 1	8	to 8
No. 2 on octal	to No. 3 on loctal																												
3	to 4 or 7																												
4	to 5																												
5	to 6																												
6	to 2																												
7	to 1																												
8	to 8																												
3	to 4 or 7																												
4	to 5																												
5	to 6																												
6	to 2																												
7	to 1																												
8	to 8																												

**6SQ7-6SS7**

**RECEIVING TUBE SUBSTITUTION GUIDE**

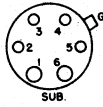
TUBE	SUB.	PERF.	CIRCUIT CHANGES NECESSARY																					
6SQ7	7C6	G	Same as above. Parallel circuits only.																					
	75	E	Change socket to six prong and rewire as follows:																					
	85	G																						
			<table border="0"> <tr> <td>No. 2 on octal</td> <td>to</td> <td>cap on six prong</td> </tr> <tr> <td>3</td> <td>to</td> <td>5</td> </tr> <tr> <td>4</td> <td>to</td> <td>3</td> </tr> <tr> <td>5</td> <td>to</td> <td>4</td> </tr> <tr> <td>6</td> <td>to</td> <td>2</td> </tr> <tr> <td>7</td> <td>to</td> <td>1</td> </tr> <tr> <td>8</td> <td>to</td> <td>6</td> </tr> </table>	No. 2 on octal	to	cap on six prong	3	to	5	4	to	3	5	to	4	6	to	2	7	to	1	8	to	6
No. 2 on octal	to	cap on six prong																						
3	to	5																						
4	to	3																						
5	to	4																						
6	to	2																						
7	to	1																						
8	to	6																						
			 																					
6SR7	6AQ6	G	Same as 6SQ7 to 6AT6. Parallel circuits only.																					
	6AT6	G	Same as 6SQ7 to 6AT6.																					
	6AV6	G																						
	6BF6	G																						
	6BK6	G																						
	6BT6	G																						
	6BU6	G																						
	6B6	G		Same as 6SQ7 to 6B6.																				
	6Q7	G																						
	6C7	G	Same as 6SQ7 to 6C7.																					
	6R7	E	Same as 6SQ7 to 6B6.																					
	6V7	G																						
	6SQ7	G	No changes.																					
	6ST7	G	Parallel circuits only. No changes.																					
	6SZ7	G	Parallel circuits only. No changes.																					
	6T7	G	Same as 6SQ7 to 6B6. Parallel circuits only.																					
	75	G	Same as 6SQ7 to 75.																					
	85	E																						
6SS7	6AK6	G	Same as 6SK7 to 6AU6.																					
	6AH6	G	Same as 6SK7 to 6AU6. Parallel circuits only.																					
	6AU6	G																						
	6BA6	G																						
	6BD6	G																						
	6S7	G	Same as 12SK7 to 12K7.																					
	6SG7	E																						
	6W7	E																						
	6SJ7	G	Parallel circuits only. No changes.																					
	6SK7	G																						
	7B7	G	Same as 12SJ7 to 7B7.																					
	7C7	G																						
	12K7	P	Same as 12SK7 to 12K7. Series circuits only.																					
	12SK7	P	Series circuits only. No changes.																					
	14A7/12B7	P	Same as 12SJ7 to 7B7. Series circuits only.																					

## RECEIVING TUBE SUBSTITUTION GUIDE

6ST7-6U6









TUBE	SUB.	PERF.	CIRCUIT CHANGES NECESSARY
6ST7	6SQ7	G	Parallel circuits only. No changes.
	6SR7	G	
6SU7	6T7	E	Same as 6SQ7 to 6B6.
	6SL7	E	No changes.
	6SN7	P	
6SV7	6SF7	G	No changes.
6SZ7	6SQ7	G	Parallel circuits only. No changes.
	6SR7	G	
6T5	6ST7	G	No changes.
	2E5	E	Heater voltage-current ratings differ.
	6AB5	G	Parallel circuits only. No changes.
	6E5	G	No changes.
6G5	G		
6U5	G		
6T6			No practical substitute.
6T7	6B6	G	Parallel circuits only. No changes.
	6Q7	G	Parallel circuits only. No changes.
	6R7	G	
	6SQ7	G	Same as 12Q7 to 12SQ7. Parallel circuits only.
	6ST7	E	Same as 12Q7 to 12SQ7.
	6V7	G	Parallel circuits only. No changes.
	7B6	G	Same as 6Q7 to 7B6. Parallel circuits only.
	7C6	G	Same as 6Q7 to 7B6.
	12Q7	P	Series circuits only. No changes.
	12SQ7	P	Same as 12Q7 to 12SQ7. Series circuits only.
	75	G	Same as 6Q7 to 75. Parallel circuits only.
	85	G	
6T8 *	6R8	G	No changes.
6U4	6W4	E	No changes.
6U5/6C5	6N5	E	Parallel circuits only. No changes.
6U5/6G5	2E5	E	Heater voltage-current ratings differ.
	6E5	E	No changes.
6U6	6A4/LA	P	Parallel circuits only. Reverse 6A4/LA to 6F6 procedure.
	6AR6	P	Where additional filament current is available. Reverse 6AR6 to 6F6 procedure.

**6U6-6V6**

**RECEIVING TUBE SUBSTITUTION GUIDE**











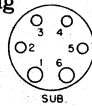

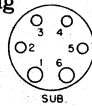

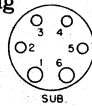

TUBE	SUB.	PERF.	CIRCUIT CHANGES NECESSARY
6U6	6F6	G	Parallel circuits. No changes.
	6G6	P	
	6K6	G	
	6L6	P	
	6V6	G	
6U7	6W6	P	Same as 6K7 to 6AU6.
	6AU6	G	
	6BA6	G	
	6BD6	G	Reverse 6C6 to 6J7 procedure.
	6C6-77	G	
	6D6-78	G	Same as 6J7 to 6D7.
	6D7	G	
	6E7	G	No changes.
	6K7	G	
	6S7	G	Same as 6J7 to 6SJ7.
	6SH7	G	
	6SJ7	G	
	6SK7	G	
	6SS7	G	
	6W7	G	
	7A7	G	Same as 6K7 to 7A7.
	7B7	G	Same as 6K7 to 7A7. Parallel circuits only.
	7C7	G	
7G7	G		
36	G	Same as 6K7 to 39/44.	
39/44	G		
6V4	6X4	E	Reverse 6X4 to 6V4 procedure.
	6X5	G	Where space permits, reverse 6X5 to 6V4 procedure.
6V6	6A4/LA	P	Parallel circuits only. Reverse 6A4/LA to 6F6 procedure.
	6AD7	G	Parallel circuits only. Remove and tape up any wires anchored on pins Nos. 1 and 6.
	6AQ5	G	Reverse 6AQ5 to 6V6 procedure.
	6AR6	P	Where additional filament current is available. Reverse 6AR6 to 6F6 procedure.
	6F6	G	Parallel circuits only. No changes.
	6G6	P	
	6K6	G	
	6L6	G	Parallel circuits only. No changes.
	6U6	G	
	6Y6	G	
7A5	G	Parallel circuits only. Remove and tape up any wires anchored on pins Nos. 1 and 6.	

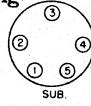

TUBE	SUB.	PERF.	CIRCUIT CHANGES NECESSARY																			
6W7	6J7	G	Parallel circuits only. No changes.																			
	6K7	G																				
	6S7	G	No changes.																			
	6SH7	G	Same as 6J7 to 6SJ7. Parallel circuits only.																			
	6SJ7	G																				
	6SK7	G																				
	6U7	G	Parallel circuits only. No changes.																			
	7A7	G	Same as 6K7 to 7A7. Parallel circuits only.																			
	7B7	G	Same as 6K7 to 7A7.																			
	7C7	G																				
	7H7	G	Same as 6K7 to 7A7. Parallel circuits only.																			
	7L7	G	Same as 6K7 to 7A7. Parallel circuits only.																			
	12J7	P	No change. Series circuits only.																			
	12K7	P																				
	77-6C6	G	Reverse 6C6 to 6J7 procedure. Parallel circuits only.																			
78-6D6	G																					
6X4	6V4	E	Change socket to noval and rewire as follows:																			
			<table border="0"> <tr> <td></td> <td>No. 1 on miniature</td> <td>to No. 1 on noval</td> <td></td> </tr> <tr> <td></td> <td>3</td> <td>to</td> <td>4</td> </tr> <tr> <td></td> <td>4</td> <td>to</td> <td>5</td> </tr> <tr> <td></td> <td>6</td> <td>to</td> <td>7</td> </tr> <tr> <td></td> <td>7</td> <td>to</td> <td>3</td> </tr> </table>		No. 1 on miniature	to No. 1 on noval			3	to	4		4	to	5		6	to	7		7	to
	No. 1 on miniature	to No. 1 on noval																				
	3	to	4																			
	4	to	5																			
	6	to	7																			
	7	to	3																			
6X5	E	Where space permits. Change socket to octal and rewire as follows:																				
		<table border="0"> <tr> <td></td> <td>No. 1 on miniature</td> <td>to No. 3 on octal</td> <td></td> </tr> <tr> <td></td> <td>3</td> <td>to</td> <td>2</td> </tr> <tr> <td></td> <td>4</td> <td>to</td> <td>7</td> </tr> <tr> <td></td> <td>6</td> <td>to</td> <td>5</td> </tr> <tr> <td></td> <td>7</td> <td>to</td> <td>8</td> </tr> </table>		No. 1 on miniature	to No. 3 on octal			3	to	2		4	to	7		6	to	5		7	to	8
	No. 1 on miniature	to No. 3 on octal																				
	3	to	2																			
	4	to	7																			
	6	to	5																			
	7	to	8																			
84/6Z4	G	Parallel circuits only. Where space permits, reverse 84/6Z4 to 6X4 procedure.																				
5726	G	Parallel circuits only. Reverse 5726 to 6X4 procedure.																				
6X5	6AX5	G	Parallel circuits only. No changes.																			
	6AX6	G	Parallel circuits only. Tie no. 4 and no. 8 together.																			
	6BY5	G	Parallel circuits only. Rewire as follows:																			
			<p>Connect Nos. 1 and 8 together</p> <p>No. 3 to No. 4</p>																			
6V4	G	Change socket to noval and rewire as follows:																				
		<table border="0"> <tr> <td></td> <td>No. 2 on octal</td> <td>to No. 4 on noval</td> <td></td> </tr> <tr> <td></td> <td>3</td> <td>to</td> <td>1</td> </tr> <tr> <td></td> <td>5</td> <td>to</td> <td>7</td> </tr> <tr> <td></td> <td>7</td> <td>to</td> <td>5</td> </tr> <tr> <td></td> <td>8</td> <td>to</td> <td>3</td> </tr> </table>		No. 2 on octal	to No. 4 on noval			3	to	1		5	to	7		7	to	5		8	to	3
	No. 2 on octal	to No. 4 on noval																				
	3	to	1																			
	5	to	7																			
	7	to	5																			
	8	to	3																			

# RECEIVING TUBE SUBSTITUTION GUIDE

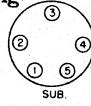
**6X5-6Y6**

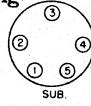
TUBE	SUB.	PERF.	CIRCUIT CHANGES NECESSARY																				
6X5	6W5	G	Parallel circuits only. No changes.																				
	6X4	G	Reverse 6X4 to 6X5 procedure.																				
	6Y5	E	Parallel circuits only. Change socket to six prong and rewire as follows:																				
			<table border="0" style="margin: auto;"> <tr> <td style="text-align: center;"></td> <td style="text-align: center;">No. 2 on octal</td> <td style="text-align: center;">to No. 1 on six prong</td> <td style="text-align: center;"></td> </tr> <tr> <td></td> <td style="text-align: center;">3</td> <td style="text-align: center;">to 3</td> <td></td> </tr> <tr> <td></td> <td style="text-align: center;">5</td> <td style="text-align: center;">to 5</td> <td></td> </tr> <tr> <td></td> <td style="text-align: center;">7</td> <td style="text-align: center;">to 6</td> <td></td> </tr> <tr> <td></td> <td style="text-align: center;">8</td> <td style="text-align: center;">to 4</td> <td></td> </tr> </table>		No. 2 on octal	to No. 1 on six prong			3	to 3			5	to 5			7	to 6			8	to 4	
	No. 2 on octal	to No. 1 on six prong																					
	3	to 3																					
	5	to 5																					
	7	to 6																					
	8	to 4																					
	0Z4	E	No changes. Do not use where AC plate voltage exceeds 250 volts per plate.																				
	6Z5	G	Same as 6X5 to 6Y5. Parallel circuits only.																				
	6Z6	G	Same as 6W5 to 6Z6.																				
	6ZY5	G	Parallel circuits only. No changes.																				
	7Y4	E	Parallel circuits only. Change socket to loctal and rewire as follows:																				
			<table border="0" style="margin: auto;"> <tr> <td style="text-align: center;"></td> <td style="text-align: center;">No. 2 on octal</td> <td style="text-align: center;">to No. 1 on loctal</td> <td style="text-align: center;"></td> </tr> <tr> <td></td> <td style="text-align: center;">3</td> <td style="text-align: center;">to 3</td> <td></td> </tr> <tr> <td></td> <td style="text-align: center;">5</td> <td style="text-align: center;">to 6</td> <td></td> </tr> <tr> <td></td> <td style="text-align: center;">7</td> <td style="text-align: center;">to 8</td> <td></td> </tr> <tr> <td></td> <td style="text-align: center;">8</td> <td style="text-align: center;">to 7</td> <td></td> </tr> </table>		No. 2 on octal	to No. 1 on loctal			3	to 3			5	to 6			7	to 8			8	to 7	
	No. 2 on octal	to No. 1 on loctal																					
	3	to 3																					
	5	to 6																					
	7	to 8																					
	8	to 7																					
	7Z4	G	Same as 6X5 to 7Y4.																				
	84	E	Change socket to five prong and rewire as follows:																				
			<table border="0" style="margin: auto;"> <tr> <td style="text-align: center;"></td> <td style="text-align: center;">No. 2 on octal</td> <td style="text-align: center;">to No. 1 on five prong</td> <td style="text-align: center;"></td> </tr> <tr> <td></td> <td style="text-align: center;">3</td> <td style="text-align: center;">to 2</td> <td></td> </tr> <tr> <td></td> <td style="text-align: center;">5</td> <td style="text-align: center;">to 3</td> <td></td> </tr> <tr> <td></td> <td style="text-align: center;">7</td> <td style="text-align: center;">to 5</td> <td></td> </tr> <tr> <td></td> <td style="text-align: center;">8</td> <td style="text-align: center;">to 4</td> <td></td> </tr> </table>		No. 2 on octal	to No. 1 on five prong			3	to 2			5	to 3			7	to 5			8	to 4	
	No. 2 on octal	to No. 1 on five prong																					
	3	to 2																					
	5	to 3																					
	7	to 5																					
	8	to 4																					
	1274	G	Parallel circuits only. No changes.																				
6X6G			No practical substitute.																				
6Y3G			No practical substitute.																				
6Y5	6X5	G	Parallel circuits only. Reverse 6X5 to 6Y5 procedure.																				
	6Z5	G	Rewire as follows:																				
			Connect Nos. 2 and 6 together.																				
6Y6	6AR6	G	Reverse 6AR6 to 6F6 procedure.																				
	6G6	P	Parallel circuits only. No changes.																				
	6K6	G																					
	6L6	G																					
	6U6	G																					
	6V6	G																					
	7A5	G	Same as 6K6 to 7B5. Parallel circuits only.																				
	7B5	G	Same as 6K6 to 7B5. Parallel circuits only.																				
	7C5	G																					

6Y7-6ZY5

RECEIVING TUBE SUBSTITUTION GUIDE

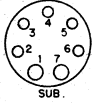
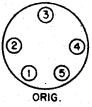
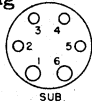





TUBE	SUB.	PERF.	CIRCUIT CHANGES NECESSARY														
6Y7*	6A6	G	Change socket to seven prong and rewire as follows: <table border="0" style="margin-left: 40px;"> <tr> <td>No. 2 on octal</td> <td>to No. 1 on seven prong</td> </tr> <tr> <td>3</td> <td>to 2</td> </tr> <tr> <td>4</td> <td>to 3</td> </tr> <tr> <td>5</td> <td>to 5</td> </tr> <tr> <td>6</td> <td>to 6</td> </tr> <tr> <td>7</td> <td>to 7</td> </tr> <tr> <td>8</td> <td>to 4</td> </tr> </table> <div style="display: flex; justify-content: space-around; align-items: center; margin-top: 10px;"> <div style="text-align: center;">  <p>ORIG.</p> </div> <div style="text-align: center;">  <p>SUB.</p> </div> </div>	No. 2 on octal	to No. 1 on seven prong	3	to 2	4	to 3	5	to 5	6	to 6	7	to 7	8	to 4
No. 2 on octal	to No. 1 on seven prong																
3	to 2																
4	to 3																
5	to 5																
6	to 6																
7	to 7																
8	to 4																
	6N7 6Z7	G G	Parallel circuits only. No changes.														
6Z3	1V	E	No changes.														
6Z4	6Y5	G	Parallel circuits only. Change socket to six prong and rewire as follows: <table border="0" style="margin-left: 40px;"> <tr> <td>No. 1 on five prong</td> <td>to No. 1 on six prong</td> </tr> <tr> <td>2</td> <td>to 3</td> </tr> <tr> <td>3</td> <td>to 5</td> </tr> <tr> <td>4</td> <td>to 4</td> </tr> <tr> <td>5</td> <td>to 6</td> </tr> </table> <div style="display: flex; justify-content: space-around; align-items: center; margin-top: 10px;"> <div style="text-align: center;">  <p>ORIG.</p> </div> <div style="text-align: center;">  <p>SUB.</p> </div> </div>	No. 1 on five prong	to No. 1 on six prong	2	to 3	3	to 5	4	to 4	5	to 6				
No. 1 on five prong	to No. 1 on six prong																
2	to 3																
3	to 5																
4	to 4																
5	to 6																
6Z5	6Y5	E	No changes for six volt operation.														
6Z7	6A6	G	Same as 6Y7 to 6A6. Parallel circuits only.														
	6N7 6Y7	G G	Parallel circuits only. No changes.														
6ZY5	0Z4	G	No changes. Do not use where AC plate voltage exceeds 250 volts per plate.														
	6AX5	G	Parallel circuits only. No changes.														
	6AX6	G	Parallel circuits only. Tie Nos. 4 and 8 together.														
	6BY5	G	Parallel circuits only. Rewire as follows:  <table border="0" style="margin-left: 40px; margin-top: 10px;"> <tr> <td>Connect Nos. 1 and 8 together</td> <td></td> </tr> <tr> <td>No. 3</td> <td>to No. 4</td> </tr> </table>	Connect Nos. 1 and 8 together		No. 3	to No. 4										
Connect Nos. 1 and 8 together																	
No. 3	to No. 4																
	6W5	G	Parallel circuits only. No changes.														
	6X5	G	Parallel circuits only. No changes.														
	6Y5 6Z5	G G	Same as 6X5 to 6Y5. Parallel circuits only.														
	7Y4 7Z4	G G	Same as 6X5 to 7Y4. Parallel circuits only.														
	84	G	Same as 6X5 to 84. Parallel circuits only.														
	1274	G	Parallel circuits only. No changes.														

\* See Addendum at back of this section.

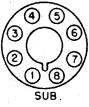

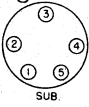
# RECEIVING TUBE SUBSTITUTION GUIDE

7A4-7A7

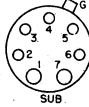
TUBE	SUB.	PERF.	CIRCUIT CHANGES NECESSARY														
7A4	6AE5	G	Change socket to octal and rewire as follows: <div style="display: flex; align-items: center; justify-content: space-around;"> <div style="text-align: center;">  <p>ORIG.</p> </div> <table style="border: none;"> <tr> <td style="padding-right: 20px;">No. 2 on loctal</td> <td style="padding-right: 20px;">to No. 3 on octal</td> </tr> <tr> <td>1</td> <td>2</td> </tr> <tr> <td>6</td> <td>5</td> </tr> <tr> <td>7</td> <td>8</td> </tr> <tr> <td>8</td> <td>7</td> </tr> </table> <div style="text-align: center;">  <p>SUB.</p> </div> </div>	No. 2 on loctal	to No. 3 on octal	1	2	6	5	7	8	8	7				
No. 2 on loctal	to No. 3 on octal																
1	2																
6	5																
7	8																
8	7																
	6C5	G	Reverse 6J5 to 7A4 procedure.														
	6J5	G	Reverse 6J5 to 7A4 procedure.														
	6L5	G	Same as 7A4 to 6AE5. Parallel circuits only.														
	7B4	G	No changes.														
	XXL	E															
	37	G	Change socket to five prong and rewire as follows														
	76	G	<div style="display: flex; align-items: center; justify-content: space-around;"> <div style="text-align: center;">  <p>ORIG.</p> </div> <table style="border: none;"> <tr> <td style="padding-right: 20px;">No. 1 on loctal</td> <td style="padding-right: 20px;">to No. 1 on five prong</td> </tr> <tr> <td>2</td> <td>2</td> </tr> <tr> <td>6</td> <td>3</td> </tr> <tr> <td>7</td> <td>4</td> </tr> <tr> <td>8</td> <td>5</td> </tr> </table> <div style="text-align: center;">  <p>SUB.</p> </div> </div>	No. 1 on loctal	to No. 1 on five prong	2	2	6	3	7	4	8	5				
No. 1 on loctal	to No. 1 on five prong																
2	2																
6	3																
7	4																
8	5																
7A5	6F6	E	Parallel circuits only. Change socket to octal and rewire as follows. <div style="display: flex; align-items: center; justify-content: space-around;"> <div style="text-align: center;">  <p>ORIG.</p> </div> <table style="border: none;"> <tr> <td style="padding-right: 20px;">No. 1 on loctal</td> <td style="padding-right: 20px;">to No. 2 on octal</td> </tr> <tr> <td>2</td> <td>3</td> </tr> <tr> <td>3</td> <td>4</td> </tr> <tr> <td>6</td> <td>5</td> </tr> <tr> <td>7</td> <td>8</td> </tr> <tr> <td>8</td> <td>7</td> </tr> </table> <div style="text-align: center;">  <p>SUB.</p> </div> </div>	No. 1 on loctal	to No. 2 on octal	2	3	3	4	6	5	7	8	8	7		
No. 1 on loctal	to No. 2 on octal																
2	3																
3	4																
6	5																
7	8																
8	7																
	6K6	G															
	6L6	G															
	6U6	G															
	6V6	G															
	6Y6	G															
	7B5	G	Parallel circuits only. No changes.														
	7C5	G															
7A6	6H6	E	Reverse 6H6 to 7A6 procedure.														
	5679	E	No changes. Do not use unused terminals for anchor.														
7A7	6C6	G	Reverse 6C6 to 7A7 procedure.														
	6D6	E															
	77	G															
	78	E															
	6D7	G	Change socket to seven prong and rewire as follows: <div style="display: flex; align-items: center; justify-content: space-around;"> <div style="text-align: center;">  <p>ORIG.</p> </div> <table style="border: none;"> <tr> <td style="padding-right: 20px;">No. 1 on loctal</td> <td style="padding-right: 20px;">to No. 1 on seven prong</td> </tr> <tr> <td>2</td> <td>2</td> </tr> <tr> <td>3</td> <td>3</td> </tr> <tr> <td>4</td> <td>4</td> </tr> <tr> <td>6</td> <td>cap</td> </tr> <tr> <td>7</td> <td>6</td> </tr> <tr> <td>8</td> <td>7</td> </tr> </table> <div style="text-align: center;">  <p>SUB.</p> </div> </div>	No. 1 on loctal	to No. 1 on seven prong	2	2	3	3	4	4	6	cap	7	6	8	7
No. 1 on loctal	to No. 1 on seven prong																
2	2																
3	3																
4	4																
6	cap																
7	6																
8	7																
	6E7	G															
	6J7	G	Reverse 6K7 to 7A7 procedure														
	6K7	E															
	6S7	G	Parallel circuits only. Reverse 6K7 to 7A7 procedure.														
	6SH7	G	Reverse 12SJ7 to 7B7 procedure.														
	6SJ7	G															
	6SK7	E															

**7A7-7AB7**

**RECEIVING TUBE SUBSTITUTION GUIDE**

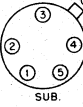





TUBE	SUB.	PERF.	CIRCUIT CHANGES NECESSARY														
7A7	6SS7	G	Parallel circuits only. Reverse 12SJ7 to 7B7 procedure.														
	6U7	G	Reverse to 6K7 to 7A7 procedure.														
	6W7	G	Parallel circuits only. Reverse to 6K7 to 7A7 procedure.														
	7B7	G	Parallel circuits only. No changes.														
	7C7	G															
	7H7	G	No changes.														
	7L7	G															
	39/44	E	Change socket to five prong and rewire as follows:														
			<table border="0"> <tr> <td>No. 1 on loctal</td> <td>to No. 1 on five prong</td> </tr> <tr> <td>2</td> <td>to 2</td> </tr> <tr> <td>3</td> <td>to 3</td> </tr> <tr> <td>4</td> <td>to 4</td> </tr> <tr> <td>6</td> <td>to cap</td> </tr> <tr> <td>7</td> <td>to 4</td> </tr> <tr> <td>8</td> <td>to 5</td> </tr> </table>	No. 1 on loctal	to No. 1 on five prong	2	to 2	3	to 3	4	to 4	6	to cap	7	to 4	8	to 5
No. 1 on loctal	to No. 1 on five prong																
2	to 2																
3	to 3																
4	to 4																
6	to cap																
7	to 4																
8	to 5																
			 														
7A8	6A7	E	Parallel circuits only. Reverse 6A7 to 7B8 procedure.														
	6A8	E	Parallel circuits only. Reverse 6D8 to 7A8 procedure.														
	6D8	G	Reverse 6D8 to 7A8 procedure.														
	7B8	E	Parallel circuits only. No changes.														
	7J8	G															
	7S7	G															
	7Q7	G	Parallel circuits only. Remove and tape up wires on No. 5. Connect Nos. 5 and 8 together.														
	12A8	P	Series circuits only. Reverse 12A8 to 14B8 procedure.														
	14B8	P	Series circuits only. No changes.														
	14J7	P															
	14S7	P															
7AB7	7AD7	P	Same as 7AB7 to 7AG7. Parallel circuits only.														
	7AJ7	P															
	7AK7	P															
	7G7	P															
	7H7	P															
	7L7	P															
	7T7	P															
	7V7	P															
	7AG7	G	Rewire as follows:														
	7AH7	G	Remove wires from No. 1														
	7B7	G	No. 2 to No. 1														
	7C7	G	3 to 2														
			Connect wires removed from No. 1 to No. 3														
			Remove wires from No. 8														
			No. 7 to No. 8														
			6 to 7														
			5 to 6														
			Connect wires removed from No. 8 to No. 7														
			Connect No. 4 and No. 7 together.														

RECEIVING TUBE SUBSTITUTION GUIDE

7AB7-7AK7

TUBE	SUB.	PERF.	CIRCUIT CHANGES NECESSARY
7AB7	1204	E	No changes.
7AD7	7AG7	P	Parallel circuits only. No changes.
	7AH7	P	
	7AJ7	P	
	7AK7	P	
	7B7	P	
	7C7	P	
	7G7	P	
	7H7	P	
	7L7	P	
	7T7	P	
7V7	P		
7AF7	7F7	G	No changes.
	7N7	G	Parallel circuits only. No changes.
7AG7	7AH7	G	No changes.
	7B7	P	
	7C7	P	
	7AJ7	P	Parallel circuits only. No changes.
	7AK7	P	
	7G7	G	
	7H7	G	
	7L7	G	
	7T7	G	
	7V7	G	
7AH7	7AG7	G	
	7B7	P	
	7C7	P	
	7AJ7	G	Parallel circuits only. No changes.
	7AK7	P	
	7G7	P	
	7H7	P	
	7L7	P	
	7T7	P	
	7V7	P	
7AJ7	7AH7	G	Parallel circuits only. No changes.
	7AK7	P	
	7B7	P	
	7C7	P	
	7G7	P	
	7V7	P	
	7H7	P	
	7L7	P	
	7T7	P	
	7AK7	7AH7	
7AJ7		P	
7B7		P	
7C7		P	
7G7		P	
7H7		P	
7L7		P	
7T7		P	
7V7		P	

## RECEIVING TUBE SUBSTITUTION GUIDE

TUBE	SUB.	PERF.	CIRCUIT CHANGES NECESSARY																		
7B4	6AD5	G	Reverse 6J5 to 7A4 procedure.																		
	6AE5	G																			
	6F5	G	Change socket to octal and rewire as follows.																		
			<table border="0"> <tr> <td></td> <td>No. 1 on loctal</td> <td>to No. 2 on octal</td> </tr> <tr> <td></td> <td>2</td> <td>to 4</td> </tr> <tr> <td></td> <td>6</td> <td>to cap</td> </tr> <tr> <td></td> <td>7</td> <td>to 8</td> </tr> <tr> <td></td> <td>8</td> <td>to 7</td> </tr> </table>		No. 1 on loctal	to No. 2 on octal		2	to 4		6	to cap		7	to 8		8	to 7			
	No. 1 on loctal	to No. 2 on octal																			
	2	to 4																			
	6	to cap																			
	7	to 8																			
	8	to 7																			
	6J5	G	Reverse 6J5 to 7A4 procedure.																		
	6K5	G	Reverse 6K5 to 7B4 procedure.																		
	6P5	G	Reverse 6J5 to 7A4 procedure.																		
	7A4	G	No changes.																		
	XXL	G																			
7B5	6AD7	G	Parallel circuits only. Reverse 6K6 to 7B5 procedure. Remove and tape up any wires anchored on unused pins.																		
	6F6	G																			
	6K6	E																			
	6L6	G																			
	6U6	G																			
	6V6	G																			
	6Y6	G																			
	7A5	G																			
	7C5	G																			
	41	G																			
	42	E																			
					Change socket to six prong and rewire as follows:																
			<table border="0"> <tr> <td></td> <td>No. 1 on loctal</td> <td>to No. 1 on six prong</td> </tr> <tr> <td></td> <td>2</td> <td>to 2</td> </tr> <tr> <td></td> <td>3</td> <td>to 3</td> </tr> <tr> <td></td> <td>6</td> <td>to 4</td> </tr> <tr> <td></td> <td>7</td> <td>to 5</td> </tr> <tr> <td></td> <td>8</td> <td>to 6</td> </tr> </table>		No. 1 on loctal	to No. 1 on six prong		2	to 2		3	to 3		6	to 4		7	to 5		8	to 6
	No. 1 on loctal	to No. 1 on six prong																			
	2	to 2																			
	3	to 3																			
	6	to 4																			
	7	to 5																			
	8	to 6																			
7B6	6B6	E	Reverse 6B6 to 7B6 procedure.																		
	6Q7	E	Reverse 6Q7 to 7B6 procedure.																		
	6R7	G																			
	6SQ7	E	Reverse 6SQ7 to 7B6 procedure.																		
	6T7	G	Parallel circuits only. Reverse 6Q7 to 7B6 procedure.																		
	7C6	G	Parallel circuits only. No changes.																		
	7E6	G	No changes.																		
	75	E	Reverse 75 to 7E6 procedure.																		
	85	G	Reverse 75 to 7E6 procedure.																		
	7B7	6C6	G	Parallel circuits only. Reverse 6C6 to 7A7 procedure.																	
6D6		G																			

## RECEIVING TUBE SUBSTITUTION GUIDE

7B7-7C4

TUBE	SUB.	PERF.	CIRCUIT CHANGES NECESSARY
7B7	6D7	G	Same as 7A7 to 6D7. Parallel circuits only.
	6E7	G	
	6J7	G	Parallel circuits only. Reverse 6J7 to 7L7 procedure.
	6K7	G	Parallel circuits only. Reverse 6K7 to 7A7 procedure.
	6S7	G	Reverse 6K7 to 7A7 procedure.
	6SH7	G	Parallel circuits only. Reverse 12SJ7 to 7B7 procedure.
	6SJ7	G	
	6SK7	G	
	6SS7	G	Reverse 12SJ7 to 7B7 procedure.
	6U7	G	Parallel circuits only. Reverse 6K7 to 7A7 procedure.
	6W7	G	Reverse 6K7 to 7A7 procedure.
	7A7	G	Parallel circuits only. No changes.
	7C7	G	No changes.
	7H7	G	Parallel circuits only. No changes.
	12J7	P	Series circuits only. Reverse 6K7 to 7A7 procedure.
	12K7	P	
	12SG7	P	Series circuits only. Reverse 12SJ7 to 7B7 procedure.
	12SH7	P	
	12SJ7	P	
	12SK7	P	
14A7/12B7	P	Series circuits only. No changes.	
39/44	G	Same as 7A7 to 39/44. Parallel circuits only.	
77	G	Parallel circuits only. Reverse 6C6 to 7A7 procedure.	
78	G		
7B8	6A7	G	Reverse 6A7 to 7B8 procedure.
	6A8	G	Reverse as 12A8 to 14B8 procedure.
	6D8	G	Parallel circuits only. Reverse 12A8 to 14B8 procedure.
	6J8	E	Reverse 12A8 to 14B8 procedure.
	6K8	E	
	7A8	G	Parallel circuits only. No changes.
	7J7	G	No changes.
	7S7	G	No changes.
7C4	1203A	E	No changes.
	9006	G	Change socket to miniature and rewire as follows:



No. 1 on octal		to No. 3 on miniature
4		1
7		7
8		4

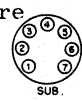

## 7C5-7C7

## RECEIVING TUBE SUBSTITUTION GUIDE

TUBE	SUB.	PERF.	CIRCUIT CHANGES NECESSARY
7C5	6AD7	G	Parallel circuits only. Reverse 6K6 to 7B5 procedure. Do not anchor on unused pins.
	6F6	G	Parallel circuits only. Reverse 6K6 to 7B5 procedure.
	6G6	G	
	6K6	G	
	6L6	G	
	6U6	G	
	6V6	E	
	6Y6	G	
	7A5	G	Parallel circuits only. No changes.
	7B5	G	Parallel circuits only. No changes.
	41	G	Same as 7B5 to 41. Parallel circuits only.
	42	G	
	7C6	6B6	G
6Q7		G	
6R7		G	
6SQ7		G	Parallel circuits only. Reverse 6SQ7 to 7B6 procedure.
6ST7		G	Reverse 6SQ7 to 7B6 procedure.
6T7		G	
7B6		G	Parallel circuits only. No changes.
12Q7		P	Series circuits only. Reverse 6Q7 to 7B6 procedure.
12SQ7		P	Series circuits only. Reverse 6SQ7 to 7B6 procedure.
12SR7		P	
14B6		P	Series circuits only. No changes.
14E6		P	
75		G	Parallel circuits only. Reverse 75 to 7E6 procedure.
85	G		
7C7	6C6	G	Parallel circuits only. Reverse 6C6 to 7A7 procedure.
	6D6	G	
	77	G	
	78	G	
	6D7	G	Same as 7A7 to 6D7. Parallel circuits only.
	6E7	G	
	6S7	G	Reverse 6K7 to 7A7 procedure.
	6SS7	G	Reverse 12SJ7 to 7B7 procedure.
	6W7	G	Reverse 6K7 to 7A7 procedure.
	7A7	G	Parallel circuits only. No changes.
	7B7	G	No changes.
	7H7	G	Parallel circuits only. No changes.



RECEIVING TUBE SUBSTITUTION GUIDE

7C7-7F7

TUBE	SUB.	PERF.	CIRCUIT CHANGES NECESSARY
7C7	12J7	P	Series circuits only. Reverse 6K7 to 7A7 procedure.
	12K7	P	
	12SG7	P	Series circuits only. Reverse 12SJ7 to 7B7 procedure.
	12SH7	P	
	12SJ7	P	
	12SK7	P	
	14A7/12B7	P	Series circuits only. No changes.
	36	G	Same as 7A7 to 39/44. Parallel circuits only.
	39/44	G	
7D7			No practical substitute.
7E5	7A4	P	Parallel circuits only. Rewire as follows: Remove wires from No. 1
	7B4	P	
			No. 2 to No. 1
			3 and 7 to 2
			4 and 6 to 7
			5 to 6
			Connect wires removed from No. 1 to No. 6
	1201	E	No changes.
7E6	6B6	G	Reverse 6Q7 to 7B6 procedure.
	6Q7	G	
	6R7	G	Reverse 6Q7 to 7B6 procedure.
	6SQ7	G	Reverse 6SQ7 to 7B6 procedure.
	6SR7	G	Reverse 6SQ7 to 7B6 procedure.
	6T7	G	Parallel circuits only. Reverse 6Q7 to 7B6 procedure.
	75	G	Reverse 75 to 7E6 procedure.
	85	G	Reverse 75 to 7E6 procedure.
	7B6	G	No changes.
	7C6	G	Parallel circuits only. No changes.
7E7	6B8	G	Reverse 6B8 to 7E7 procedure.
	7R7	G	No changes.
7F7	6C8	G	Reverse 6C8 to 7F7 procedure.
	6F8	G	Parallel circuits only. Reverse 6C8 to 7F7 procedure.
	6SC7	G	Reverse 6SC7 to 7F7 procedure.
	6SL7	G	Reverse 6SL7 to 7F7 procedure.
	7AF7	G	No changes.
	7F8	G	Reverse 7F8 to 7F7 procedure.
	7N7	G	Parallel circuits only. No changes.

7F8-7J7

RECEIVING TUBE SUBSTITUTION GUIDE

TUBE	SUB.	PERF.	CIRCUIT CHANGES NECESSARY
7F8	2C51	P	Reverse 2C51 to 7F8 procedure.
	6F8	P	Parallel circuits only. Change socket to octal and rewire as follows: No. 1 on loctal to cap on octal 2 to 2 3 to 3 4 to 4 5 to 8 6 to 6 7 to 7 8 to 5
			 
	7AF7	P	Same as 7F8 to 7F7.
	7F7	P	Rewire as follows: Remove wires from No. 1 No. 2 to No. 1 4 to 2 Connect wires removed from No. 1 to No. 4 Remove wires from No. 8 No. 7 to No. 8 5 to 7 Connect wires removed from No. 8 to No. 5
	7N7	P	Same as 7F8 to 7F7. Parallel circuits only.
	5670	E	Parallel circuits only. Reverse 2C51 to 7F8 procedure.
7G7	7A7	G	Parallel circuits only. No changes.
	7B7	G	
	7C7	G	
	7H7	G	
	7L7	G	
	7V7	G	No changes.
	1232	G	Parallel circuits only. No changes.
7G7/1232	6J7	G	Parallel circuits only. Reverse 6J7 procedure.
	6K7	G	
	6U7	G	
7H7	7A7	G	No changes.
	7B7	G	Parallel circuits only. No changes.
	7C7	G	
	7L7	G	No changes.
	7T7	G	
	7V7	G	Parallel circuits only. No changes.
	1231	G	
	1273	G	No changes.
7J7	6A8	E	Reverse 6J8 to 7J7 procedure.
	6J8	E	
	6K8	E	
	7B8	G	No changes.
	7S7	G	



# RECEIVING TUBE SUBSTITUTION GUIDE

7K7-7T7

TUBE	SUB.	PERF.	CIRCUIT CHANGES NECESSARY					
7K7	7B6	G	Rewire as follows:					
	7E6	G		<table style="margin-left: 20px;"> <tr> <td>No. 2</td> <td>to No. 7</td> </tr> <tr> <td>3</td> <td>to 2</td> </tr> <tr> <td>4</td> <td>to 3</td> </tr> </table>	No. 2	to No. 7	3	to 2
No. 2	to No. 7							
3	to 2							
4	to 3							
	7X7	G	Rewire as follows: Remove wires from No. 2 No. 3 to No. 2 4 to 3 Connect wires removed from No. 2 to No. 4					
7L7	6J7	G	Reverse 6J7 to 7L7 procedure.					
	6K7	G	Reverse 6K7 to 7A7 procedure.					
	7A7	G	No changes.					
	7G7	G	Parallel circuits only. No changes.					
	7H7	G	No changes.					
	7T7	G	No changes.					
	7V7	G	Parallel circuits only. No changes.					
7N7	6C8	G	Parallel circuits only. Reverse 6C8 to 7F7 procedure.					
	6F8	G	Reverse 6C8 to 7F7 procedure.					
	7AF7	G	Parallel circuits only. No changes.					
	7F7	G	Parallel circuits only. No changes.					
7Q7	6SA7	G	Reverse 12SA7 to 14Q7 procedure.					
7R7	7E7	G	No changes.					
7S7	6A7	G	Reverse 6A7 to 7B8 procedure.					
	6A8	G						
	6J8	G	Reverse 6J8 to 7J7 procedure.					
	6K8	G						
	7B8	G	No changes.					
	7J7	G						
7T7	7A7	G	No changes.					
	7B7	G	Parallel circuits only. No changes.					
	7C7	G	Parallel circuits only. No changes.					
	7G7	G	Parallel circuits only. No changes.					
	7H7	G	No changes.					
	7L7	G	No changes.					
	7V7	G	No changes.					
	1231	G	Parallel circuits only. No changes.					







## 7T7-12A

## RECEIVING TUBE SUBSTITUTION GUIDE

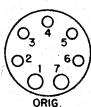
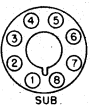
TUBE	SUB.	PERF.	CIRCUIT CHANGES NECESSARY
7T7	1273	G	No changes.
7V7	7B7 7C7	G G	Parallel circuits only. No changes.
	7G7 1232	G G	No changes.
	7W7	E	Rewire as follows: No. 4 to No. 5 Do not use No. 4 for anchor
7W7	7V7	E	Rewire as follows: No. 4 to No. 7 5 to 4
7X6	7Y4 7Z4	G G	Parallel circuits only. Rewire as follows: Connect Nos. 2 and 7 together. Cannot be used where 7X6 is employed as a doubler.
7X7	7K7	G	Rewire as follows: Remove wires from No. 2 No. 4 to No. 2 3 to 4 Connect wires removed from No. 2 to No. 3
	XXFM	E	No changes.
7Y4	6X5	E	Reverse 6X5 to 7Y4 procedure.
	7X6	G	Parallel circuits only. No changes. If it is convenient, connect No. 2 and 7 together.
	7Z4	G	Parallel circuits only. No changes.
7Z4	6W5 6X5 6ZY5	G E G	Parallel circuits only. Reverse 6X5 to 7Y4 procedure.
	7X6	G	No changes. If it is convenient, connect Nos. 2 and 7 together.
	7Y4	G	Parallel circuits only. No changes.
10	10Y RK10 50 210 310	E E G E E	No changes
10Y	10 RK10 50 210 310	E E G E E	No changes.
12A	71A	G	No changes.

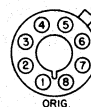
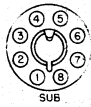
RECEIVING TUBE SUBSTITUTION GUIDE

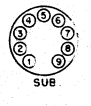
12A5-12AL5

TUBE	SUB.	PERF.	CIRCUIT CHANGES NECESSARY																
12A5	12A6	G	12 volt operation only. Parallel circuits only. Change socket to octal and rewire as follows: <table style="margin-left: 40px;"> <tr> <td>No. 1 on seven prong</td> <td>to No. 2 on octal</td> </tr> <tr> <td>2</td> <td>to 3</td> </tr> <tr> <td>3</td> <td>to 4</td> </tr> <tr> <td>4</td> <td>to 5</td> </tr> <tr> <td>5</td> <td>to 8</td> </tr> <tr> <td>7</td> <td>to 7</td> </tr> </table>  	No. 1 on seven prong	to No. 2 on octal	2	to 3	3	to 4	4	to 5	5	to 8	7	to 7				
No. 1 on seven prong	to No. 2 on octal																		
2	to 3																		
3	to 4																		
4	to 5																		
5	to 8																		
7	to 7																		
12A6	6G6	P	No changes. Series circuits.																
	14A5	G	Same as 35L6 to 35A5.																
12A8	12K8	G	No changes.																
	14A7/12B7	P	Change socket to loctal and rewire as follows: <table style="margin-left: 40px;"> <tr> <td>No. 2 on octal</td> <td>to No. 1 on loctal</td> </tr> <tr> <td>3</td> <td>to 2</td> </tr> <tr> <td>5</td> <td>to 6</td> </tr> <tr> <td>6</td> <td>to 3</td> </tr> <tr> <td>7</td> <td>to 8</td> </tr> <tr> <td>8</td> <td>to 7</td> </tr> <tr> <td>cap</td> <td>to 4</td> </tr> </table>   <p style="margin-left: 40px;">Must be well shielded. Realign if necessary</p>	No. 2 on octal	to No. 1 on loctal	3	to 2	5	to 6	6	to 3	7	to 8	8	to 7	cap	to 4		
No. 2 on octal	to No. 1 on loctal																		
3	to 2																		
5	to 6																		
6	to 3																		
7	to 8																		
8	to 7																		
cap	to 4																		
	14B8	G	Change socket to loctal and rewire as follows:																
	14J7	G	<table style="margin-left: 40px;"> <tr> <td>No. 2 on octal</td> <td>to No. 1 on loctal</td> </tr> <tr> <td>3</td> <td>to 2</td> </tr> <tr> <td>4</td> <td>to 5</td> </tr> <tr> <td>5</td> <td>to 4</td> </tr> <tr> <td>6</td> <td>to 3</td> </tr> <tr> <td>7</td> <td>to 8</td> </tr> <tr> <td>8</td> <td>to 7</td> </tr> <tr> <td>cap</td> <td>to 6</td> </tr> </table>  	No. 2 on octal	to No. 1 on loctal	3	to 2	4	to 5	5	to 4	6	to 3	7	to 8	8	to 7	cap	to 6
No. 2 on octal	to No. 1 on loctal																		
3	to 2																		
4	to 5																		
5	to 4																		
6	to 3																		
7	to 8																		
8	to 7																		
cap	to 6																		
	14S7	G																	
12AH7	12AT7	G	Change socket to noval and rewire as follows: <table style="margin-left: 40px;"> <tr> <td>No. 1 on octal</td> <td>to No. 2 on noval</td> </tr> <tr> <td>2</td> <td>to 3</td> </tr> <tr> <td>3</td> <td>to 1</td> </tr> <tr> <td>4</td> <td>to 8</td> </tr> <tr> <td>5</td> <td>to 7</td> </tr> <tr> <td>6</td> <td>to 6</td> </tr> <tr> <td>7</td> <td>to 5</td> </tr> <tr> <td>8</td> <td>to 4</td> </tr> </table>  	No. 1 on octal	to No. 2 on noval	2	to 3	3	to 1	4	to 8	5	to 7	6	to 6	7	to 5	8	to 4
No. 1 on octal	to No. 2 on noval																		
2	to 3																		
3	to 1																		
4	to 8																		
5	to 7																		
6	to 6																		
7	to 5																		
8	to 4																		
	14AF7/XXD	G	Change socket to loctal and rewire as follows:																
	14F7	G	<table style="margin-left: 40px;"> <tr> <td>No. 1 on octal</td> <td>to No. 4 on loctal</td> </tr> <tr> <td>2</td> <td>to 2</td> </tr> <tr> <td>3</td> <td>to 3</td> </tr> <tr> <td>4</td> <td>to 7</td> </tr> <tr> <td>5</td> <td>to 5</td> </tr> <tr> <td>6</td> <td>to 6</td> </tr> <tr> <td>7</td> <td>to 8</td> </tr> <tr> <td>8</td> <td>to 1</td> </tr> </table>  	No. 1 on octal	to No. 4 on loctal	2	to 2	3	to 3	4	to 7	5	to 5	6	to 6	7	to 8	8	to 1
No. 1 on octal	to No. 4 on loctal																		
2	to 2																		
3	to 3																		
4	to 7																		
5	to 5																		
6	to 6																		
7	to 8																		
8	to 1																		
12AL5	12H6	G	Where space permits. Same as 6AL5 to 6H6.																

**12AT6-12AY7**



**RECEIVING TUBE SUBSTITUTION GUIDE**

TUBE	SUB.	PERF.	CIRCUIT CHANGES NECESSARY	
12AT6	12AV6	G	No changes.	
	12BF6	P		
	12BK6	G		
	12BT6	P		
	12BU6	P		
	12SQ7	12SQ7	G	Where space permits. Reverse 12SQ7 to 12AT6 procedure.
		12SR7	P	
		12SW7	P	
	12AT7 *	12AH7	G	Where space permits. Reverse 12AH7 to 12AT7 procedure.
		12AU7	G	No changes.
12AV7		G	Parallel circuits only. No changes.	
12AX7.		G	No changes.	
12AY7		G		
12BH7		G	Parallel circuits only. No changes.	
12AU6		12AW6	G	Reverse Nos. 2 and 7.
	12BA6	G	No changes.	
	12BD6	G		
12AU7 *	12AT7	G	No changes.	
	12AV7	G	Parallel circuits only. No changes.	
	12AX7	G	No changes.	
	12AY7	G		
12AV6	12AT6	G	No changes.	
	12BF6	P		
	12BK6	G		
	12BT6	G		
	12BU6	G		
12AV7	12AT7	G	Parallel circuits only. No changes.	
	12AU7	G		
	12AX7	G		
	12AY7	G		
	12BH7	G		
12AW6	12AU6	G	Rewire as follows: Reverse No. 2 and No. 7	
	12BA6	G		
12AX7	12AT7	G	No changes.	
	12AU7	G		
	12AV7	G	Parallel circuits only. No changes.	
	12AY7	G	No changes.	
	12BH7	G	Parallel circuits only. No changes.	
12AY7	12AT7	G	No changes.	
	12AU7	G		
	12AV7	G	Parallel circuits only. No changes.	

\* See Addendum at back of this section.



## RECEIVING TUBE SUBSTITUTION GUIDE

12AY7-12BT6

TUBE	SUB.	PERF.	CIRCUIT CHANGES NECESSARY																
12AY7	12AX7	G	No changes.																
	12BH7	G	Parallel circuits only. No changes.																
12B6M			No practical substitute.																
12B7	14A7	E	No changes.																
12B8GT			No practical substitute.																
12BA6	12AU6	G	No changes.																
	12AV6	G	Reverse 12AW6 to 12AU6 procedure.																
	12AW6	G																	
12BA7	12BE6	G	Change socket to miniature and rewire as follows:																
			<table border="0" style="margin-left: auto; margin-right: auto;"> <tr> <td style="text-align: center;">No. 1 on noval</td> <td style="text-align: center;">to No. 6 on miniature</td> </tr> <tr> <td style="text-align: center;">2</td> <td style="text-align: center;">to 1</td> </tr> <tr> <td style="text-align: center;">3</td> <td style="text-align: center;">to 2</td> </tr> <tr> <td style="text-align: center;">4</td> <td style="text-align: center;">to 3</td> </tr> <tr> <td style="text-align: center;">5</td> <td style="text-align: center;">to 4</td> </tr> <tr> <td style="text-align: center;">6</td> <td style="text-align: center;">to 2</td> </tr> <tr> <td style="text-align: center;">7</td> <td style="text-align: center;">to 7</td> </tr> <tr> <td style="text-align: center;">9</td> <td style="text-align: center;">to 5</td> </tr> </table>	No. 1 on noval	to No. 6 on miniature	2	to 1	3	to 2	4	to 3	5	to 4	6	to 2	7	to 7	9	to 5
No. 1 on noval	to No. 6 on miniature																		
2	to 1																		
3	to 2																		
4	to 3																		
5	to 4																		
6	to 2																		
7	to 7																		
9	to 5																		
			 																
12BD6	12AU6	G	No changes.																
	12AW6	G	Rewire as follows: Reverse No. 7 and No. 2																
	12BA6	G	No changes.																
12BE6	12BA7	G	Same as 6BE6 to 6BA7.																
	12SA7	G	Where space permits. Reverse 12SA7 to 12BE6 procedure.																
12BF6	12AT6	P	No changes.																
	12AV6	P																	
	12BK6	P																	
	12BT6	P																	
	12BU6	G																	
12BH7	12AT7	G	Parallel circuits only. No changes.																
	12AU7	G																	
	12AV7	G																	
	12AX7	G																	
	12AY7	G																	
12BK6	12AT6	G	No changes.																
	12AV6	G																	
	12BF6	P																	
	12BT6	G																	
	12BU6	G																	
12BT6	12AT6	G	No changes.																
	12AV6	G																	
	12BF6	P																	
	12BK6	G																	
	12BU6	G																	

12BU6-12K7

RECEIVING TUBE SUBSTITUTION GUIDE

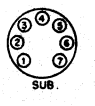
TUBE	SUB.	PERF.	CIRCUIT CHANGES NECESSARY																
12BU6	12AT6 12AV6 12BF6 12BK6 12BT6	P P G P P	No changes.																
12C8	14E7 14R7	G G	Change socket to loctal and rewire as follows: <table border="0"> <tr> <td>No. 2 on octal</td> <td>to No. 1 on loctal</td> </tr> <tr> <td>3</td> <td>to 2</td> </tr> <tr> <td>4</td> <td>to 3</td> </tr> <tr> <td>5</td> <td>to 4</td> </tr> <tr> <td>6</td> <td>to 5</td> </tr> <tr> <td>7</td> <td>to 8</td> </tr> <tr> <td>8</td> <td>to 7</td> </tr> <tr> <td>cap</td> <td>to 6</td> </tr> </table>  	No. 2 on octal	to No. 1 on loctal	3	to 2	4	to 3	5	to 4	6	to 5	7	to 8	8	to 7	cap	to 6
No. 2 on octal	to No. 1 on loctal																		
3	to 2																		
4	to 3																		
5	to 4																		
6	to 5																		
7	to 8																		
8	to 7																		
cap	to 6																		
12E5	1626	G	Parallel circuits only. No changes.																
12F5	12J5	G	Rewire as follows: No. 4 to No. 3. Connect grid wire to No. 5.																
	12SF5	E	Same as 6F5 to 6SF5.																
12G7G			No practical substitute.																
12H6	12AL5	E	Change socket to miniature and rewire as follows: <table border="0"> <tr> <td>No. 2 on octal</td> <td>to No. 3 on miniature</td> </tr> <tr> <td>3</td> <td>to 2</td> </tr> <tr> <td>4</td> <td>to 5</td> </tr> <tr> <td>5</td> <td>to 7</td> </tr> <tr> <td>7</td> <td>to 4</td> </tr> <tr> <td>8</td> <td>to 1</td> </tr> </table>  	No. 2 on octal	to No. 3 on miniature	3	to 2	4	to 5	5	to 7	7	to 4	8	to 1				
No. 2 on octal	to No. 3 on miniature																		
3	to 2																		
4	to 5																		
5	to 7																		
7	to 4																		
8	to 1																		
12J5	12F5	G	Rewire as follows: No. 3 to No. 4 Connect wire from No. 5 to grid cap.																
	12SF5	G	Same as 12SF5 to 12J5.																
	14A4	G	Same as 6J5 to 7A4.																
	1626	G	Parallel circuits only. No changes.																
12J7	6S7 6W7	P P	Series circuits only. No changes.																
	7B7 7C7 12B7	P P E	Same as 12K7 to 7B7 but in series circuits only.																
	12K7	G	No changes.																
	12SG7 12SH7 12SJ7 12SK7	G G E G	Same as 12K7 to 12SK7.																
	14A7	E	Same as 12K7 to 7B7 but in series circuits only.																
12K7	6S7	P	Series circuits only. No changes.																

RECEIVING TUBE SUBSTITUTION GUIDE

12K7-12SA7

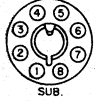
TUBE	SUB.	PERF.	CIRCUIT CHANGES NECESSARY																
12K7	6SS7	G	Same as 12K7 to 12SK7. Series circuits only.																
	6W7	E	Series circuits only. No changes.																
	7B7	P	Change socket to loctal and rewire as follows, series circuits only: <table border="0" style="margin-left: 40px;"> <tr> <td style="text-align: center;">No. 1 on octal</td> <td style="text-align: center;">to No. 5 on loctal</td> </tr> <tr> <td style="text-align: center;">2</td> <td style="text-align: center;">to 1</td> </tr> <tr> <td style="text-align: center;">3</td> <td style="text-align: center;">to 2</td> </tr> <tr> <td style="text-align: center;">4</td> <td style="text-align: center;">to 3</td> </tr> <tr> <td style="text-align: center;">5</td> <td style="text-align: center;">to 4</td> </tr> <tr> <td style="text-align: center;">7</td> <td style="text-align: center;">to 8</td> </tr> <tr> <td style="text-align: center;">8</td> <td style="text-align: center;">to 7</td> </tr> <tr> <td style="text-align: center;">cap</td> <td style="text-align: center;">to 6</td> </tr> </table>	No. 1 on octal	to No. 5 on loctal	2	to 1	3	to 2	4	to 3	5	to 4	7	to 8	8	to 7	cap	to 6
	No. 1 on octal	to No. 5 on loctal																	
	2	to 1																	
3	to 2																		
4	to 3																		
5	to 4																		
7	to 8																		
8	to 7																		
cap	to 6																		
7C7	P																		
12B7	E																		
14A7	E																		
14C7	E																		
			 																
	12J7	G	No changes.																
	12SK7	E	Make adaptor as follows: <table border="0" style="margin-left: 40px;"> <tr> <td style="text-align: center;">No. 1 on base</td> <td style="text-align: center;">to No. 1 on top</td> </tr> <tr> <td style="text-align: center;">2</td> <td style="text-align: center;">to 2</td> </tr> <tr> <td style="text-align: center;">3</td> <td style="text-align: center;">to 8</td> </tr> <tr> <td style="text-align: center;">4</td> <td style="text-align: center;">to 6</td> </tr> <tr> <td style="text-align: center;">5</td> <td style="text-align: center;">to 3</td> </tr> <tr> <td style="text-align: center;">7</td> <td style="text-align: center;">to 7</td> </tr> <tr> <td style="text-align: center;">8</td> <td style="text-align: center;">to 5</td> </tr> <tr> <td style="text-align: center;">cap</td> <td style="text-align: center;">to 4</td> </tr> </table>	No. 1 on base	to No. 1 on top	2	to 2	3	to 8	4	to 6	5	to 3	7	to 7	8	to 5	cap	to 4
No. 1 on base	to No. 1 on top																		
2	to 2																		
3	to 8																		
4	to 6																		
5	to 3																		
7	to 7																		
8	to 5																		
cap	to 4																		
12K8	12A8	G	No changes.																
	14B8	G	Same as 12A8 to 14B8.																
	14J7	G																	
	14S7	G																	
12L8	1644	G	No changes.																
12Q7	6ST7	P	Same as 12Q7 to 12SQ7. Series circuits only.																
	6T7	P	Series circuits only. No changes.																
	7C6	P	Series circuits only. Same as 6Q7 to 7B6.																
	14B6	E																	
	14E6	G																	
	12SQ7	E	Make adaptor as follows: <table border="0" style="margin-left: 40px;"> <tr> <td style="text-align: center;">No. 1 on base</td> <td style="text-align: center;">to No. 1 on top</td> </tr> <tr> <td style="text-align: center;">2</td> <td style="text-align: center;">to 8</td> </tr> <tr> <td style="text-align: center;">3</td> <td style="text-align: center;">to 6</td> </tr> <tr> <td style="text-align: center;">4</td> <td style="text-align: center;">to 4</td> </tr> <tr> <td style="text-align: center;">5</td> <td style="text-align: center;">to 5</td> </tr> <tr> <td style="text-align: center;">7</td> <td style="text-align: center;">to 7</td> </tr> <tr> <td style="text-align: center;">8</td> <td style="text-align: center;">to 3</td> </tr> </table>	No. 1 on base	to No. 1 on top	2	to 8	3	to 6	4	to 4	5	to 5	7	to 7	8	to 3		
No. 1 on base	to No. 1 on top																		
2	to 8																		
3	to 6																		
4	to 4																		
5	to 5																		
7	to 7																		
8	to 3																		
12SA7	6SS7	P	Same as 12SA7 to 12SK7 series circuits.																



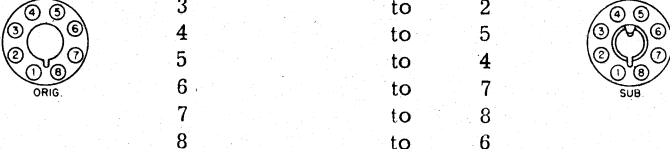
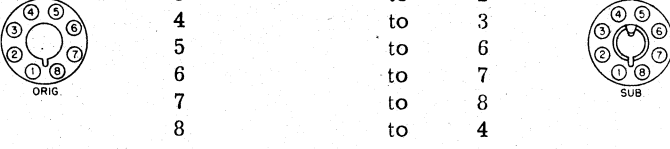
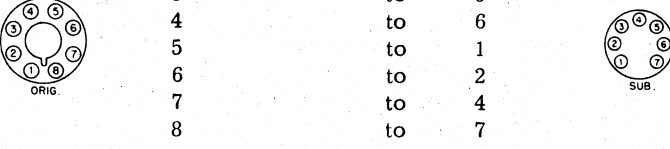
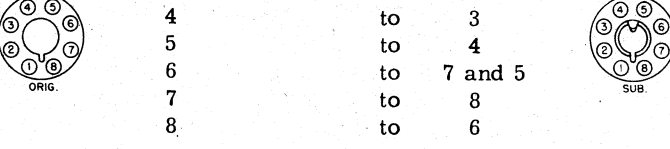

RECEIVING TUBE SUBSTITUTION GUIDE







TUBE	SUB.	PERF.	CIRCUIT CHANGES NECESSARY														
12SA7	7A8	P	<p>Series circuits only. Change socket to loctal and rewire as follows:                      No. 1 on octal to shield connection on loctal socket</p> <table border="0"> <tr> <td>2</td> <td>to No. 1</td> </tr> <tr> <td>3</td> <td>to 2</td> </tr> <tr> <td>4</td> <td>to 5</td> </tr> <tr> <td>5</td> <td>to 4</td> </tr> <tr> <td>6</td> <td>to 7</td> </tr> <tr> <td>7</td> <td>to 8</td> </tr> <tr> <td>8</td> <td>to 6</td> </tr> </table>  <p>The 7A8 heats faster than the other tubes and a 200 ohm 1/2 watt resistor must be connected across the filament terminals 2 and 7 or its life will be very short.</p>	2	to No. 1	3	to 2	4	to 5	5	to 4	6	to 7	7	to 8	8	to 6
2	to No. 1																
3	to 2																
4	to 5																
5	to 4																
6	to 7																
7	to 8																
8	to 6																
7B7		P	<p>Series circuits only. Change socket to loctal and rewire as follows:</p> <table border="0"> <tr> <td>No. 2 on octal</td> <td>to No. 1 on loctal</td> </tr> <tr> <td>3</td> <td>to 2</td> </tr> <tr> <td>4</td> <td>to 3</td> </tr> <tr> <td>5</td> <td>to 6</td> </tr> <tr> <td>6</td> <td>to 7</td> </tr> <tr> <td>7</td> <td>to 8</td> </tr> <tr> <td>8</td> <td>to 4</td> </tr> </table> 	No. 2 on octal	to No. 1 on loctal	3	to 2	4	to 3	5	to 6	6	to 7	7	to 8	8	to 4
No. 2 on octal	to No. 1 on loctal																
3	to 2																
4	to 3																
5	to 6																
6	to 7																
7	to 8																
8	to 4																
7C7		P															
12B7/14A7		P															
12BE6		G	<p>Change socket to miniature and rewire as follows:</p> <table border="0"> <tr> <td>No. 2 on octal</td> <td>to No. 3 on miniature</td> </tr> <tr> <td>3</td> <td>to 5</td> </tr> <tr> <td>4</td> <td>to 6</td> </tr> <tr> <td>5</td> <td>to 1</td> </tr> <tr> <td>6</td> <td>to 2</td> </tr> <tr> <td>7</td> <td>to 4</td> </tr> <tr> <td>8</td> <td>to 7</td> </tr> </table> 	No. 2 on octal	to No. 3 on miniature	3	to 5	4	to 6	5	to 1	6	to 2	7	to 4	8	to 7
No. 2 on octal	to No. 3 on miniature																
3	to 5																
4	to 6																
5	to 1																
6	to 2																
7	to 4																
8	to 7																
12J7		P	<p>Make adaptor as follows:</p> <table border="0"> <tr> <td>No. 1 on base</td> <td>to No. 1 on top</td> </tr> <tr> <td>2</td> <td>to 2</td> </tr> <tr> <td>3</td> <td>to 3</td> </tr> <tr> <td>4</td> <td>to 4</td> </tr> <tr> <td>5</td> <td>to cap</td> </tr> <tr> <td>6</td> <td>to 8</td> </tr> <tr> <td>8</td> <td>to 5</td> </tr> </table>	No. 1 on base	to No. 1 on top	2	to 2	3	to 3	4	to 4	5	to cap	6	to 8	8	to 5
No. 1 on base	to No. 1 on top																
2	to 2																
3	to 3																
4	to 4																
5	to cap																
6	to 8																
8	to 5																
12K7		P															
12SJ7		P	<p>Change connections as follows:                      Reverse Nos. 8 and 3                      Remove wire from No. 6                      Move wire from No. 4 to 6                          from 5 to 4                          from 6 to 5</p> <p>This uses suppressor grid as control grid and control as oscillator grid.</p>														
12SK7		P															
14Q7		G	<p>Change socket to loctal and rewire as follows:</p> <table border="0"> <tr> <td>No. 2 on octal</td> <td>to No. 1 on loctal</td> </tr> <tr> <td>3</td> <td>to 2</td> </tr> <tr> <td>4</td> <td>to 3</td> </tr> <tr> <td>5</td> <td>to 4</td> </tr> <tr> <td>6</td> <td>to 7 and 5</td> </tr> <tr> <td>7</td> <td>to 8</td> </tr> <tr> <td>8</td> <td>to 6</td> </tr> </table> 	No. 2 on octal	to No. 1 on loctal	3	to 2	4	to 3	5	to 4	6	to 7 and 5	7	to 8	8	to 6
No. 2 on octal	to No. 1 on loctal																
3	to 2																
4	to 3																
5	to 4																
6	to 7 and 5																
7	to 8																
8	to 6																
12SC7	12SL7	G	Same as 6SC7 to 6SL7.														
	1634	G	No changes.														

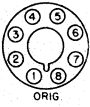

## RECEIVING TUBE SUBSTITUTION GUIDE

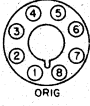
12SF5-12SK7

TUBE	SUB.	PERF.	CIRCUIT CHANGES NECESSARY
12SF5	12F5	G	Reverse 6F5 to 6SF5 procedure.
	12J5	G	Rewire as follows: Reverse No. 2 and No. 8 Reverse No. 3 and No. 5
12SF7	12SK7 and Germanium Diode	P	Rewire as follows: Move wire from No. 2 to No. 4 6 to 8 8 to 2 4 to 6 Remove wires from No. 5 Connect No. 3 and No. 5 together Diode crystal from No. 3 or 5 to wires removed from No. 3
	12SG7	G G G	Change socket to miniature and rewire as follows: No. 2 on octal to No. 3 on miniature 3 to 7 4 to 1 5 to 7 6 to 6 7 to 4 8 to 5
			 
	12SH7 12SJ7 12SK7	G G G	No changes.
12SH7	12AU6 12BA6 12BD6	G G G	Same as 12SG7 to 12BA6.
	12SG7 12SJ7 12SK7	G G G	No changes.
12SJ7	6S7 6W7	P P	Same as 12SK7 to 12K7. Series circuits only.
	12B7 14A7 14C7	G G G	Change socket to loctal and rewire as follows: No. 2 on octal to No. 1 on loctal 3 to 4 4 to 6 5 to 7 6 to 3 7 to 8 8 to 2
			 
	12J7 12K7	G G	Same as 12SK7 to 12K7.
12SK7	6S7 6W7	P P	Same as 12SK7 to 12K7. Series circuits only.
	6SS7	P	No changes. Series circuits only.

TUBE	SUB.	PERF.	CIRCUIT CHANGES NECESSARY
12SK7	12AV6	G	Change socket to miniature and rewire as follows: No. 2 on octal to No. 3 on miniature 3 to 2 4 to 1 5 to 7 6 to 6 7 to 4 8 to 5
	12BA6	G	
	12BD6	G	
			 
12B7	14A7	E	Change socket to loctal and rewire as follows: No. 1 on octal to No. 5 on loctal 2 to 1 3 to 4 4 to 6 5 to 7 6 to 3 7 to 8 8 to 2
	14A7	E	
	14C7	G	
			 
12J7	12K7	G	Make adaptor as follows: No. 1 on base to No. 1 on top 2 to 2 3 to 5 4 to cap 5 to 8 6 to 4 7 to 7 8 to 3
	12K7	E	
12SG7	12SH7	G	No changes.
	12SH7	G	
	12SJ7	G	
12SL7	12SC7	G	Reverse 6SC7 to 6SL7 procedure. If the 12SL7 employs the two cathodes separately this substitution may be impractical.
12SN7	12SL7	P	Parallel circuits only. No changes.
	12SX7	G	No changes.
12SQ7	6ST7	P	Series circuits. No changes.
	6T7	P	Same as 12SQ7 to 12Q7. Series circuits only.
	7C6	P	Same as 12SQ7 to 14B6. Series circuits only.
12AT6	12AV6	G	Change socket to miniature and rewire as follows: No. 2 on octal to No. 1 on miniature 3 to 2 4 to 5 5 to 6 6 to 7 7 to 3 8 to 4
	12AV6	G	
	12BK6	G	
	12BT6	G	
	12BU6	P	
			 

RECEIVING TUBE SUBSTITUTION GUIDE

12SQ7-14A4

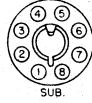
TUBE	SUB.	PERF.	CIRCUIT CHANGES NECESSARY																
12SQ7	12Q7	E	Make adaptor as follows: <table border="0" style="margin-left: 40px;"> <tr> <td style="text-align: center;">No. 1 on base</td> <td style="text-align: center;">to No. 1 on top</td> </tr> <tr> <td style="text-align: center;">2</td> <td style="text-align: center;">to cap</td> </tr> <tr> <td style="text-align: center;">3</td> <td style="text-align: center;">to 8</td> </tr> <tr> <td style="text-align: center;">4</td> <td style="text-align: center;">to 4</td> </tr> <tr> <td style="text-align: center;">5</td> <td style="text-align: center;">to 5</td> </tr> <tr> <td style="text-align: center;">6</td> <td style="text-align: center;">to 3</td> </tr> <tr> <td style="text-align: center;">7</td> <td style="text-align: center;">to 7</td> </tr> <tr> <td style="text-align: center;">8</td> <td style="text-align: center;">to 2</td> </tr> </table>	No. 1 on base	to No. 1 on top	2	to cap	3	to 8	4	to 4	5	to 5	6	to 3	7	to 7	8	to 2
No. 1 on base	to No. 1 on top																		
2	to cap																		
3	to 8																		
4	to 4																		
5	to 5																		
6	to 3																		
7	to 7																		
8	to 2																		
	12SR7	G	No changes.																
	12SW7	P	No changes.																
	14B6	E	Change socket to loctal and rewire as follows:																
	14E6	G	<table border="0" style="margin-left: 40px;"> <tr> <td style="text-align: center;">No. 2 on octal</td> <td style="text-align: center;">to No. 3 on loctal</td> </tr> <tr> <td style="text-align: center;">3</td> <td style="text-align: center;">to 7</td> </tr> <tr> <td style="text-align: center;">4</td> <td style="text-align: center;">to 5</td> </tr> <tr> <td style="text-align: center;">5</td> <td style="text-align: center;">to 6</td> </tr> <tr> <td style="text-align: center;">6</td> <td style="text-align: center;">to 2</td> </tr> <tr> <td style="text-align: center;">7</td> <td style="text-align: center;">to 8</td> </tr> <tr> <td style="text-align: center;">8</td> <td style="text-align: center;">to 1</td> </tr> </table>	No. 2 on octal	to No. 3 on loctal	3	to 7	4	to 5	5	to 6	6	to 2	7	to 8	8	to 1		
No. 2 on octal	to No. 3 on loctal																		
3	to 7																		
4	to 5																		
5	to 6																		
6	to 2																		
7	to 8																		
8	to 1																		
			 <small>ORIG.</small>																
			 <small>SUB.</small>																
12SR7	12AT6	P	Same as 12SQ7 to 12AT6.																
	12AV6	P																	
	12BK6	P																	
	12BT6	P																	
	12BU6	G																	
	12Q7	G	Same as 12SQ7 to 12Q7.																
	12SQ7	G	No changes.																
	12SW7	G	No changes.																
	14B6	G	Same as 12SQ7 to 14B6.																
	14E6	G																	
12SW7	12AT6	P	Same as 12SQ7 to 12AT6.																
	12AV6	P																	
	12BK6	P																	
	12BT6	P																	
	12BU6	G																	
	12SQ7	P	No changes.																
	12SR7	G																	
12SX7	12SL7	P	Parallel circuits only. No changes.																
	12SN7	G	No changes.																
12SY7	12SA7	G	No changes.																
	14Q7	G	Same as 12SA7 to 14Q7.																
12Z3	1V	G	Series Circuits only. No changes.																
	14Z3	G	No changes.																
12Z5			No practical substitute.																
14A4	12J5	E	Reverse 6J5 to 7A4 procedure.																

**14A5-14E7**

**RECEIVING TUBE SUBSTITUTION GUIDE**





TUBE	SUB.	PERF.	CIRCUIT CHANGES NECESSARY
14A5	12A6	E	Reverse 35L6 to 35A5 procedure.
	1284	P	No changes. Connect No. 4 to No. 7 for best results.
14A7/12B7	6S7	P	Reverse 12K7 to 7B7 procedure. Series circuits only.
	6W7	P	
	6SS7	P	Reverse 12SJ7 to 7B7 procedure. Series circuits only.
	7B7	P	Series circuits only. No changes.
	7C7	P	
	12B7	E	No changes.
	14C7	G	
	14H7	G	
	1280	G	
	1284	E	
	12J7	G	Reverse 12K7 to 7B7 procedure.
	12K7	E	
	12SH7	G	Reverse 12SJ7 to 7B7 procedure.
12SJ7	G		
12SK7	E		
14AF7/XXD	12AH7	G	Reverse 12AH7 to 14AF7/XXD procedure.
	14F7	G	No changes.
	14N7	G	Parallel circuits only. No changes.
14B6	7C6	P	Series circuits only. No changes.
	12Q7	E	Reverse 6Q7 to 7B6 procedure.
	14E6	G	No changes.
14B8	7A8	P	Series circuits only. No changes.
	12A8	G	Reverse 12A8 to 14B8 procedure.
	14J7	G	No changes.
	14S7	G	
14C5	14A5	G	Parallel circuits only. No changes.
14C7	7B7	P	Series circuits only. No changes.
	7C7	P	
	12B7	E	No changes.
	14A7	G	
	14H7	G	
	1280	G	
	1284	E	
	14E6	12Q7	
	14B6	G	No changes.
14E7	12C8	G	Reverse 12C8 to 14E7 procedure.

RECEIVING TUBE SUBSTITUTION GUIDE

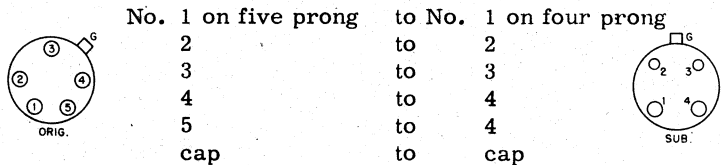
14E7-15

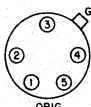
TUBE	SUB.	PERF.	CIRCUIT CHANGES NECESSARY
14E7	14R7	G	No changes.
14F7	12AH7	G	Reverse 12AH7 to 14AF7/XXD procedure.
	14AF7/XXD	G	No changes.
	14F8	G	Reverse 7F8 to 7F7 procedure.
14F8	14F7	G	Same as 7F8 to 7F7.
14H7	12B7	G	No changes.
	14A7	G	
	14C7	G	
	1280	G	
	1284	G	
14J7	7A8	P	Series circuits. No changes.
	14B8	G	No changes.
	14S7	G	
14N7	14AF7/XXD	G	Parallel circuits only. No changes.
14Q7	12SA7	G	Reverse 12SA7 to 14Q7 procedure.
14R7	12C8	G	Reverse 12C8 to 14E7 procedure.
	14E7	G	No changes.
14S7	7A8	P	Series circuits only. No changes. Put 200 or 250 ohm 1/2 watt resistor across filament terminals when substituting 7 volt for 12 volt types to compensate for faster heating.
	14B8	G	No changes.
	14J7	G	No changes.
14V7			No practical substitute.
14W7	12B7	G	No changes.
	14A7	G	
	14C7	G	
	14H7	G	
	1280	G	
	1284	G	
14Y4			No practical substitute.
15	1A4	G	Same as 15 to 1B4. Battery operation only. Parallel circuits.
	1B4	G	For battery operation only. Parallel circuits. Change socket to four prong type and rewire as follows:

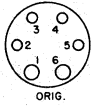
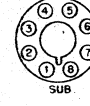
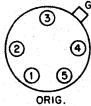
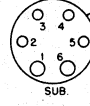

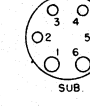
TUBE	SUB.	PERF.	CIRCUIT CHANGES NECESSARY												
15	1E5	G	For battery operation only. Parallel circuits. Change socket to octal and rewire as follows:  <table style="display: inline-table; vertical-align: middle;"> <tr> <td>No. 1 on five prong</td> <td>to No. 2 on octal</td> </tr> <tr> <td>2</td> <td>to 3</td> </tr> <tr> <td>3</td> <td>to 4</td> </tr> <tr> <td>4</td> <td>to 7</td> </tr> <tr> <td>5</td> <td>to 7</td> </tr> <tr> <td>cap</td> <td>to cap</td> </tr> </table> 	No. 1 on five prong	to No. 2 on octal	2	to 3	3	to 4	4	to 7	5	to 7	cap	to cap
No. 1 on five prong	to No. 2 on octal														
2	to 3														
3	to 4														
4	to 7														
5	to 7														
cap	to cap														
	32	G	Same as 15 to 1B4. Battery operation only. Parallel circuits.												
	34	G													
	951	G													
17			No practical substitute.												
18			No practical substitute.												
19	1J6	E	Change socket to octal and rewire as follows:  <table style="display: inline-table; vertical-align: middle;"> <tr> <td>No. 1 on six prong</td> <td>to No. 2 on octal</td> </tr> <tr> <td>2</td> <td>to 3</td> </tr> <tr> <td>3</td> <td>to 4</td> </tr> <tr> <td>4</td> <td>to 5</td> </tr> <tr> <td>5</td> <td>to 6</td> </tr> <tr> <td>6</td> <td>to 7</td> </tr> </table> 	No. 1 on six prong	to No. 2 on octal	2	to 3	3	to 4	4	to 5	5	to 6	6	to 7
No. 1 on six prong	to No. 2 on octal														
2	to 3														
3	to 4														
4	to 5														
5	to 6														
6	to 7														
19BG6	25BQ6	P	Rewire as follows: <table style="display: inline-table; vertical-align: middle;"> <tr> <td>No. 8</td> <td>to No. 4</td> </tr> <tr> <td>3</td> <td>to 8</td> </tr> </table>	No. 8	to No. 4	3	to 8								
No. 8	to No. 4														
3	to 8														
19C8	19T8	G	No changes.												
19T8	19C8	G	No changes.												
20	X99	G	Parallel circuits only. No changes.												
20J8			No practical substitute.												
21A7			No practical substitute.												
22			No practical substitute.												
24A	35/51	G	Use as IF or RF amplifier. Does not make good detector.												
	57	G	Change socket to six prong and rewire as follows:  <table style="display: inline-table; vertical-align: middle;"> <tr> <td>No. 1 on five prong</td> <td>to No. 1 on six prong</td> </tr> <tr> <td>2</td> <td>to 2</td> </tr> <tr> <td>3</td> <td>to 3</td> </tr> <tr> <td>4</td> <td>to 4 and 5</td> </tr> <tr> <td>5</td> <td>to 6</td> </tr> <tr> <td>cap</td> <td>to cap</td> </tr> </table> 	No. 1 on five prong	to No. 1 on six prong	2	to 2	3	to 3	4	to 4 and 5	5	to 6	cap	to cap
No. 1 on five prong	to No. 1 on six prong														
2	to 2														
3	to 3														
4	to 4 and 5														
5	to 6														
cap	to cap														
	58	E													
25A6	25B6	G	No changes.												
	25C6	G													
	25L6	G													
	43	G	Change socket to six prong and rewire as follows:  <table style="display: inline-table; vertical-align: middle;"> <tr> <td>No. 2 on octal</td> <td>to No. 1 on six prong</td> </tr> <tr> <td>3</td> <td>to 2</td> </tr> <tr> <td>4</td> <td>to 3</td> </tr> <tr> <td>5</td> <td>to 4</td> </tr> <tr> <td>7</td> <td>to 6</td> </tr> <tr> <td>8</td> <td>to 5</td> </tr> </table> 	No. 2 on octal	to No. 1 on six prong	3	to 2	4	to 3	5	to 4	7	to 6	8	to 5
No. 2 on octal	to No. 1 on six prong														
3	to 2														
4	to 3														
5	to 4														
7	to 6														
8	to 5														

## RECEIVING TUBE SUBSTITUTION GUIDE

**25A6-25C6**

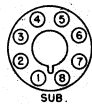
TUBE	SUB.	PERF.	CIRCUIT CHANGES NECESSARY												
25A6	5824	G	No changes.												
25A7	32L7	E	No changes.												
25AC5			This is a positive bias triode output tube. Operation can be accomplished by rewiring circuit and installing standard power amplifier tube.												
25AV5	25BQ6	G	Rewire as follows: <table style="margin-left: 40px; border: none;"> <tr> <td style="padding-right: 20px;">No. 8</td> <td style="padding-right: 20px;">to No. 4</td> </tr> <tr> <td>3</td> <td>to 8</td> </tr> <tr> <td>5</td> <td>to cap</td> </tr> <tr> <td>1</td> <td>to 5</td> </tr> </table>	No. 8	to No. 4	3	to 8	5	to cap	1	to 5				
No. 8	to No. 4														
3	to 8														
5	to cap														
1	to 5														
25B5	25N6	G	Change socket to octal and rewire as follows: <table style="margin-left: 40px; border: none;"> <tr> <td style="padding-right: 20px;">No. 1 on six prong</td> <td style="padding-right: 20px;">to No. 2 on octal</td> </tr> <tr> <td>2</td> <td>to 3</td> </tr> <tr> <td>3</td> <td>to 4</td> </tr> <tr> <td>4</td> <td>to 5</td> </tr> <tr> <td>5</td> <td>to 8</td> </tr> <tr> <td>6</td> <td>to 7</td> </tr> </table>	No. 1 on six prong	to No. 2 on octal	2	to 3	3	to 4	4	to 5	5	to 8	6	to 7
No. 1 on six prong	to No. 2 on octal														
2	to 3														
3	to 4														
4	to 5														
5	to 8														
6	to 7														
	25B6	G													
	25C6	G													
	25L6	G													
			<div style="display: flex; justify-content: space-around; align-items: center;">   </div>												
	43	G	No changes.												
25B6	25A6	G	No changes.												
	25B5	E	Reverse 25B5 to 25N6 procedure.												
	25G6	G	No changes.												
	25L6	G													
	25N6	G													
	43	G	Reverse 43 to 25L6 procedure.												
	5824	E	No changes.												
25B8GT			No practical substitute.												
25BQ6	19BG6	G	Rewire as follows: <table style="margin-left: 40px; border: none;"> <tr> <td style="padding-right: 20px;">No. 8</td> <td style="padding-right: 20px;">to No. 3</td> </tr> <tr> <td>4</td> <td>to 8</td> </tr> </table> Insert 20 ohm 10 watt resistor in series with filament circuit.	No. 8	to No. 3	4	to 8								
No. 8	to No. 3														
4	to 8														
	25AV5	G	Rewire as follows: <table style="margin-left: 40px; border: none;"> <tr> <td style="padding-right: 20px;">No. 5</td> <td style="padding-right: 20px;">to No. 1</td> </tr> <tr> <td>cap</td> <td>to 5</td> </tr> <tr> <td>8</td> <td>to 3</td> </tr> <tr> <td>4</td> <td>to 8</td> </tr> </table>	No. 5	to No. 1	cap	to 5	8	to 3	4	to 8				
No. 5	to No. 1														
cap	to 5														
8	to 3														
4	to 8														
25C6	25A6	G	No changes.												
	25B5	G	Reverse 25B5 to 25N6 procedure.												
	25B6	G	No changes.												
	25LG	G													
	25N6	G	No changes.												
	43	G	Reverse 43 to 25L6 procedure.												
	5824	G	No changes.												

**25D8GT-25Z5**

**RECEIVING TUBE SUBSTITUTION GUIDE**

TUBE	SUB.	PERF.	CIRCUIT CHANGES NECESSARY
25D8GT			No practical substitute.
25L6	25A6	G	No changes.
	25B5	G	Reverse 25B5 to 25N6 procedure.
	25B6	G	No changes.
	25C6	G	
	25N6	G	No changes.
	43	G	Reverse 43 to 25L6 procedure.
25L6	5824	E	No changes.
	25N6	G	Reverse 25B5 to 25N6 procedure.
25S	1B5	E	No changes.
25W4	25Z6	E	Rewire as follows: No. 8                      to No. 2 3                           to 4 Connect No. 4 and No. 8 together 3 and 5 together
25X6	25Z6	G	Where 25X6 is used by itself only. Replace line cord with 310 ohms. No changes.
	50X6	G	When 25X6 is used by itself, replace line cord or filament dropping resistor with 445 ohms. Change socket to loctal and rewire as follows: No. 2 on octal           to No. 1 on loctal 3                           to 3 4                           to 2 5                           to 6 7                           to 8 8                           to 7
	50Y6	G	Where 25X6 is used by itself, replace line cord or filament dropping resistor with 445 ohms.
	50Y7	G	When 25X6 is used by itself, replace line cord or filament dropping resistor with 445 ohms. Do not use No. 6 for anchor.
	50Z7	G	
25Y4			No practical substitute.
25Y5	25Z5	E	No changes.
	25Z6	E	Same as 25Z5 to 25Z6.
25Z3			No practical substitute.
25Z4	25Z6	E	No changes. Remove and tape up wires on unused terminals.
25Z5	6J5	P	Connect 60 ohm 5 watt resistor in series with filament circuit, will not work in voltage doubler circuit. If one cathode is used by itself for field excitation connect 4 and 8 together.
	25Y5	E	No changes.





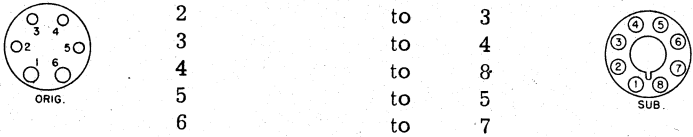
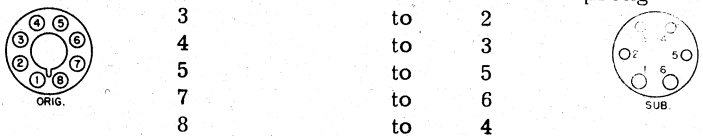

RECEIVING TUBE SUBSTITUTION GUIDE

25Z5-27

TUBE	SUB.	PERF.	CIRCUIT CHANGES NECESSARY												
25Z5	25Z6	E	<p>Change socket to octal and rewire as follows:</p> <table border="0"> <tr> <td>No. 1 on six prong</td> <td>to No. 2 on octal</td> </tr> <tr> <td>2</td> <td>to 3</td> </tr> <tr> <td>3</td> <td>to 4</td> </tr> <tr> <td>4</td> <td>to 8</td> </tr> <tr> <td>5</td> <td>to 5</td> </tr> <tr> <td>6</td> <td>to 7</td> </tr> </table> 	No. 1 on six prong	to No. 2 on octal	2	to 3	3	to 4	4	to 8	5	to 5	6	to 7
No. 1 on six prong	to No. 2 on octal														
2	to 3														
3	to 4														
4	to 8														
5	to 5														
6	to 7														
25Z6	6J5	P	<p>Connect 60 ohm 5 watt resistor in series with filament circuit, will not work in voltage doubler circuit. If one cathode is used by itself for field excitation connect 4 and 3 together. Make adaptor as follows:</p> <table border="0"> <tr> <td>No. 1 on base</td> <td>to No. 2 on top</td> </tr> <tr> <td>2 and 5</td> <td>to 3 and 5</td> </tr> <tr> <td>3 and 4</td> <td>to 8</td> </tr> <tr> <td>6</td> <td>to 7</td> </tr> </table> <p>Can be used only in half wave circuits. If the cathodes are separate supplies in a half wave circuit connect 4 and 8 together. Insert 10 watt 75 or 100 ohm resistor in series with the filament string.</p>	No. 1 on base	to No. 2 on top	2 and 5	to 3 and 5	3 and 4	to 8	6	to 7				
No. 1 on base	to No. 2 on top														
2 and 5	to 3 and 5														
3 and 4	to 8														
6	to 7														
	6SL7	P	Insert 75 or 100 ohm 10 watt resistor in series with the filament string.												
	6SN7	P													
	25AC5	P	No changes. Use only where 4 and 8 are connected together. Will not work in voltage doubler circuit. If one cathode is used by itself for field excitation tie 4 and 8 together.												
	25W4	G	<p>When 25Z6 is used as straight half wave rectifier. Rewire as follows:</p> <table border="0"> <tr> <td>No. 3</td> <td>to No. 5</td> </tr> <tr> <td>4 and 8</td> <td>to 3</td> </tr> <tr> <td>2</td> <td>to 8</td> </tr> </table>	No. 3	to No. 5	4 and 8	to 3	2	to 8						
No. 3	to No. 5														
4 and 8	to 3														
2	to 8														
	25Z4	G	<p>Where 25Z6 is used as straight half wave rectifier only. Rewire as follows:</p> <table border="0"> <tr> <td>No. 3</td> <td>to No. 5</td> </tr> <tr> <td>4</td> <td>to 8</td> </tr> </table>	No. 3	to No. 5	4	to 8								
No. 3	to No. 5														
4	to 8														
	25Z5	E	<p>Change octal to six prong socket and rewire as follows:</p> <table border="0"> <tr> <td>No. 2 on octal</td> <td>to No. 1 on six prong</td> </tr> <tr> <td>3</td> <td>to 2</td> </tr> <tr> <td>4</td> <td>to 3</td> </tr> <tr> <td>5</td> <td>to 5</td> </tr> <tr> <td>7</td> <td>to 6</td> </tr> <tr> <td>8</td> <td>to 4</td> </tr> </table> 	No. 2 on octal	to No. 1 on six prong	3	to 2	4	to 3	5	to 5	7	to 6	8	to 4
No. 2 on octal	to No. 1 on six prong														
3	to 2														
4	to 3														
5	to 5														
7	to 6														
8	to 4														
	35Z6	G	No changes.												
26			No practical substitute.												
26A6			No practical substitute.												
26A7			No practical substitute.												
26BK6	26C6	P	No changes.												
26C6	26BK6	P	No changes.												
26D6			No practical substitute.												
27	56	G	No changes.												
	485	P													



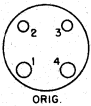





**28D7-35A5**

**RECEIVING TUBE SUBSTITUTION GUIDE**

TUBE	SUB.	PERF.	CIRCUIT CHANGES NECESSARY															
28D7	28D7W	E	No changes.															
28D7W	28D7	E	No changes.															
28Z5			No practical substitute.															
30	1E4	P	Change socket to octal and rewire as follows: <div style="display: flex; align-items: center; justify-content: center;"> <div style="text-align: center;">  <p>ORIG.</p> </div> <div style="margin: 0 10px;"> <p>No. 1 on four prong</p> <p>2</p> <p>3</p> <p>4</p> </div> <div style="text-align: center;"> <p>to No. 2 on octal</p> <p>to 3</p> <p>to 5</p> <p>to 7</p> </div> <div style="text-align: center;">  <p>SUB.</p> </div> </div>															
	1G4	P																
	1H4	E																
	31	G	Parallel circuits only. No changes.															
31	30	G	Parallel circuits only. No changes.															
32	1A4	G	No changes. 34 does not make good detector.															
	1B4	G																
	34	G																
	951	G																
32L7	25A7	E	No changes.															
	70A7	G	No changes. Difference in filament current makes necessary line resistance the same. Use only where 32L7 does not have other tubes in series with it.															
	70L7	G	Reverse 6 and 8. Cord is correct. Use only where 32L7 does not have other tubes in series with it.															
	117L7	G	Remove or short out the filament resistor and reverse connections 4 and 5 to socket.															
	117M7	G																
	117N7	G	Remove or short out filament resistor. Change connections as follows: <table style="margin-left: auto; margin-right: auto;"> <tr> <td>No. 6</td> <td>to</td> <td>7</td> </tr> <tr> <td>8</td> <td>to</td> <td>6</td> </tr> <tr> <td>1</td> <td>to</td> <td>8</td> </tr> <tr> <td>4</td> <td>to</td> <td>5</td> </tr> <tr> <td>5</td> <td>to</td> <td>4</td> </tr> </table>	No. 6	to	7	8	to	6	1	to	8	4	to	5	5	to	4
No. 6	to	7																
8	to	6																
1	to	8																
4	to	5																
5	to	4																
	117P7	G																
			Use only in conventional circuits where rectifier is first in the string and A.C. is connected to No. 7.															
33	1F4	G	Parallel circuits only. No changes.															
	950	E																
34	1A4	G	No changes.															
	1B4	G																
	32	G																
	951	G																
35A5	6G6	P	Same as 35A5 to 35L6 but put a 250 ohm 10 watt resistor in series with the filament circuit.															
	12A6	P	Same as above but put a 250 ohm 10 watt resistor in series with filament circuit.															
	14A5	P	Put 125 ohm 10 W resistor in series with filament.															

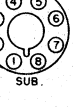

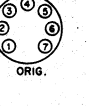
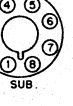
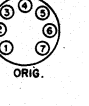



# RECEIVING TUBE SUBSTITUTION GUIDE

35A5-35C5

TUBE	SUB.	PERF.	CIRCUIT CHANGES NECESSARY														
35A5	35B5 50B5	E G	<p>Change socket to miniature and rewire as follows:</p> <table style="margin-left: 40px;"> <tr> <td style="width: 100px;">No. 1 on loctal</td> <td>to No. 3 on miniature</td> </tr> <tr> <td>2</td> <td>to 5</td> </tr> <tr> <td>3</td> <td>to 6</td> </tr> <tr> <td>6</td> <td>to 1</td> </tr> <tr> <td>7</td> <td>to 2</td> </tr> <tr> <td>8</td> <td>to 4</td> </tr> </table> <div style="display: flex; justify-content: space-around; align-items: center;">   </div> <p style="margin-left: 40px;">Do not use No. 7 on miniature.</p>	No. 1 on loctal	to No. 3 on miniature	2	to 5	3	to 6	6	to 1	7	to 2	8	to 4		
No. 1 on loctal	to No. 3 on miniature																
2	to 5																
3	to 6																
6	to 1																
7	to 2																
8	to 4																
	35C5 50C5	E G	<p>Change socket to miniature and rewire as follows:</p> <table style="margin-left: 40px;"> <tr> <td style="width: 100px;">No. 1 on loctal</td> <td>to No. 3 on miniature</td> </tr> <tr> <td>2</td> <td>to 7</td> </tr> <tr> <td>3</td> <td>to 6</td> </tr> <tr> <td>6</td> <td>to 2</td> </tr> <tr> <td>7</td> <td>to 1</td> </tr> <tr> <td>8</td> <td>to 4</td> </tr> </table> <div style="display: flex; justify-content: space-around; align-items: center;">   </div> <p style="margin-left: 40px;">Do not use No. 5 on miniature.</p>	No. 1 on loctal	to No. 3 on miniature	2	to 7	3	to 6	6	to 2	7	to 1	8	to 4		
No. 1 on loctal	to No. 3 on miniature																
2	to 7																
3	to 6																
6	to 2																
7	to 1																
8	to 4																
	35L6 50L6	E G	<p>Change socket to octal and rewire as follows:</p> <table style="margin-left: 40px;"> <tr> <td style="width: 100px;">No. 1 on loctal</td> <td>to No. 2 on octal</td> </tr> <tr> <td>2</td> <td>to 3</td> </tr> <tr> <td>3</td> <td>to 4</td> </tr> <tr> <td>6</td> <td>to 5</td> </tr> <tr> <td>7</td> <td>to 8</td> </tr> <tr> <td>8</td> <td>to 7</td> </tr> </table> <div style="display: flex; justify-content: space-around; align-items: center;">   </div>	No. 1 on loctal	to No. 2 on octal	2	to 3	3	to 4	6	to 5	7	to 8	8	to 7		
No. 1 on loctal	to No. 2 on octal																
2	to 3																
3	to 4																
6	to 5																
7	to 8																
8	to 7																
	50A5	G	No changes.														
35B5	35A5 50A5	E G	<p>Where space permits. Change socket to loctal and rewire as follows.</p> <table style="margin-left: 40px;"> <tr> <td style="width: 100px;">No. 1 on miniature</td> <td>to No. 6 on loctal</td> </tr> <tr> <td>2</td> <td>to 7</td> </tr> <tr> <td>3</td> <td>to 1</td> </tr> <tr> <td>4</td> <td>to 8</td> </tr> <tr> <td>5</td> <td>to 2</td> </tr> <tr> <td>6</td> <td>to 3</td> </tr> <tr> <td>7</td> <td>to 6</td> </tr> </table> <div style="display: flex; justify-content: space-around; align-items: center;">   </div>	No. 1 on miniature	to No. 6 on loctal	2	to 7	3	to 1	4	to 8	5	to 2	6	to 3	7	to 6
No. 1 on miniature	to No. 6 on loctal																
2	to 7																
3	to 1																
4	to 8																
5	to 2																
6	to 3																
7	to 6																
	35C5 50C5	E G	<p>Rewire as follows:</p> <p style="margin-left: 40px;">Reverse No. 1 and No. 2 5 and 7</p>														
	35L6 50L6	E G	<p>Where space permits. Change socket to octal and rewire as follows:</p> <table style="margin-left: 40px;"> <tr> <td style="width: 100px;">No. 1 on miniature</td> <td>to No. 5 on octal</td> </tr> <tr> <td>2</td> <td>to 8</td> </tr> <tr> <td>3</td> <td>to 2</td> </tr> <tr> <td>4</td> <td>to 7</td> </tr> <tr> <td>5</td> <td>to 3</td> </tr> <tr> <td>6</td> <td>to 4</td> </tr> <tr> <td>7</td> <td>to 5</td> </tr> </table> <div style="display: flex; justify-content: space-around; align-items: center;">   </div>	No. 1 on miniature	to No. 5 on octal	2	to 8	3	to 2	4	to 7	5	to 3	6	to 4	7	to 5
No. 1 on miniature	to No. 5 on octal																
2	to 8																
3	to 2																
4	to 7																
5	to 3																
6	to 4																
7	to 5																
	50B5	G	No changes.														
35C5	35A5 50A5	E G	<p>Where space permits, change socket to loctal and rewire as follows:</p> <table style="margin-left: 40px;"> <tr> <td style="width: 100px;">No. 1 on miniature</td> <td>to No. 7 on loctal</td> </tr> <tr> <td>2</td> <td>to 6</td> </tr> <tr> <td>3</td> <td>to 1</td> </tr> <tr> <td>4</td> <td>to 8</td> </tr> <tr> <td>5</td> <td>to 6</td> </tr> <tr> <td>6</td> <td>to 3</td> </tr> <tr> <td>7</td> <td>to 2</td> </tr> </table> <div style="display: flex; justify-content: space-around; align-items: center;">   </div>	No. 1 on miniature	to No. 7 on loctal	2	to 6	3	to 1	4	to 8	5	to 6	6	to 3	7	to 2
No. 1 on miniature	to No. 7 on loctal																
2	to 6																
3	to 1																
4	to 8																
5	to 6																
6	to 3																
7	to 2																

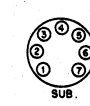
**35L6-35Y4**

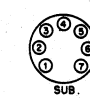
**RECEIVING TUBE SUBSTITUTION GUIDE**

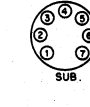
TUBE	SUB.	PERF.	CIRCUIT CHANGES NECESSARY												
35L6	6G6	P	Put 250 ohm 10 watt resistor in series with filament circuit.												
	12A6	P	Insert 150 ohms resistance in series with the filament circuit.												
	12J5	P	Insert 150 ohms resistance in series with the filament circuit.												
35A5 50A5	E G		<p>Change socket to loctal and rewire as follows:</p> <table border="0"> <tr> <td>No. 2 on octal</td> <td>to No. 1 on loctal</td> </tr> <tr> <td>5</td> <td>to 2</td> </tr> <tr> <td>4</td> <td>to 3</td> </tr> <tr> <td>5</td> <td>to 6</td> </tr> <tr> <td>8</td> <td>to 7</td> </tr> <tr> <td>7</td> <td>to 8</td> </tr> </table> <div style="display: flex; justify-content: space-around; align-items: center;">   </div>	No. 2 on octal	to No. 1 on loctal	5	to 2	4	to 3	5	to 6	8	to 7	7	to 8
No. 2 on octal	to No. 1 on loctal														
5	to 2														
4	to 3														
5	to 6														
8	to 7														
7	to 8														
35B5 50B5	E G		<p>Change socket to miniature and rewire as follows:</p> <table border="0"> <tr> <td>No. 2 on octal</td> <td>to No. 3 on miniature</td> </tr> <tr> <td>3</td> <td>to 5</td> </tr> <tr> <td>4</td> <td>to 6</td> </tr> <tr> <td>5</td> <td>to 1</td> </tr> <tr> <td>7</td> <td>to 4</td> </tr> <tr> <td>8</td> <td>to 2</td> </tr> </table> <p>Do not use No. 7 on miniature.</p> <div style="display: flex; justify-content: space-around; align-items: center;">   </div>	No. 2 on octal	to No. 3 on miniature	3	to 5	4	to 6	5	to 1	7	to 4	8	to 2
No. 2 on octal	to No. 3 on miniature														
3	to 5														
4	to 6														
5	to 1														
7	to 4														
8	to 2														
35C5 50C5	E G		<p>Change socket to miniature and rewire as follows:</p> <table border="0"> <tr> <td>No. 2 on octal</td> <td>to No. 3 on miniature</td> </tr> <tr> <td>3</td> <td>to 7</td> </tr> <tr> <td>4</td> <td>to 6</td> </tr> <tr> <td>5</td> <td>to 2</td> </tr> <tr> <td>7</td> <td>to 4</td> </tr> <tr> <td>8</td> <td>to 1</td> </tr> </table> <p>Do not use terminal No. 5 on miniature.</p> <div style="display: flex; justify-content: space-around; align-items: center;">   </div>	No. 2 on octal	to No. 3 on miniature	3	to 7	4	to 6	5	to 2	7	to 4	8	to 1
No. 2 on octal	to No. 3 on miniature														
3	to 7														
4	to 6														
5	to 2														
7	to 4														
8	to 1														
50C6 50L6	G G		No changes.												
35W4	35Y4	E	Where space permits. Reverse 35Y4 to 35W4 procedure.												
	35Z3 35Z5	E E													
117Z3	G		<p>Where 35W4 is used by itself only. Remove line cord resistor or filament dropping resistor and replace with ordinary line cord. Rewire as follows:          Remove and tape up any wires on No. 6          No. 7 to No. 6          Pilot light will not burn. In order to light pilot light, connect 40 ohm 1 watt resistor in series with filament and connect pilot light across it.</p>												
35Y4	35W4	E	<p>Change socket to miniature and rewire as follows:</p> <table border="0"> <tr> <td>No. 1 on loctal</td> <td>to No. 3 on miniature</td> </tr> <tr> <td>2</td> <td>to 5</td> </tr> <tr> <td>4</td> <td>to 6</td> </tr> <tr> <td>7</td> <td>to 7</td> </tr> <tr> <td>8</td> <td>to 4</td> </tr> </table> <div style="display: flex; justify-content: space-around; align-items: center;">   </div>	No. 1 on loctal	to No. 3 on miniature	2	to 5	4	to 6	7	to 7	8	to 4		
No. 1 on loctal	to No. 3 on miniature														
2	to 5														
4	to 6														
7	to 7														
8	to 4														
35Z3	E		No change is necessary but pilot light will not light. Pilot light can be lit by same method as used from 35Z5 to 35Z4.												

RECEIVING TUBE SUBSTITUTION GUIDE

35Y4-35Z5

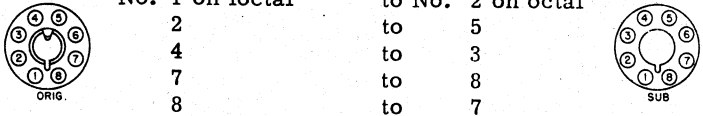
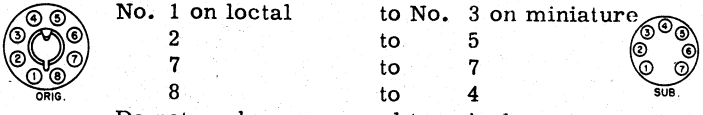
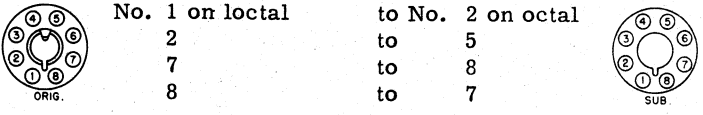
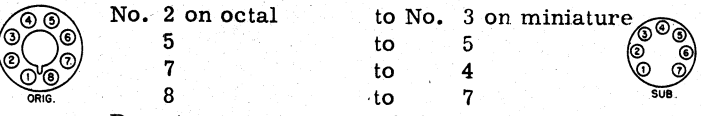
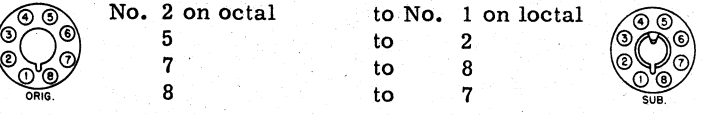
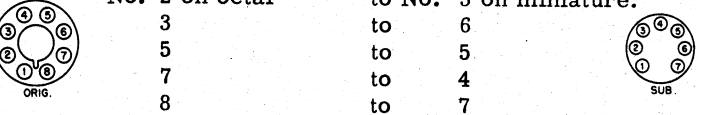
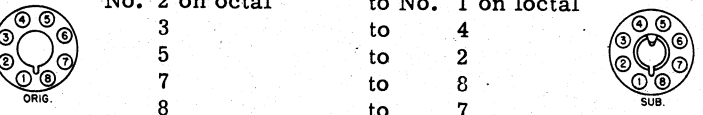
TUBE	SUB.	PERF.	CIRCUIT CHANGES NECESSARY										
35Y4	35Z5	E	<p>Change socket to octal and rewire as follows:</p> <table border="0"> <tr> <td>No. 1 on loctal</td> <td>to No. 2 on octal</td> </tr> <tr> <td>2</td> <td>to 5</td> </tr> <tr> <td>4</td> <td>to 3</td> </tr> <tr> <td>7</td> <td>to 8</td> </tr> <tr> <td>8</td> <td>to 7</td> </tr> </table> 	No. 1 on loctal	to No. 2 on octal	2	to 5	4	to 3	7	to 8	8	to 7
No. 1 on loctal	to No. 2 on octal												
2	to 5												
4	to 3												
7	to 8												
8	to 7												
35Z3	7A6	P	<p>Move wire from No. 2 to No. 3. Short 3 and 6 together and 2 and 7 together. Connect 200 ohm 10W resistor in series with filament circuit.</p>										
	35W4	E	<p>Change socket to miniature and rewire as follows:</p> <table border="0"> <tr> <td>No. 1 on loctal</td> <td>to No. 3 on miniature</td> </tr> <tr> <td>2</td> <td>to 5</td> </tr> <tr> <td>7</td> <td>to 7</td> </tr> <tr> <td>8</td> <td>to 4</td> </tr> </table> <p>Do not anchor on unused terminals.</p> 	No. 1 on loctal	to No. 3 on miniature	2	to 5	7	to 7	8	to 4		
No. 1 on loctal	to No. 3 on miniature												
2	to 5												
7	to 7												
8	to 4												
	35Y4	E	<p>No changes. Remove wires, if any, from pin No. 4 and tape them up.</p>										
	35Z4	E	<p>Change socket to octal and rewire as follows:</p> <table border="0"> <tr> <td>No. 1 on loctal</td> <td>to No. 2 on octal</td> </tr> <tr> <td>2</td> <td>to 5</td> </tr> <tr> <td>7</td> <td>to 8</td> </tr> <tr> <td>8</td> <td>to 7</td> </tr> </table> 	No. 1 on loctal	to No. 2 on octal	2	to 5	7	to 8	8	to 7		
No. 1 on loctal	to No. 2 on octal												
2	to 5												
7	to 8												
8	to 7												
	35Z5	E											
	45Z5	G	<p>Same as 35Z3 to 35Z4.</p>										
35Z4	12J5	P	<p>Add 150 ohm 5W resistor in series with filaments. Short Nos. 3 and 5.</p>										
	35W4	E	<p>Change socket to miniature and rewire as follows:</p> <table border="0"> <tr> <td>No. 2 on octal</td> <td>to No. 3 on miniature</td> </tr> <tr> <td>5</td> <td>to 5</td> </tr> <tr> <td>7</td> <td>to 4</td> </tr> <tr> <td>8</td> <td>to 7</td> </tr> </table> <p>Do not connect to unused terminals.</p> 	No. 2 on octal	to No. 3 on miniature	5	to 5	7	to 4	8	to 7		
No. 2 on octal	to No. 3 on miniature												
5	to 5												
7	to 4												
8	to 7												
	35Y4	E	<p>Change socket to loctal and rewire as follows:</p> <table border="0"> <tr> <td>No. 2 on octal</td> <td>to No. 1 on loctal</td> </tr> <tr> <td>5</td> <td>to 2</td> </tr> <tr> <td>7</td> <td>to 8</td> </tr> <tr> <td>8</td> <td>to 7</td> </tr> </table> 	No. 2 on octal	to No. 1 on loctal	5	to 2	7	to 8	8	to 7		
No. 2 on octal	to No. 1 on loctal												
5	to 2												
7	to 8												
8	to 7												
	35Z3	E											
	35Z5	E	<p>No change is necessary but remove wires, if any, from pin No. 3 and tape them up.</p>										
35Z5	12J5	P	<p>Add 150 ohm 5W resistor in series with filaments. Remove wires from No. 3 and connect to No. 2 through 25 or 30 ohm 1W resistor. Short Nos. 3 and 5.</p>										
	35W4	E	<p>Change socket to miniature and rewire as follows:</p> <table border="0"> <tr> <td>No. 2 on octal</td> <td>to No. 3 on miniature.</td> </tr> <tr> <td>3</td> <td>to 6</td> </tr> <tr> <td>5</td> <td>to 5</td> </tr> <tr> <td>7</td> <td>to 4</td> </tr> <tr> <td>8</td> <td>to 7</td> </tr> </table> <p>Do not connect to unused terminals.</p> 	No. 2 on octal	to No. 3 on miniature.	3	to 6	5	to 5	7	to 4	8	to 7
No. 2 on octal	to No. 3 on miniature.												
3	to 6												
5	to 5												
7	to 4												
8	to 7												
	35Y4	E	<p>Change socket to loctal and rewire as follows:</p> <table border="0"> <tr> <td>No. 2 on octal</td> <td>to No. 1 on loctal</td> </tr> <tr> <td>3</td> <td>to 4</td> </tr> <tr> <td>5</td> <td>to 2</td> </tr> <tr> <td>7</td> <td>to 8</td> </tr> <tr> <td>8</td> <td>to 7</td> </tr> </table> 	No. 2 on octal	to No. 1 on loctal	3	to 4	5	to 2	7	to 8	8	to 7
No. 2 on octal	to No. 1 on loctal												
3	to 4												
5	to 2												
7	to 8												
8	to 7												

**35Z5-40**

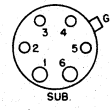
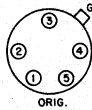

**RECEIVING TUBE SUBSTITUTION GUIDE**

TUBE	SUB.	PERF.	CIRCUIT CHANGES NECESSARY												
35Z5	35Z4	E	No change is necessary but pilot light will not light. In order to light the pilot light, put a 40 ohm resistor in series with the filaments and connect the pilot light across it. This resistor must have a 1 watt rating.												
	45Z5	G	No changes.												
35Z6	25Z6	G	No change, unless 35Z6 is used singly in which case put 35 ohm 10 watt resistor in filament string.												
	50Z6	G	No changes. Where a full set of five or six tubes are used, little change in operation will be noted. If 35Z6 is used by itself, this substitution may not be satisfactory.												
35/51	24A	G	No changes.												
36	6C6	E	Same as 37/44 to 6D6.												
	6D6	G													
	39/44	G	No changes.												
	77	E	Same as 39/44 to 6D6.												
	78	G													
37	76	E	No changes.												
38	41	G	Parallel circuits only. Reverse 41 to 38 procedure.												
	42	G													
39/44	6C6	G	Change socket to six prong and rewire as follows: <table border="0" style="margin-left: 40px;"> <tr> <td style="text-align: center;">No. 1 on five prong</td> <td style="text-align: center;">to No. 1 on six prong</td> </tr> <tr> <td style="text-align: center;">2</td> <td style="text-align: center;">to 2</td> </tr> <tr> <td style="text-align: center;">3</td> <td style="text-align: center;">to 3</td> </tr> <tr> <td style="text-align: center;">4</td> <td style="text-align: center;">to 4 and 5</td> </tr> <tr> <td style="text-align: center;">5</td> <td style="text-align: center;">to 6</td> </tr> <tr> <td style="text-align: center;">cap</td> <td style="text-align: center;">to cap</td> </tr> </table>	No. 1 on five prong	to No. 1 on six prong	2	to 2	3	to 3	4	to 4 and 5	5	to 6	cap	to cap
	No. 1 on five prong	to No. 1 on six prong													
	2	to 2													
	3	to 3													
	4	to 4 and 5													
5	to 6														
cap	to cap														
6D6	E														
77	G														
78	E														
	6J7	G	Reverse 6K7 to 39/44 procedure.												
	6K7	E													
	6S7	G	Reverse 6K7 to 39/44 procedure. Parallel circuits only.												
	6SH7	G	Reverse 6SK7 to 39/44 procedure.												
	6SJ7	G													
	6SK7	E													
	6SS7	G	Reverse 6SK7 to 39/44 procedure. Parallel circuits only.												
	6U7	G	Reverse 6K7 to 39/44 procedure.												
	6W7	G													
	7A7	E	Reverse 7A7 to 39/44 procedure.												
	7H7	G													
	7L7	G													
	7B7	G	Reverse 7A7 to 39/44 procedure. Parallel circuits only.												
	7C7	G													
	36	G	No changes.												
40	00A	G	No changes.												
	01A	G													
	12A	G													

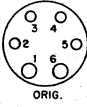

## RECEIVING TUBE SUBSTITUTION GUIDE

41-42

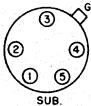
TUBE	SUB.	PERF.	CIRCUIT CHANGES NECESSARY												
41	6A4/LA	G	Parallel circuits only. Reverse 6A4/LA to 42 procedure.												
	6AD7	G	Reverse 6F6 to 41 procedure. Parallel circuits only. Connect nothing to unused pins.												
	6AR5	G	Change socket to miniature and rewire as follows: <div style="display: flex; justify-content: space-around; align-items: flex-start; margin-top: 10px;"> <table border="0" style="text-align: center;"> <tr> <td>No. 1 on six prong</td> <td>to No. 3 on miniature</td> </tr> <tr> <td>2</td> <td>to 5</td> </tr> <tr> <td>3</td> <td>to 6</td> </tr> <tr> <td>4</td> <td>to 1</td> </tr> <tr> <td>5</td> <td>to 2</td> </tr> <tr> <td>6</td> <td>to 4</td> </tr> </table> <div style="display: flex; align-items: center; gap: 20px;">   </div> </div>	No. 1 on six prong	to No. 3 on miniature	2	to 5	3	to 6	4	to 1	5	to 2	6	to 4
No. 1 on six prong	to No. 3 on miniature														
2	to 5														
3	to 6														
4	to 1														
5	to 2														
6	to 4														
	6F6	G	Parallel circuits only. Reverse 6F6 to 41 procedure.												
	6G6	P													
	6L6	G													
	6U6	G													
	6V6	G													
	6K6	E	Reverse 6F6 to 41 procedure.												
	7A5	G	Parallel circuits only. Reverse 7B5 to 41 procedure.												
	7B5	E	Reverse 7B5 to 41 procedure.												
	7C5	G	Parallel circuits only. Reverse 7B5 to 41 procedure.												
38		G	Parallel circuits only. Change socket to five prong and rewire as follows: <div style="display: flex; justify-content: space-around; align-items: flex-start; margin-top: 10px;"> <table border="0" style="text-align: center;"> <tr> <td>No. 1 on six prong</td> <td>to No. 1 on five prong</td> </tr> <tr> <td>2</td> <td>to 2</td> </tr> <tr> <td>3</td> <td>to 3</td> </tr> <tr> <td>4</td> <td>to cap</td> </tr> <tr> <td>5</td> <td>to 4</td> </tr> <tr> <td>6</td> <td>to 5</td> </tr> </table> <div style="display: flex; align-items: center; gap: 20px;">   </div> </div>	No. 1 on six prong	to No. 1 on five prong	2	to 2	3	to 3	4	to cap	5	to 4	6	to 5
No. 1 on six prong	to No. 1 on five prong														
2	to 2														
3	to 3														
4	to cap														
5	to 4														
6	to 5														
	42	G	No changes.												
	89	G	Change socket connections as follows: Move wire from No. 4 to cap. Short Nos. 4 and 5 together.												
42	6A4/LA	G	Parallel circuits only. Reverse 6A4/LA to 42 procedure.												
	6AD7	G	Parallel circuits only. Reverse 6F6 to 41 procedure. Remove and tape up any wires connected to unused pins.												
	6AR5	G	Same as 41 to 6AR5. Parallel circuits only.												
	6B5	G	No changes.												
	6F6	E	Reverse 6F6 to 41 procedure.												
	6G6	P	Parallel circuits only. Reverse 6F6 to 41 procedure.												
	6K6	G													
	6L6	G													
	6U6	G													
	6V6	G													
	7A5	G	Reverse 7B5 to 41 procedure.												
	7B5	G	Parallel circuits only. Reverse 7B5 to 41 procedure.												
	7C5	G													

RECEIVING TUBE SUBSTITUTION GUIDE

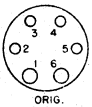
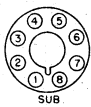
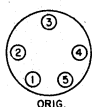
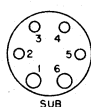
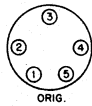
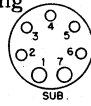
TUBE	SUB.	PERF.	CIRCUIT CHANGES NECESSARY												
42	38	G	Same as 41 to 38. Parallel circuits only.												
	41	G	No changes.												
	89	G	Same as 41 to 89. Parallel circuits only.												
43	25A6	G	Reverse 25A6 to 43 procedure.												
	25L6	E	Change socket to octal and rewire as follows: <table border="0" style="margin-left: 40px;"> <tr> <td>No. 1 on six prong</td> <td>to No. 2 on octal</td> </tr> <tr> <td>2</td> <td>to 3</td> </tr> <tr> <td>3</td> <td>to 4</td> </tr> <tr> <td>4</td> <td>to 5</td> </tr> <tr> <td>5</td> <td>to 8</td> </tr> <tr> <td>6</td> <td>to 7</td> </tr> </table> <div style="display: flex; justify-content: space-around; align-items: center; margin-top: 10px;">   </div>	No. 1 on six prong	to No. 2 on octal	2	to 3	3	to 4	4	to 5	5	to 8	6	to 7
No. 1 on six prong	to No. 2 on octal														
2	to 3														
3	to 4														
4	to 5														
5	to 8														
6	to 7														
45	2A3	G	No changes.												
45Z3	35W4	G	Where 45Z3 is used by itself only, remove 960-ohm line cord resistor or filament dropping resistor and replace with 550-ohm. Rewire as follows: <table border="0" style="margin-left: 40px;"> <tr> <td>No. 1</td> <td>to No. 3</td> </tr> <tr> <td>2</td> <td>to 5</td> </tr> <tr> <td>6</td> <td>to 5</td> </tr> </table> Reverse Nos. 4 and 7 Do not anchor to unused terminals.	No. 1	to No. 3	2	to 5	6	to 5						
No. 1	to No. 3														
2	to 5														
6	to 5														
	117Z3	G	Where 45Z3 is used by itself only, remove line cord resistor or filament dropping resistor and replace with ordinary line cord. Rewire as follows: <table border="0" style="margin-left: 40px;"> <tr> <td>No. 7</td> <td>to No. 3</td> </tr> <tr> <td>2 and 6</td> <td>to 5</td> </tr> <tr> <td>4</td> <td>to 6</td> </tr> <tr> <td>1</td> <td>to 4</td> </tr> </table>	No. 7	to No. 3	2 and 6	to 5	4	to 6	1	to 4				
No. 7	to No. 3														
2 and 6	to 5														
4	to 6														
1	to 4														
45Z5	35Z5	G	No changes.												
46	47	G	Only when 46 is operated as class A with plate and screen tied together.												
47	2A5	G	Change socket to six prong type and rewire as follows: <table border="0" style="margin-left: 40px;"> <tr> <td>No. 1 on five prong</td> <td>to No. 1 on six prong</td> </tr> <tr> <td>2</td> <td>to 2</td> </tr> <tr> <td>3</td> <td>to 4</td> </tr> <tr> <td>4</td> <td>to 3</td> </tr> <tr> <td>5</td> <td>to 6</td> </tr> </table> Connect 5 and 6 together. <div style="display: flex; justify-content: space-around; align-items: center; margin-top: 10px;">   </div>	No. 1 on five prong	to No. 1 on six prong	2	to 2	3	to 4	4	to 3	5	to 6		
No. 1 on five prong	to No. 1 on six prong														
2	to 2														
3	to 4														
4	to 3														
5	to 6														
46		P	Remove wire from No. 4 and short Nos. 2 and 4 together.												
59		G	Change socket to seven prong and rewire as follows: <table border="0" style="margin-left: 40px;"> <tr> <td>No. 1 on five prong</td> <td>to No. 1 on seven prong</td> </tr> <tr> <td>2</td> <td>to 2</td> </tr> <tr> <td>3</td> <td>to 4</td> </tr> <tr> <td>4</td> <td>to 3</td> </tr> <tr> <td>5</td> <td>to 5,6 and 7</td> </tr> </table> <div style="display: flex; justify-content: space-around; align-items: center; margin-top: 10px;">   </div>	No. 1 on five prong	to No. 1 on seven prong	2	to 2	3	to 4	4	to 3	5	to 5,6 and 7		
No. 1 on five prong	to No. 1 on seven prong														
2	to 2														
3	to 4														
4	to 3														
5	to 5,6 and 7														
1619		G	Parallel circuits only. Make adaptor as follows: <table border="0" style="margin-left: 40px;"> <tr> <td>No. 1 on base</td> <td>to No. 2 on top</td> </tr> <tr> <td>2</td> <td>to 3</td> </tr> <tr> <td>3</td> <td>to 5</td> </tr> <tr> <td>4</td> <td>to 4</td> </tr> <tr> <td>5</td> <td>to 7 and 8</td> </tr> </table> There are or will be many used 1619 tubes available.	No. 1 on base	to No. 2 on top	2	to 3	3	to 5	4	to 4	5	to 7 and 8		
No. 1 on base	to No. 2 on top														
2	to 3														
3	to 5														
4	to 4														
5	to 7 and 8														





## RECEIVING TUBE SUBSTITUTION GUIDE

48-50L6

TUBE	SUB.	PERF.	CIRCUIT CHANGES NECESSARY
48			No practical substitute.
49			No practical substitute.
50	10	G	No changes.
50A5	35A5	E	No changes. Place 100-ohm resistor in filament circuit.
	35B5	E	Same as 35A5 to 35B5. Place 100-ohm 10-W resistor in series with filaments.
	35C5	E	Same as 35A5 to 35C5. Place 100-ohm 10-W resistor in series with filament.
	35L6	E	Same as 35A5 to 35L6. Place 100-ohm resistor in filament circuit.
	50B5	E	Same as 35A5 to 35B5.
	50C5	E	Same as 35A5 to 35C5.
	50C6	G	Same as 35A5 to 35L6.
	50L6	E	
50AX6	50Z6	G	No changes.
50B5	35B5	E	Place 100 ohms 5 watts in series with filament.
	50A5	G	Where space permits. Same as 35B5 to 35A5.
	50C5	E	Same as 35B5 to 35C5.
	50L6	G	Where space permits. Same as 35B5 to 35L6.
50C5	50A5	G	Where space permits. Same as 35C5 to 35A5.
	50L6	E	Where space permits. Reverse 35L6 to 35C5 procedure.
50C6	35L6	G	Place 100-ohm 10-W resistor in series with filament.
	50A5	G	Same as 35L6 to 35A5.
	50L6	G	No changes.
50L6	12A6	P	No changes. Connect a 250-ohm 10-W resistor in series with the filament circuit.
	12J5	P	Emergency substitution. Works well at low volume. Put 250-ohm 10-w resistor in series with filaments.
	35A5	E	Same as 35L6 to 35A5. Place 100-ohm 5-w resistor in series with filaments.
	35B5	E	Same as 35L6 to 35B5. Place 100-ohm 10-w resistor in series with filament.
	35C5	E	Same as 35L6 to 35C5. Place 100-ohm 10-w resistor in series with filament.
	35L6	E	Place 100-ohm 5-w resistance in series with filaments.
	50B5	E	Same as 35L6 to 35B5.
	50C5	E	Same as 35L6 to 35C5.
	70A7	P	Remove and tape up wires connected to No. 6 or cut off No. 6 pin on 70A7.

**50X6-55S**

**RECEIVING TUBE SUBSTITUTION GUIDE**

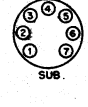
TUBE	SUB.	PERF.	CIRCUIT CHANGES NECESSARY														
50X6	25X6	G	Insert 160-ohm 10-w resistor in series with filament. Reverse 25X6 to 50X6 procedure.														
	50Y6	G	Reverse 25X6 to 50X6 procedure.														
	50Y7	E	Change socket to octal and rewire as follows:														
	50Z7	E															
			<table border="0"> <tr> <td>No. 1 on octal</td> <td>to No. 2 on octal</td> </tr> <tr> <td>2</td> <td>to 4</td> </tr> <tr> <td>3</td> <td>to 3</td> </tr> <tr> <td>6</td> <td>to 5</td> </tr> <tr> <td>7</td> <td>to 8</td> </tr> <tr> <td>8</td> <td>to 7</td> </tr> </table>	No. 1 on octal	to No. 2 on octal	2	to 4	3	to 3	6	to 5	7	to 8	8	to 7		
No. 1 on octal	to No. 2 on octal																
2	to 4																
3	to 3																
6	to 5																
7	to 8																
8	to 7																
			  <p>Do not use No. 6 for anchor.</p>														
50Y6	50Z7	E	No changes. Disconnect wires from pin No. 6, if any.														
50Y7	25X6	G	Insert 160-ohm 10-w resistor in series with filament. Reverse 25X6 to 50Y7 procedure.														
	50X6	G	Only when No. 7 filament tap on 50Y7 is not used. Reverse 50X6 to 50Y7 procedure.														
	50Y6	G	Only when No. 7 filament tap on 50Y7 is not used. Reverse 25X6 to 50Y7 procedure.														
	50Z7	G	No changes.														
50Z6	25Z6	E	No changes. Place 83-ohm 20-w resistor in series with filament.														
	35Z6	E	Place 50-ohm resistor in series with filament.														
	50AX6	E	No changes.														
50Z7	50Y6	E	No changes are necessary but pilot light will not light. You may light pilot light by inserting 40 ohms resistance in series with the filament circuit and connecting the pilot light across it.														
	50Y7	G	No changes.														
EF50	6AH6	G	Same as EF50 to 6AU6. Parallel circuits only.														
	6AK6	G															
	6AU6	G	Change socket to miniature and rewire as follows:														
	6BA6	G															
	6BD6	G	<table border="0"> <tr> <td>No. 1 on noval</td> <td>to No. 3 on miniature</td> </tr> <tr> <td>2</td> <td>to 6</td> </tr> <tr> <td>3</td> <td>to 5</td> </tr> <tr> <td>4</td> <td>to 2</td> </tr> <tr> <td>6</td> <td>to 7</td> </tr> <tr> <td>7</td> <td>to 1</td> </tr> <tr> <td>9</td> <td>to 4</td> </tr> </table>	No. 1 on noval	to No. 3 on miniature	2	to 6	3	to 5	4	to 2	6	to 7	7	to 1	9	to 4
No. 1 on noval	to No. 3 on miniature																
2	to 6																
3	to 5																
4	to 2																
6	to 7																
7	to 1																
9	to 4																
			 														
52			No practical substitution.														
VT52	10	P	Parallel circuits only. No changes.														
	50	P															
53	5608-A	E	No changes.														
55	2A6	E	No changes.														
55S	2A6	E	No changes.														
	55	E															

RECEIVING TUBE SUBSTITUTION GUIDE

56-70L7

TUBE	SUB.	PERF.	CIRCUIT CHANGES NECESSARY												
56	27	G	No changes.												
	485	G	No changes.												
56AS	37 76	E E	Parallel circuits only. No changes.												
56S	27 56	E E	No changes.												
57	58	G	No changes.												
57AS	6C6 77	E E	Parallel circuits only. No changes.												
57S	57 58	E E	No changes.												
58	57	G	No changes. 58 is not a good second detector.												
58AS	6D6 78	E E	Parallel circuits only. No changes.												
58S	57 58	E E	No changes.												
59	47	G	Reverse 47 to 59 procedure.												
	1619	G	Parallel circuits only. Make adaptor as follows: <table style="margin-left: 40px;"> <tr> <td>No. 1 on base</td> <td>to No. 2 on top</td> </tr> <tr> <td>2</td> <td>to 3</td> </tr> <tr> <td>3</td> <td>to 4</td> </tr> <tr> <td>4</td> <td>to 5</td> </tr> <tr> <td>5 and 6</td> <td>to 8</td> </tr> <tr> <td>7</td> <td>to 7</td> </tr> </table> <p style="margin-left: 40px;">There are or will be many used 1619 tubes available.</p>	No. 1 on base	to No. 2 on top	2	to 3	3	to 4	4	to 5	5 and 6	to 8	7	to 7
No. 1 on base	to No. 2 on top														
2	to 3														
3	to 4														
4	to 5														
5 and 6	to 8														
7	to 7														
70A7	32L7	G	No changes. Where no other tubes in series with the 70A7 which has 150 mil filament instead of 0.3 amp.												
	70L7	E	Change connection as follows: <table style="margin-left: 40px;"> <tr> <td>No. 8</td> <td>to No. 6</td> </tr> <tr> <td>6</td> <td>to 8</td> </tr> </table> <p style="margin-left: 40px;">Connect Nos. 7 and 8 together. Pilot light will not light but may be lit by same procedure as 50Z7 to 50Y6.</p>	No. 8	to No. 6	6	to 8								
No. 8	to No. 6														
6	to 8														
	117L7 117M7	E E	Remove the line cord resistor and replace with straight AC cord. Reverse connections to 4 and 5.												
	117N7 117P7	E E	Remove line resistor cord and replace with straight AC cord. <p style="margin-left: 40px;">Remove wire from No. 8 Move No. 1 to No. 8 Reverse Nos. 4 and 5 Move No. 6 to No. 7 Place No. 8 on No. 6</p>												
70L7	32L7	G	Cord is correct. If 32L7 is alone in circuit. Reverse Nos. 6 and 8.												
	70A7	E	Change connections as follows: <table style="margin-left: 40px;"> <tr> <td>No. 6</td> <td>to No. 8</td> </tr> <tr> <td>8</td> <td>to 6</td> </tr> </table>	No. 6	to No. 8	8	to 6								
No. 6	to No. 8														
8	to 6														

70L7-76

RECEIVING TUBE SUBSTITUTION GUIDE

TUBE	SUB.	PERF.	CIRCUIT CHANGES NECESSARY
70L7	117L7	E	Remove line resistor cord and replace with straight AC cord. Reverse Nos. 4 and 5 Reverse 6 and 8
	117M7	E	
	117N7	E	Remove line cord resistor and replace with straight AC cord. Reverse Nos 4 and 5 No. 8 on No. 7 1 on 8
	117P7	E	
71A	482	G	No changes. If push-pull circuit, both tubes must be changed to avoid hum.
	483	G	
75	6AQ6	G	Same as 75 to 6AT6. Parallel circuits only.
	6AT6	G	Change socket to miniature and rewire as follows: No. 1 on six prong to No. 3 on miniature 2 to 7 3 to 5 4 to 6 5 to 2 6 to 4 cap to 1
	6AV6	G	
	6BF6	G	
	6BK6	G	
	6BT6	G	
	6BU6	G	
6B6	6B6	E	Change socket to octal and rewire as follows: No. 1 on six prong to No. 2 on octal 2 to 3 3 to 4 4 to 5 5 to 8 6 to 7 cap to cap
	6Q7	E	
	6R7	G	
6C6	P	E	Emergency substitution. No changes but considerable loss of volume.
6SQ7	6SQ7	E	Reverse 6SQ7 to 75 procedure.
	6SR7	G	
6T7	G	G	Same as 75 to 6Q7. Parallel circuits only.
6V7	G	G	Same as 75 to 6Q7.
7B6	7B6	E	Change socket to loctal and rewire as follows: No. 1 on six prong to No. 1 on loctal 2 to 2 3 to 5 4 to 6 5 to 4 or 7 6 to 8 cap to 3
	7E6	G	
7C6	G	G	Same as above. Parallel circuits only.
85	G	G	No changes. Sometimes works excellent, other times not so well.
76	6AE5	G	Reverse 6C5 to 37 procedure.
	6C5	E	Reverse 6C5 to 37 procedure.
	6J5	G	Reverse 6C5 to 37 procedure.

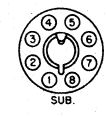
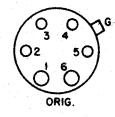
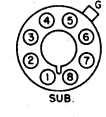
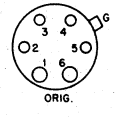
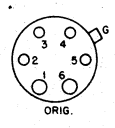

## RECEIVING TUBE SUBSTITUTION GUIDE











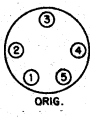

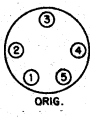

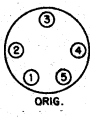

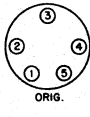

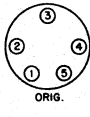
76-78

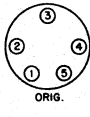
TUBE	SUB.	PERF.	CIRCUIT CHANGES NECESSARY
76	6L5	G	Reverse 6C5 to 37 procedure.
	6P5	G	Reverse 6C5 to 37 procedure.
	7A4	E	Reverse 7A4 to 37 procedure.
	7B4	G	
	XXL	E	
	37	E	No changes.
77	6C6	E	No changes.
	6D7	G	Same as 6C6 to 6D7.
	6E7	G	
	6J7	E	
	6K7	G	Same as 6C6 to 6J7.
	6S7	G	Same as 6C6 to 6J7. Parallel circuits only.
	6SH7	G	Same as 6C6 to 6SJ7.
	6SJ7	E	Same as 6C6 to 6SJ7.
	6SK7	G	Same as 6C6 to 6SJ7.
	6U7	G	Same as 6C6 to 6J7.
	6W7	G	Same as 6C6 to 6J7. Parallel circuits only.
	7A7	G	Same as 6C6 to 7A7.
	7B7	G	Same as 6C6 to 7A7. Parallel circuits only.
	7C7	G	
	7H7	G	Same as 6C6 to 7A7.
	7L7	G	Same as 6C6 to 7A7.
	1221	E	No changes.
78	6D6	E	No changes.
	6D7	G	Same as 6C6 to 6D7.
	6E7	G	
	6J5	G	Same as 6C6 to 6J7.
	6K7	E	
	6S7	G	Same as 6C6 to 6J7. Parallel circuits only.
	6SH7	G	Same as 6C6 to 6SJ7.
	6SJ7	G	Same as 6C6 to 6SJ7.
	6SK7	E	Same as 6C6 to 6SJ7.
	6U7	G	Same as 6C6 to 6J7.
	6W7	G	Same as 6C6 to 6J7. Parallel circuits only.
	7A7	E	Same as 6C6 to 7A7.

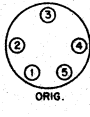
## RECEIVING TUBE SUBSTITUTION GUIDE

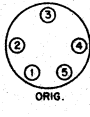
TUBE	SUB.	PERF.	CIRCUIT CHANGES NECESSARY
78	7B7	G	Same as 6C6 to 7A7. Parallel circuits only.
	7C7	G	Same as 6C6 to 7A7. Parallel circuits only.
	7H7	G	Same as 6C6 to 7A7.
	7L7	G	Same as 6C6 to 7A7.
	39/44	E	Change socket to five prong type and rewire as follows: No. 1 on six prong to No. 1 on five prong 2 to 2 3 to 3 4, remove and tape up 5 to 4 6 to 5 cap cap
79*	6A6	G	Parallel circuits only. Change socket to seven prong and rewire as follows: No. 1 on six prong to No. 1 on seven prong 2 to 2 3 to 3 4 to 4 5 to 6 6 to 7 cap to 5
	6N7	G	Parallel circuits only. Reverse 6N7 to 79 procedure.
	6Y7G	G	Reverse 6N7 to 79 procedure.
	6Z7	G	Parallel circuits only. Reverse 6N7 to 79 procedure.
	80	5T4	G
5U4		G	
5V4		G	
5W4		G	
5Y3		E	
5Z4		G	
5X4		G	Reverse 5X4 to 5Z3 procedure.
5Y4	E		
83V	83V	G	No changes.
	83	G	
	5Z3	G	No changes.
81	10	P	No changes.
	50	P	
82	2A3	P	No changes.
	45	P	
83	5T4	G	Same as 80 to 5U4.
	5U4	G	
	5X4	G	Reverse 5X4 to 5Z3 procedure.
	5Z3	G	No changes.

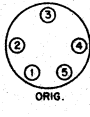
\* See Addendum at back of this section.

TUBE	SUB.	PERF.	CIRCUIT CHANGES NECESSARY													
83V	5T4	G	Same as 80 to 5U4.													
	5U4	G														
	5V4	G														
	5W4	G														
	5Y3	G														
	5Z3	G	No changes.													
	5Z4	G	Same as 80 to 5U4.													
	80	G	No changes.													
	83	G														
84	7Y4	E	<p>Change socket to octal and rewire as follows:</p> <table border="0"> <tr> <td style="text-align: center;">  <p>ORIG.</p> </td> <td style="vertical-align: middle;"> <table border="0"> <tr> <td>No. 1 on five prong</td> <td>to No. 1 on octal</td> </tr> <tr> <td>2</td> <td>to 3</td> </tr> <tr> <td>3</td> <td>to 6</td> </tr> <tr> <td>4</td> <td>to 7</td> </tr> <tr> <td>5</td> <td>to 8</td> </tr> </table> </td> <td style="text-align: center;">  <p>SUB.</p> </td> </tr> </table>	 <p>ORIG.</p>	<table border="0"> <tr> <td>No. 1 on five prong</td> <td>to No. 1 on octal</td> </tr> <tr> <td>2</td> <td>to 3</td> </tr> <tr> <td>3</td> <td>to 6</td> </tr> <tr> <td>4</td> <td>to 7</td> </tr> <tr> <td>5</td> <td>to 8</td> </tr> </table>	No. 1 on five prong	to No. 1 on octal	2	to 3	3	to 6	4	to 7	5	to 8	 <p>SUB.</p>
 <p>ORIG.</p>	<table border="0"> <tr> <td>No. 1 on five prong</td> <td>to No. 1 on octal</td> </tr> <tr> <td>2</td> <td>to 3</td> </tr> <tr> <td>3</td> <td>to 6</td> </tr> <tr> <td>4</td> <td>to 7</td> </tr> <tr> <td>5</td> <td>to 8</td> </tr> </table>	No. 1 on five prong	to No. 1 on octal	2	to 3	3	to 6	4	to 7	5	to 8	 <p>SUB.</p>				
No. 1 on five prong	to No. 1 on octal															
2	to 3															
3	to 6															
4	to 7															
5	to 8															
84/6Z4	6X4	G	<p>Parallel circuits only. Change socket to miniature and rewire as follows:</p> <table border="0"> <tr> <td style="text-align: center;">  <p>ORIG.</p> </td> <td style="vertical-align: middle;"> <table border="0"> <tr> <td>No. 1 on five prong</td> <td>to No. 3 on miniature</td> </tr> <tr> <td>2</td> <td>to 1</td> </tr> <tr> <td>3</td> <td>to 6</td> </tr> <tr> <td>4</td> <td>to 7</td> </tr> <tr> <td>5</td> <td>to 4</td> </tr> </table> </td> <td style="text-align: center;">  <p>SUB.</p> </td> </tr> </table>	 <p>ORIG.</p>	<table border="0"> <tr> <td>No. 1 on five prong</td> <td>to No. 3 on miniature</td> </tr> <tr> <td>2</td> <td>to 1</td> </tr> <tr> <td>3</td> <td>to 6</td> </tr> <tr> <td>4</td> <td>to 7</td> </tr> <tr> <td>5</td> <td>to 4</td> </tr> </table>	No. 1 on five prong	to No. 3 on miniature	2	to 1	3	to 6	4	to 7	5	to 4	 <p>SUB.</p>
			 <p>ORIG.</p>	<table border="0"> <tr> <td>No. 1 on five prong</td> <td>to No. 3 on miniature</td> </tr> <tr> <td>2</td> <td>to 1</td> </tr> <tr> <td>3</td> <td>to 6</td> </tr> <tr> <td>4</td> <td>to 7</td> </tr> <tr> <td>5</td> <td>to 4</td> </tr> </table>	No. 1 on five prong	to No. 3 on miniature	2	to 1	3	to 6	4	to 7	5	to 4	 <p>SUB.</p>	
No. 1 on five prong	to No. 3 on miniature															
2	to 1															
3	to 6															
4	to 7															
5	to 4															
6X5	E	<p>Change socket to octal and rewire as follows:</p> <table border="0"> <tr> <td style="text-align: center;">  <p>ORIG.</p> </td> <td style="vertical-align: middle;"> <table border="0"> <tr> <td>No. 1 on five prong</td> <td>to No. 2 on octal</td> </tr> <tr> <td>2</td> <td>to 3</td> </tr> <tr> <td>3</td> <td>to 5</td> </tr> <tr> <td>4</td> <td>to 8</td> </tr> <tr> <td>5</td> <td>to 7</td> </tr> </table> </td> <td style="text-align: center;">  <p>SUB.</p> </td> </tr> </table>	 <p>ORIG.</p>	<table border="0"> <tr> <td>No. 1 on five prong</td> <td>to No. 2 on octal</td> </tr> <tr> <td>2</td> <td>to 3</td> </tr> <tr> <td>3</td> <td>to 5</td> </tr> <tr> <td>4</td> <td>to 8</td> </tr> <tr> <td>5</td> <td>to 7</td> </tr> </table>	No. 1 on five prong	to No. 2 on octal	2	to 3	3	to 5	4	to 8	5	to 7	 <p>SUB.</p>	
 <p>ORIG.</p>	<table border="0"> <tr> <td>No. 1 on five prong</td> <td>to No. 2 on octal</td> </tr> <tr> <td>2</td> <td>to 3</td> </tr> <tr> <td>3</td> <td>to 5</td> </tr> <tr> <td>4</td> <td>to 8</td> </tr> <tr> <td>5</td> <td>to 7</td> </tr> </table>	No. 1 on five prong	to No. 2 on octal	2	to 3	3	to 5	4	to 8	5	to 7	 <p>SUB.</p>				
No. 1 on five prong	to No. 2 on octal															
2	to 3															
3	to 5															
4	to 8															
5	to 7															
85	6AQ6	G	Same as 75 to 6AT6. Parallel circuits only.													
	6AT6	G	Same as 75 to 6AT6.													
	6AV6	G														
	6B6	G	Same as 75 to 6Q7.													
	6BF6	G	Same as 75 to 6AT6.													
	6BK6	G														
	6BT6	G														
	6BU6	G														
	6Q7	G	Same as 75 to 6Q7.													
	6R7	E														
	6SQ7	G	Reverse 6SQ7 to 75 procedure.													
	6SR7	E														
	6T7	G	Same as 75 to 6Q7. Parallel circuits only.													
	6V7	G	Same as 75 to 6Q7.													
	7B6	G	Same as 75 to 7E6.													
7C6	G	Same as 75 to 7E6. Parallel circuits only.														
7E6	G	Same as 75 to 7E6.														

TUBE	SUB.	PERF.	CIRCUIT CHANGES NECESSARY														
85	75	G	No changes.														
85AS	85	E	No changes.														
89	6K6	G	Same as 6F6 to 89. Parallel or series circuits.														
	41	G	Reverse 41 to 89 procedure.														
	42	G	Parallel circuits only. Reverse 41 to 89 procedure.														
99V			No practical substitution.														
X99	20	G	Parallel circuits only. No changes.														
117L7	32L7	G	Place 280-ohm cord or 50-w resistor in series with filaments. Reverse socket connections Nos. 4 and 5.														
	70A7	G	Place 300-ohm cord or 10-w resistor in series with filaments. Reverse socket connections Nos. 4 and 5.														
	70L7	G	Place 300-ohm 10-w resistor in series with filaments. Reverse socket connections Nos. 4 and 5, also 6 and 8.														
	117M7	E	No changes.														
117L7 or 117M7	117N7 or 117P7	E	Make adaptor as follows:														
			<table border="0"> <tr> <td>No. 1 on base</td> <td>to No. 8 on top</td> </tr> <tr> <td>2</td> <td>to 2</td> </tr> <tr> <td>3</td> <td>to 3</td> </tr> <tr> <td>4</td> <td>to 4</td> </tr> <tr> <td>5</td> <td>to 5</td> </tr> <tr> <td>7</td> <td>to 7</td> </tr> <tr> <td>8</td> <td>to 6</td> </tr> </table>	No. 1 on base	to No. 8 on top	2	to 2	3	to 3	4	to 4	5	to 5	7	to 7	8	to 6
No. 1 on base	to No. 8 on top																
2	to 2																
3	to 3																
4	to 4																
5	to 5																
7	to 7																
8	to 6																
			AC line must connect to No. 7														
117L7/M7	25A7	G	Connect 300-ohm line cord in place of AC cord and change connections as follows: Reverse Nos. 4 and 5.														
117M7	32L7	G	Same as 117L7 to 32L7.														
	70A7	G	Same as 117L7 to 70A7.														
	70L7	G	Same as 117L7 to 70L7.														
117N7	25A7	G	Connect 300-ohm line cord in place of AC cord and change connections as follows:														
			<table border="0"> <tr> <td>No. 6</td> <td>to No. 7</td> </tr> <tr> <td>8</td> <td>to 6</td> </tr> <tr> <td>1</td> <td>to 8</td> </tr> </table>	No. 6	to No. 7	8	to 6	1	to 8								
No. 6	to No. 7																
8	to 6																
1	to 8																
			Reverse Nos. 4 and 5.														
	32L7	G	Remove and tape up any wire anchored on No. 1. Place 280-ohm cord or 50-w resistor in series with filaments. Reverse socket connections Nos. 4 and 5. Move No. 8 to No. 1.														
	70A7	G	Place 300-ohm cord or 10-w resistor in series with filaments. Reverse socket connections Nos. 4 and 5. Move No. 8 to No. 1 and No. 6 to No. 8.														
	70L7	G	Remove and tape up any wires connected to No. 1. Place 300-ohm cord or 10-w resistor in series with filaments. Reverse Nos. 4 and 5, move No. 8 to No. 1 and short Nos. 7 and 8 together. For use in circuits where AC line is connected to No. 7.														



RECEIVING TUBE SUBSTITUTION GUIDE

117N7-954

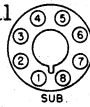
TUBE	SUB.	PERF.	CIRCUIT CHANGES NECESSARY
117N7	117P7	E	No changes.
117P7	25A7	G	Same as 117N7 to 25A7. Cord or resistor must dissipate 90 w.
117Z3	35W4	G	Replace line cord with 533-ohm resistor cord. Rewire as follows: No. 6 to No. 7 Do not use No. 6 for anchor.
	45Z3	G	Replace line cord with 960-ohm resistor cord. Rewire as follows. No. 3 to No. 1 4 to 7 5 to 2 6 to 4 Do not use unused terminals for anchors.
	117Z4	G	Where space permits. Change socket to octal and rewire as follows: No. 3 on miniature to No. 2 on octal 4 to 7 5 to 5 6 to 8
			 
117Z4	117Z3	G	Reverse 117Z3 to 117Z4 procedure.
	117Z6	E	No change except to remove and tape up any wires which may be anchored to Nos. 3 and 4.
117Z6	6X5	P	Connect 200-ohm 100-w resistor in series with filament. Use only where Nos. 4 and 8 are tied together.
	25Z6	G	Connect 300-ohm line cord or 50-w resistor in series with filament.
	50Y6	E	No change except that a 450-ohm 20-w resistor or line cord must be used in series with the filament.
	50Z6	E	Connect 220-ohm line cord in place of AC cord.
	50Z7	E	Connect 440-ohm line cord in place of AC cord.
182B/482B	71A	E	No changes.
	183/483	E	No changes.
183/483	71A	E	No changes.
	182B/482B	E	No changes.
210T	VT52	P	No changes.
	10	E	No changes.
	50	G	No changes.
485	27	G	No changes in connections but put one inch piece of screen wire doubled in series with one side of filament winding.
	56	G	Same as 485 to 27.
864			No practical substitute.
950	1F4	G	No changes.
	33	G	Parallel circuits only. No changes.
954	956	E	No changes.

TUBE	SUB.	PERF.	CIRCUIT CHANGES NECESSARY
955	5731	P	No changes.
956	954	E	No changes.
957	958A	G	Parallel circuits only. No changes.
958A	957	G	Parallel circuits only. No changes.
959			No practical substitute.
FM1000			No practical substitute.
1005/CK1005	0Y4 0Z4A	G G	No changes.
CK1013	5517	E	No changes.
1201	7E5	E	No changes.
1203	7C4	E	No changes.
1204	7AB7	E	No changes.
1206	7G8	E	No changes.
1221	6C6 77	E E	No changes.
1223	6J7	E	No changes.
1229	1A4 1B4 32 951	E E E E	No changes.
1230	30	E	No changes.
1231	7G7 7V7	G G	No changes.
1232	7G7	E	No changes.
1247			No practical substitute.
1265			No practical substitute.
1266			No practical substitute.
1267	0A4	G	No changes.
1273	7A7 7AJ7 7H7 7L7 7T7	G G G G G	No changes.
1274	6AX5 6W5 6ZY5	G G G	Parallel circuits only. No changes.
	6AX6	G	No change necessary but tie Nos. 4 and 8 together if convenient.

RECEIVING TUBE SUBSTITUTION GUIDE

1274-5517

TUBE	SUB.	PERF.	CIRCUIT CHANGES NECESSARY
1274	6BY5	G	Parallel circuits only. Rewire as follows: Connect Nos. 1 and 8 together No. 3 to No. 4
	6X5	E	No changes.
	7Y4	E	Same as 6X5 to 7Y4. Parallel circuits only.
	7Z4	E	
1275	5X3	G	No changes.
	5Z3	E	
	80	G	
	83	G	
	83V	G	
1276			No practical substitute.
1280	12B7	G	No changes.
	14A7	G	No changes.
	14C7	G	
	14H7	E	
	1284	G	
1284	12B7	G	No changes.
	14A7	G	
	14C7	G	
	14H7	G	
	1280	G	
1291	3B7	E	No changes.
1293	1LE3	G	Parallel circuits only. No changes.
1294	1R4	E	No changes.
1299	3D6	E	No changes.
1612	6L7	E	No changes.
1614	6L6	E	No changes.
1619	2A5	G	Reverse 2A5 to 1619 procedure.
1620	6J7	E	No changes.
1626	12E5	G	Parallel circuits only. No changes.
	12J5	G	
1629			No practical substitute.
1634	12SC7	G	No changes.
1644	12L8	G	No changes.
1654			No practical substitute.
2050	2051	E	No changes.
2051	2050	E	No changes.
5517	CK1013	E	No changes.

TUBE	SUB.	PERF.	CIRCUIT CHANGES NECESSARY												
5517/CK1013			No practical substitute.												
5590	6AG5 6BC5	P G	Parallel circuits only. No changes.												
	5591 9001 9003	G G G	No changes.												
5591	6BC5 6AG5	P G	Parallel circuits only. No changes.												
	5590 9001 9003	G G G	No changes.												
5608-A	53	E	No changes.												
5618	2E30 5812	G G	Parallel circuits only. Rewire as follows: Remove wires from No. 4 <table style="margin-left: 40px;"> <tr> <td>No. 1</td> <td>to No. 4</td> </tr> <tr> <td>6</td> <td>to 1</td> </tr> <tr> <td>3</td> <td>to 6</td> </tr> <tr> <td>7</td> <td>to 3</td> </tr> <tr> <td>5</td> <td>to 7</td> </tr> <tr> <td>2</td> <td>to 5</td> </tr> </table> Connect wires removed from No. 4 to No. 2.	No. 1	to No. 4	6	to 1	3	to 6	7	to 3	5	to 7	2	to 5
No. 1	to No. 4														
6	to 1														
3	to 6														
7	to 3														
5	to 7														
2	to 5														
5635			No practical substitute.												
5636			No practical substitute.												
5643			No practical substitute.												
5646			No practical substitute.												
5647			No practical substitute.												
5654	6AJ5 6AK5	G G	No changes.												
5670	7F8	G	Where space permits. Same as 2C51 to 7F8. Parallel circuits only.												
5672	5678	G	No changes.												
5676	5677	P	Parallel circuits only. No changes.												
5677	5676	G	Parallel circuits only. No changes.												
5678	5672	G	No changes.												
5679	7A6	E	Where No. 4 is not used on 5679. No changes.												
5686			No practical substitute.												
5687	6J6	G	Parallel circuits only. Reverse 6J6 to 5687 procedure.												
5691	6SL7 6SN7 5692	E P P	Parallel circuits only. No changes. No changes. No changes.												









**5898-XXL**

**RECEIVING TUBE SUBSTITUTION GUIDE**

TUBE	SUB.	PERF.	CIRCUIT CHANGES NECESSARY
5898	5897	P	No changes.
5899	5840	G	No changes.
	5900	G	
	5901	G	
5900	5840	G	No changes.
	5899	G	
	5901	G	
5901	5840	G	No changes.
	5899	G	
	5900	G	
5910			No practical substitute.
5915	6BE6	E	No changes.
5931			No practical substitute.
5932			No practical substitute.
9001	5590	P	No changes.
	5591	G	
	9003	G	
9002	6AB4	P	Rewire as follows: <div style="display: flex; justify-content: space-around; width: 100%;"> <span>No. 2</span> <span>to No. 7</span> </div> <div style="display: flex; justify-content: space-around; width: 100%;"> <span>5</span> <span>to 1</span> </div>
9003	5590	G	No changes.
	9001	G	
9004			No practical substitute.
9005			No practical substitute.
9006			No practical substitute.
X6030			No practical substitute.
XXFM	7X7	E	No changes.
XXL	6C5	E	Reverse 6J5 to XXL procedure.
	6J5	E	Reverse 6J5 to XXL procedure.
	6K7	E	Reverse 6K7 to XXL procedure.
	7A4	E	No changes.

RECEIVING TUBE SUBSTITUTION GUIDE

ADDENDUM

TUBE.	SUB.	PERF.	CIRCUIT CHANGES NECESSARY																		
6AH6	6AC7	G	<p>Change socket to octal and rewire as follows:</p> <table border="0"> <tr> <td>No. 1 on miniature</td> <td>to No. 4 on octal</td> </tr> <tr> <td>2</td> <td>to 3</td> </tr> <tr> <td>3</td> <td>to 2</td> </tr> <tr> <td>4</td> <td>to 7</td> </tr> <tr> <td>5</td> <td>to 8</td> </tr> <tr> <td>6</td> <td>to 6</td> </tr> <tr> <td>7</td> <td>to 5</td> </tr> </table>   <p>Connect pin 1 on octal to common ground on chassis.</p>	No. 1 on miniature	to No. 4 on octal	2	to 3	3	to 2	4	to 7	5	to 8	6	to 6	7	to 5				
No. 1 on miniature	to No. 4 on octal																				
2	to 3																				
3	to 2																				
4	to 7																				
5	to 8																				
6	to 6																				
7	to 5																				
6AU6	6BJ6	G	Parallel circuits only. Rewire as follows: Interchange leads between pins 2 and 7.																		
6T8	6AL5 } 6AQ6 }	G	The 6T8 is a triple-diode triode tube. If a 6R8 is not available as a substitute, two tubes can be used if space permits. Of the tube combinations listed here one tube is a double diode (the 6AL5) while the other tubes are double-diode triode types. Of the substitute tubes only those elements necessary to perform the required functions are used.																		
	6AL5 } 6AT6 }	G																			
	6AL5 } 6AV6 }	G																			
	6AL5 } 12AV6 }	G																			
12AT7	7F8	G	<p>Change socket to loctal and rewire as follows:</p> <table border="0"> <tr> <td>No. 1 on noval</td> <td>to No. 3 on loctal</td> </tr> <tr> <td>2</td> <td>to 1</td> </tr> <tr> <td>3</td> <td>to 4</td> </tr> <tr> <td>4</td> <td>to 2</td> </tr> <tr> <td>5</td> <td>to 2</td> </tr> <tr> <td>6</td> <td>to 6</td> </tr> <tr> <td>7</td> <td>to 8</td> </tr> <tr> <td>8</td> <td>to 5</td> </tr> <tr> <td>9</td> <td>to 7</td> </tr> </table>  	No. 1 on noval	to No. 3 on loctal	2	to 1	3	to 4	4	to 2	5	to 2	6	to 6	7	to 8	8	to 5	9	to 7
No. 1 on noval	to No. 3 on loctal																				
2	to 1																				
3	to 4																				
4	to 2																				
5	to 2																				
6	to 6																				
7	to 8																				
8	to 5																				
9	to 7																				
12AU7	6SN7	G	<p>Change socket to octal and rewire as follows:</p> <table border="0"> <tr> <td>No. 1 on noval</td> <td>to No. 2 on octal</td> </tr> <tr> <td>2</td> <td>to 1</td> </tr> <tr> <td>3</td> <td>to 3</td> </tr> <tr> <td>4</td> <td>to 7</td> </tr> <tr> <td>5</td> <td>to 7</td> </tr> <tr> <td>6</td> <td>to 5</td> </tr> <tr> <td>7</td> <td>to 4</td> </tr> <tr> <td>8</td> <td>to 6</td> </tr> <tr> <td>9</td> <td>to 8</td> </tr> </table>   <p>The above filament rewiring applies only if the leads from pins 4 and 5 on the noval are tied together or to the same point.</p>	No. 1 on noval	to No. 2 on octal	2	to 1	3	to 3	4	to 7	5	to 7	6	to 5	7	to 4	8	to 6	9	to 8
No. 1 on noval	to No. 2 on octal																				
2	to 1																				
3	to 3																				
4	to 7																				
5	to 7																				
6	to 5																				
7	to 4																				
8	to 6																				
9	to 8																				
	12BH7	G	Parallel circuits only. No changes.																		
1B4	1E5GP	E	No changes.																		
1E5GP	1B4	E	No changes.																		
6C6	1603	E	No changes.																		
	7700	E																			
6F6	1611	E	No changes.																		
6J7	7000	E	No changes.																		

## ADDENDUM

## RECEIVING TUBE SUBSTITUTION GUIDE

TUBE	SUB.	PERF.	CIRCUIT CHANGES NECESSARY
6Y7G	79	G	Reverse 6N7 to 79 procedure.
79	6Y7G	G	Reverse 6N7 to 79 procedure.
1603	6C6 7700	E E	No changes.
1611	6F6	E	No changes.
7000	6J7	E	No changes.
7700	6C6 1603	E E	No changes.

## IDENTICAL TUBES WITH UNLIKE HEATER VOLTAGE AND CURRENT RATINGS

Substitute high voltage tubes for low voltage tubes in series circuits only with suitable shunt resistor when required. Substitute low voltage tubes for high voltage tubes in parallel circuits with voltage dropping resistor in series with filament -- in series circuits with suitable shunt resistor. For all cases see instructions in Section 1. The performance for each substitution is excellent.

TUBE	SUB.	TUBE	SUB.	TUBE	SUB.
2A3	6A3	7B6	14B6	14B8	7B8
2A5	42	7B8	14B8	14E6	7E6
2A6	75	7E6	14E6	14E7	7E7
2A7	6A7	7E7	14E7	14F7	7F7
2B7	6B7	7F7	14F7	14F8	7F8
6A3	2A3	7F8	14F8	14J7	7J7
	1276	7J7	14J7	14N7	7N7
6A6	53	7N7	14N7	14N7	7N7
6A7	2A7	7Q7	14Q7	14Q7	7Q7
6A8	12A8GT	7R7	14R7	14R7	7R7
6B7	2B7	12A8GT	6A8	25B8GT	12B8G
6B8	12C8	12B8G	25B8GT	25L6	1632
6F5	12F5GT	12C8	6B8	30	RK42
6H6	12H6	12F5GT	6F5	42	2A5
6J5	12J5GT	12H6	6H6	53	6A6
6J7	12J7GT	12J5GT	6J5	55	85
6K7	12K7GT	12J7GT	6J7	56	56AS
6K8	12K8	12K7GT	6K7		76
6L6	1631	12K8	6K8	56AS	56
6Q7	12Q7GT	12Q7GT	6Q7		76
6SA7	12SA7	12SA7	6SA7	57	57AS
6SC7	12SC7	12SC7	6SC7	57AS	57
	1634	12SF5	6SF5	58	58AS
6SF5	12SF5	12SF7	6SF7	58AS	58
6SF7	12SF7	12SG7	6SG7	75	2A6
6SG7	12SG7	12SH7	6SH7	76	56
6SH7	12SH7	12SJ7	6SJ7	85	55
6SJ7	12SJ7	12SK7	6SK7	1276	2A3
6SK7	12SK7	12SL7GT	6SL7GT		6A3
6SL7GT	12SL7GT	12SN7GT	6SN7GT	1631	6L6
6SN7GT	12SN7GT		1633	1632	25L6
	1633	12SQ7	6SQ7	1633	6SN7GT
6SQ7	12SQ7	12SR7	6SR7		12SN7GT
6SR7	12SR7	14A4	7A4	1634	6SC7
7A4	14A4	14B6	7B6	RK42	30



# SECTION 3

## TELEVISION RECEIVER FILAMENT CIRCUIT ARRANGEMENT

The filaments of the tubes in most television receivers are either arranged in parallel, series and parallel, or series-parallel circuits. It is necessary to know the filament arrangement of a particular television receiver before some of the tubes in the circuit may be substituted because in many cases, a substitution will involve the addition of a resistor (or other circuit component), or the rearrangement of some part of the filament circuit to make for proper tube operating conditions. For example, the substitution of a tube with a 6.3 volt filament for one with a 12.6 volt filament requires the addition of a series resistor or a shunting resistor depending upon whether the filament is in a parallel or a series circuit respectively. (see Section 1).

In the following section all of the information about filament circuits needed to effect successful substitutions is given for most television receivers. The receivers are listed by model number (or chassis number for those sets having no model number) under the name of the manufacturer. In the second column is found the first page number of the section in the Rider Television Manuals in which all of the servicing information as well as schematics for the

set are given. Under "Type Circuit", a "P" indicates that all of the filaments are in parallel chains across the secondaries of the power and/or filament transformers, an "S,P" indicates that some of the filaments are in parallel chains and some are in series circuits across the line or power transformer, and "S-P" indicates that the filaments are in a series-parallel circuit across the line. Where the filament arrangement is either "S,P" or "S-P", the filament circuit is reproduced at the end of this section, and appears with the number shown in the "Schematic" column. The schematics numbered 1-6 are typical of the majority of parallel filament circuits except for the addition of one or two chains similar to those shown. The schematics 7-35 are reproductions of the "S,P", and "S-P" circuits previously referred to.

The number of circuits or chains into which the filaments of any set are divided appears under the "Number of Chains" column. NOTE: The 1B3 high voltage rectifier circuit has not been included in the number of chains since this rectifier in practically all cases comes off the secondary of the horizontal output transformer.

Model	Rider Man. Page	Type Cir.	No. of Chains	Sch.	Model	Rider Man. Page	Type Cir.	No. of Chains	Sch.
<u>ADMIRAL CORP.</u>					<u>ADMIRAL CORP. (Cont'd)</u>				
4H15A, 4H15B, Ch. 20A1; 4J1, Radio Ch.	4-1	P	2	1	4H146A, 4H146B, Ch. 20B1; 4J1, Radio Ch.	4-1	P	2	1
4H15S, 4H15SN, Ch. 30A1, 30B1, 30C1, 30D1; 4H1, Radio Ch.	3-17	P	5	3	4H146C, Ch. 20B1; 4K1, Radio Ch.	4-1	P	2	1
4H16A, 4H16B, Ch. 20A1; 4J1, Radio Ch.	4-1	P	2	1	4H146S, 4H146SN, Ch. 30A1, 30B1, 30C1, 30D1; 4H1, Radio Ch.	3-17	P	5	3
4H16S, 4H16SN, Ch. 30A1, 30B1, 30C1, 30D1; 4H1, Radio Ch.	3-17	P	5	3	4H147A, 4H147B, Ch. 20B1; 4J1, Radio Ch.	4-1	P	2	1
4H17A, 4H17B, Ch. 20A1; 4J1, Radio Ch.	4-1	P	2	1	4H147S, 4H147SN, 4H155S, 4H155SN, Ch. 30A1, 30B1, 30C1, 30D1, 4H1, Radio Ch.	3-17	P	5	3
4H18C, 4H18CN, Ch. 20B1; 4K1, Radio Ch.	4-1	P	2	1	4H156C, 4H156CN, Ch. 20B1; 4K1, Radio Ch.	4-1	P	2	1
4H18S, 4H18SN, Ch. 30A1, 30B1, 30C1, 30D1; 4H1, Radio Ch.	3-17	P	5	3	4H156S, 4H156SN, Ch. 30A1, 30B1, 30C1, 30D1; 4H1, Radio Ch.	3-17	P	5	3
4H19C, 4H19CN, Ch. 20B1; 4K1, Radio Ch.	4-1	P	2	1	4H157A, 4H157B, Ch. 20B1; 4J1, Radio Ch.	4-1	P	2	1
4H19S, 4H19SN, Ch. 30A1, 30B1, 30C1, 30D1; 4H1, Radio Ch.	3-17	P	5	3	4H157S, 4H157SN, Ch. 30A1, 30B1, 30C1, 30D1; 4H1, Radio Ch.	3-17	P	5	3
4H115S, 4H115SN, 4H116S, 4H116SN, 4H117S, 4H117SN, Ch. 30A1, 30B1, 30C1, 30D1; 4H1, Radio Ch.	3-17	P	5	3	4H165A, 4H165B, Ch. 20B1; 4J1, Radio Ch.	4-1	P	2	1
4H126A, 4H126B, Ch. 21A1; 4J1, Radio Ch.	4-1	P	2	1	4H165S, 4H165SN, Ch. 30A1, 30B1, 30C1, 30D1; 4H1, Radio Ch.	3-17	P	5	3
4H126C, 4H126CN, Ch. 21A1; 4K1, Radio Ch.	4-1	P	2	1	4H166A, 4H166B, Ch. 20B1; 4J1, Radio Ch.	4-1	P	2	1
4H126S, 4H126SN, Ch. 30A1, 30B1, 30C1, 30D1; 4H1, Radio Ch.	3-17	P	5	3	4H166C, 4H166CN, Ch. 20B1; 4K1, Radio Ch.	4-1	P	2	1
4H137A, 4H137B, Ch. 21A1; 4J1, Radio Ch.	4-1	P	2	1	4H166S, 4H166SN, Ch. 30A1, 30B1, 30C1, 30D1; 4H1, Radio Ch.	3-17	P	5	3
4H137S, 4H137SN, Ch. 30A1, 30B1, 30C1, 30D1; 4H1, Radio Ch.	3-17	P	5	3	4H167A, 4H167B, Ch. 20B1; 4J1, Radio Ch.	4-1	P	2	1
4H145A, 4H145B, Ch. 20B1; 4J1, Radio Ch.	4-1	P	2	1	4H167C, 4H167CN, Ch. 20B1; 4K1, Radio Ch.	4-1	P	2	1
4H145C, 4H145CN, Ch. 20B1; 4K1, Radio Ch.	4-1	P	2	1					
4H145S, 4H145SN, Ch. 30A1, 30B1, 30C1, 30D1; 4H1, Radio Ch.	3-17	P	5	3					

## RECEIVING TUBE SUBSTITUTION GUIDE

Model	Rider Man. Page	Type	No. of Cir.	Sch.	Model	Rider Man. Page	Type	No. of Cir.	Sch.
<u>ADMIRAL CORP. (Cont'd)</u>					<u>ADMIRAL CORP. (Cont'd)</u>				
4H167S, 4H167SN, Ch. 30A1, 30B1, 30C1, 30D1; 4H1, Radio Ch.	3-17	P	5	3	30F16A, Ch. 20B1; 4K1, Radio Ch.	4-1	P	2	1
8C11, Ch. 30A1; 8C1, Radio Ch.	2-1	P	5	3	30F17, Ch. 20B1; 4J1, Radio Ch.	4-1	P	2	1
8C11, 8C11N, 8C11S, 8C11SN, 8C11T, 8C11TN, 8C11UL, Ch. 30A1, 30B1, 30C1, 30D1; 4H1, Radio Ch.	3-17	P	5	3	30F17A, Ch. 20B1; 4K1, Radio Ch.	4-1	P	2	1
8C12, Ch. 30A1; 8C1, Radio Ch.	2-1	P	5	3	36X36, 36X37, Ch. 24E1; 39X16, 39X17, Ch. 24G1	4-1	P	3	2
8C12, 8C12N, 8C12S, 8C12SN, 8C12T, 8C12TN, 8C12UL, Ch. 30A1, 30B1, 30C1, 30D1; 4H1, Radio Ch.	3-17	P	5	3	<u>AFFILIATED RETAILERS, INC.</u>				
8C13, Ch. 30A1; 8C1, Radio Ch.	2-1	P	5	3	AR-TV-10C, AR-TV-12X, AR-TV-12X	3-1	P	3	4
8C13, 8C13N, 8C13S, 8C13SN, 8C13T, 8C13TN, 8C13UL, Ch. 30A1, 30B1, 30C1, 30D1; 4H1, Radio Ch.	3-17	P	5	3	AR-23-TV-1	3-8	P	3	2
19A11S, 19A11SN, 19A12S, 19A12SN, 19A15S, 19A15SN, Ch. 19A1	3-1	P	2	1	16CX, 816, 816CR	5-1	P	3	4
20X11, 20X12, 20X122, Ch. 20X1; 4L1, Radio Ch.	4-38	P	2	1	<u>AIR KING PRODUCTS CO., INC.</u>				
20X136, 20X145, 20X146, 20X147, Ch. 20Y1; 4L1, Radio Ch.	4-38	P	2	1	A-1000	2-1	P	3	5
24A12, 24A125, Ch. 20A1	4-1	P	2	1	A-1001-A, A-2000, A-2001, A-2002	3-1	P	2	1
24A125AN, Ch. 20X1; 4L1, Radio Ch.	4-38	P	2	1	12C1, 12T1, 12T2, Ch. 700	5-1	P	2	1
24C15, 24C16, Ch. 20B1	4-1	P	2	1	16C1, Ch. 700-1	5-3	P	3	2
24X15, 24X15S, 24X16, 24X16S, 24X17S, Ch. 20X1; 4L1, Radio Ch.	4-38	P	2	1	16C2, Ch. 700-1	5-3	P	3	2
25A15, 25A16, 25A17, Ch. 21A1	4-1	P	2	1	16K1, Ch. 700-2; 507, Radio Ch.	5-3	P	3	2
26X35, 26X36, 26X37, Ch. 24D1; 29X16, 29X17, Ch. 24F1	4-1	P	3	2	16T1, Ch. 700-1	5-3	P	3	2
30A12, 30A12N, 30A12S, 30A12SN, 30A12T, 30A12TN, 30A12UL, 30A13, 30A13N, 30A13S, 30A13SN, 30A13T, 30A13TN, 30A13UL, 30A14, 30A14N, 30A14S, 30A14SA, 30A14SN, 30A14T, 30A14TN, 30A14UL, Ch. 30A1, 30B1, 30C1, 30D1; 4H1, Radio Ch.	3-17	P	5	3	712, Ch. 700	5-1	P	2	1
30A15	1-1	P	5	3	718R, Ch. 700-1	5-3	P	3	2
30A15, 30A15N, 30A15S, 30A15SA, 30A15SN, 30A15T, 30A15TN, 30A15UL, Ch. 30A1, 30B1, 30C1, 30D1; 4H1, Radio Ch.	3-17	P	5	3	<u>ALLIED PURCHASING CORP. DIV. OF ALLIED STORES</u>				
30A16	1-1	P	5	3	G-16, V16, 616, 816, Same as Tele-King 616	5-1	P	3	4
30A16, 30A16N, 30A16S, 30A16SN, 30A16T, 30A16TN, 30A16UL, Ch. 30A1, 30B1, 30C1, 30D1; 4H1, Radio Ch.	3-17	P	5	3	910, Same as Tele-King 510	4-1	P	3	4
30B15S, 30B15SN, 30B16S, 30B16SN, 30B17S, 30B17SN, Ch. 30A1, 30B1, 30C1, 30D1; 4H1, Radio Ch.	3-17	P	5	3	912, Same as Tele-King 512	3-1	P	3	4
30C15S, 30C15SN, 30C16S, 30C16SN, 30C17S, 30C17SN, Ch. 30A1, 30B1, 30C1, 30D1; 4H1, Radio Ch.	3-17	P	5	3	1012, Same as Tele-King 612	3-1	P	3	4
30F15, Ch. 20B1; 4J1, Radio Ch.	4-1	P	2	1	<u>ALTEC LANSING CORP.</u>				
30F15A, Ch. 20B1; 4K1, Radio Ch.	4-1	P	2	1	ALC201	3-1	P	4	6
30F16, Ch. 20B1; 4J1, Radio Ch.	4-1	P	2	1	202A	4-1	P	3	2
					205	4-2	P	3	2
					<u>ANDREA RADIO CORP.</u>				
					BCO-VJ12-2, Ch. VJ12-2	2-3	P	5	3
					BCO-VJ15, Ch. VJ15	2-3	P	5	3
					BT-VK12, Ch. VK12	2-8	P	5	3
					C-VJ12, CO-VJ12, Ch. VJ12, CO-VJ12-2, Ch. VJ12-2	2-3	P	5	3
					CO-VJ15, Ch. VJ15	2-3	P	5	3
					CO-VK15, Corinthian; CO-VK16, Caronia; Ch. VK15-16	2-8	P	5	3
					CO-VK16 Late, Caronia, Ch. VK-19	2-8	P	5	3
					CO-VK16"C", Dynasty, Ch. VK15-16	2-8	P	5	3

## RECEIVING TUBE SUBSTITUTION GUIDE

Model	Rider				Model	Rider			
	Man. Page	Type Cir.	No. of Chains	Sch.		Man. Page	Type Cir.	No. of Chains	Sch.
<u>ANDREA RADIO CORP. (Cont'd)</u>					<u>BACE TELEVISION CORP. (Cont'd)</u>				
CO-VK124, Edgemont, Ch. VK124	2-8	P	5	3	160TM	2-1	P	3	5
CO-VK125, Ridgeway, Ch. VK12	2-8	P	5	3	190-K, 190-KFD, 190KHD	2-1	P	3	5
CVK19, Normandy, Ch. VK-19	2-8	P	5	3	<u>BAGDAD TELEVISION CO., INC.</u>				
CVK-126, Gramercy, Ch. VK12	2-8	P	5	3	19 Tube Set	2-1	P	2	1
T-VJ12, Ch. VJ12	1-1	P	5	3	<u>BELL TELEVISION, INC.</u>				
TVK12, Saratoga; TVK-127, Sharron; Ch. VK12	2-8	P	5	3	16DD, 16T, 16TD, 19DD, 19T, 19TD, 1502, 1503, 2002, 2003	4-1	P	3	5
<u>ANSLEY RADIO &amp; TELEV., INC.</u>					<u>BELMONT RADIO CORP. (RAYTHEON)</u>				
701	2-1	P	3	5	Coronet	3-1	S-P	9	10
702, 113 AM-FM, Radio	2-2	P	3	5	Observer	3-1	S-P	3	9
717, 718, 725, Ch. P-101	4-1	P	3	5	A-7DX22-P, Series A	4-1	S-P	3	9
<u>ASSOCIATED MERCHANTS CORP.</u>					A-10DX22, Observer; A-10DX24, Ch. A, B, C, D; Radio Ch.	3-1	S-P	6	10
AM510, Same as Tele-King 510	4-1	P	3	4	B-10DX22, Ch. A, B, C, D; Radio Ch.	3-1	S-P	6	10
AM712, Same as Tele-King 712	4-1	P	3	4	C-1102, Ch. 12AX22	4-6	P	2	1
<u>THE ASTATIC CORP.</u>					C-1104B, Ch. 12AX27	5-1	P	3	2
AT-1, Booster	4-1	P	1		C-1401, Ch. 14AX21	5-9	P	3	2
<u>ATWATER TELEVISION CO.</u>					C-1602, Ch. 16AX23, 16AX25, 16AX26	5-21	P	2	1
135, 513	5-1	P	3	2	7DX21	2-6	S-P	3	9
<u>AUTOMATIC RADIO MFG. CO., INC.</u>					7DX21, Series B	2-6	S-P	3	9
AR-TV-709	2-1	S-P	2	7	10AXF43, Ch. A, B, C, D; Radio Ch.	3-1	S-P	3	9
TV-12-49, TV-12-50	4-1	S-P	3	8	10DX21, Ch. A, B, C, D; Radio Ch.	2-1	S-P	6	10
TV-16-49, TV-16-50, TV-16-51	3-1	P	3	2	10DX22, 10DX24, Coronet, Ch. A, B, C, D; Radio Ch.	31-1	S-P	6	10
TV-1205	5-5	S-P	3	8	18DX21	2-6	S-P	3	9
TV-1205, Series B	5-1	P	1		18DX21A	2-6	S-P	3	9
TV-1294	5-5	S-P	3	8	21A21	1-1	P	2	1
TV-1294, Series B	5-1	P	1		22A21, 22AX21, 22AX22	1-25	P	2	1
TV-1605, TV-1615	5-5	S-P	3	8	<u>BENDIX RADIO DIV.</u>				
TV-1649, TV-1650, TV-1651, Series B	5-6	P	3	2	235B1	2-1	P	2	1
TV-1694	5-5	S-P	3	8	235B1, Codes A, B, C, D, E, F, G, H, I, J, K, L, M, MA, MB, MC, MD	3-1	P	2	1
TV-5001	5-2	P	1		23M1	2-1	P	2	1
TV-5006	5-2	P	1		325M8, Codes A, B, C, D, E, F, G, H, I, J, K, L, M, MA, MB, MC, MD	3-1	P	2	1
TV-5012	5-2	P	1		2001, 2002, 2020, 2021; 2000 Series	3-21	P	3	2
TV-5061, TV-5077	5-2	P	1		2025	4-1	P	3	2
TV-5111	5-2	P	1		2051	5-1	P	3	2
<u>BACE TELEVISION CORP.</u>					3001, 3002, 3030, 3031; 3000 Series	3-21	P	3	2
16 RCC, 16 RCH, 19 RCC, 19 RCH	4-1	P	5	3	3033	4-1	P	3	2
150-D	2-1	P	5	1&5					
160C	2-1	P	3	5					
160-K	2-1	P	3	5					

## RECEIVING TUBE SUBSTITUTION GUIDE

Model	Rider				Model	Rider			
	Man. Page	Type Cir.	No. of Chains	Sch.		Man. Page	Type Cir.	No. of Chains	Sch.
<u>BENDIX RADIO DIV. (Cont'd)</u>					<u>CROSLEY DIV. AVCO MFG. CORP. (Cont'd)</u>				
3051, 6001	5-1	P	3	2	9-413B, 9-413B-2	3-1	P	4	6
6002	4-1	P	3	2	9-414B	4-1	P	4	6
6003	5-1	P	3	2	9-419M1-LD, 9-419M3-LD	4-26	P	3	2
6100	5-1	P	3	2	9-420M	4-38	P	4	6
<u>BRUNSWICK See RADIO &amp; TELEVISION INC.</u>					9-422M, 9-422MA				
<u>BUD RADIO CO.</u>					9-422M-LD				
TAB-98, Booster	2-1	P	1		9-423M	4-59	P	4	6
TAB-99, PreAmp	2-1	P	1		9-423M-LD	5-14	P	4	6
<u>CALBEST ENGINEERING &amp; ELECTRONICS CO.</u>					9-424B				
5082, 5086, 5086R, 5089, 5089R	5-1	P	3	2	9-425	3-9	P	3	4
<u>CAPEHART-FARNSWORTH CORP. Also See FARNSWORTH TELEV. &amp; RADIO CORP</u>					10-401				
3001-B, 3001-M, 3002-B, 3002-M, Ch. C-272; Ch. CX-30	4-1	S,P	3	15	10-414MU, 10-416MU, 10-416M1U	5-37	P	4	6
3004-M, Ch. C-268; 3006-M, Ch. C-274; CX-31	4-17	P	3	2	10-419MU	5-42	P	3	4
3007-M, Ch. C-276; Ch. CX-30	4-1	S,P	3	15	307TA, 307TA-50	1-1	P	3	5
3011-B, 3011-M, 3012-B, 3012-M, Ch. C-281; Ch. CX-33	5-1	P	2	1	348CP, Ch. TR1, TR2, TR3	2-15	P	3	6
4001-M, Ch. C-268; 4002-M, Ch. C-274; Ch. CX-31	4-17	P	3	2	<u>THE DENMAR TELEVISION CO.</u>				
<u>CERTIFIED RADIO LABORATORIES</u>					630-HV				
47-71	1-1	P	3	2	<u>DE WILD RADIO MFG. CORP.</u>				
48-10	1-1	P	3	2	BT-100, BT-101	2-1	P	3	5
49-10	2-1	P	3	2	CT-101	3-1	P	3	5
49-710	2-1	P	3	2	CT-102, CT-103, CT-104	3-2	P	5	3
4920	4-1	P	4	6	DT-120	4-1	P	5	3
<u>CERTIFIED TELEVISION LABORATORIES See CERTIFIED RADIO LABORATORIES</u>					DT-161				
<u>CLEERVUE TELEVISION CORP.</u>					DT-1020, DT-1030, DT-X-160				
Hollywood, Regency	1-1	P	3	5	<u>ALLEN B. DUMONT LABORATORIES, INC.</u>				
<u>CONSOLIDATED TELEVISION CORP. Also See TELE-KING CORP.</u>					Inputuner				
2315	1-1	P	1		RA-101, Devonshire, Hampshire, Plymouth, Revere, Sherwood, Westminster	1-7	P	6	4&5
<u>CORNELL TELEVISION, INC. See VIDEO CORP. OF AMERICA</u>					RA-101-B				
<u>CROSLEY DIV. AVCO MFG. CORP.</u>					RA-102, RA-102-B1, RA-102-B2, RA-102-B3, Clifton, Club				
9-403M, 9-403MA, 9-403M-2	3-1	P	4	6	RA-103, Chatham, Savoy	1-58	P	3	2
9-404M	4-1	P	4	6	RA-103-D, Canterbury, Rumson, Sheffield; RA-104-A, Hastings, Wellington	3-1	P	4	6
9-407, 9-407M, 9-407-1, 9-407M-2, 9-407M-3	2-1	P	2	2	RA-105, Colony, Stratford, Westbury, Whitehall	2-5	P	4	5
9-409M3-LD	4-13	P	3	2	RA-105-B, Sussex	4-5	P	4	5
					RA-106, Club 20	2-34	P	4	5
					RA-108-A, Bradford, Mansfield	4-5	P	5	5&1

## RECEIVING TUBE SUBSTITUTION GUIDE

Model	Rider				Model	Rider			
	Man. Page	Type	No. of Cir.	No. of Chains Sch.		Man. Page	Type	No. of Cir.	No. of Chains Sch.
<u>ALLEN B. DUMONT LABORATORIES, INC. (Cont'd)</u>					<u>EMERSON RADIO &amp; PHONO. CORP. (Cont'd)</u>				
RA-110-A, Fairfield, Westwood	3-1	P	4	6	651D, 658B, Ch. 120124B	5-27	P	3	4
<u>DYNAMIC TELEV. ASSOCIATES, INC.</u>					470606, Tuner	5-1	P	1	
TU-10C	2-1	P	3	2	<u>ESPEY MFG. CO., INC.</u>				
<u>ELECTROMATIC MFG. CORP.</u>					3-Inch Kit	1-1	P	3	2
101, 120-A	5-1	S-P	3	11	<u>FADA RADIO &amp; ELECTRIC CO., INC.</u>				
<u>ELECTRO-TECHNICAL INDUSTRIES</u> (TELEKIT)					R-1025, R-1050	5-1	P	3	5
7 Telekit	1-1	P	3	2	TV-30	2-1	P	3	5
7-A	2-1	P	4	6	799	2-1	P	3	5
7B	3-1	P	4	6	880	3-1	P	3	5
10 Telekit	1-23	P	6	3	895; 891, Radio Ch.	4-7	P	3	5
10-A	2-11	P	4	5	899	2-1	P	3	5
10B	4-8	P	4	6	925	4-1	P	3	5
13B-KT Tuner; 16CK, Conversion Kit	4-14	P	1		930, 940	3-20	P	3	5
<u>EMERSON RADIO &amp; PHONO. CORP.</u>					965	4-1	P	3	5
527, Ch. 120019	1-1	P	3	4	<u>FARNSWORTH TELEV. &amp; RADIO CORP.</u> Also See CAPEHART-FARNSWORTH CORP.				
545, Ch. 120047	1-8	P	3	2	GV-260	1-1	P	4	3
571, Ch. 66B	2-1	S-P	3	12	U-12-A, Capehart	2-9	P	3	2
571, Ch. 86B	2-1	S,P	3	12	504P16, Ch. U-12	2-9	P	3	2
585, Ch. 120025B, 120088B; 120024B, 120081B, Radio Ch.	3-1 3-11	S,P S	3 1	12	651-P	2-1	P	4	3
600, Ch. 120103B	4-1	S-P	3	13	661-P	2-1	P	4	3
606, Ch. 66B	2-1	S-P	3	12	<u>FEDERAL TELEVISION CORP.</u>				
606, Ch. 86B	2-1	S,P	3	12	1501TV	4-1	P	3	2
608, Ch. 120089B	3-19	P	3	4	<u>FEDERAL VIDEO CORP.</u>				
611, Ch. 87B	2-1	P	2	1	209, 309, 409, Ch. 31	3-1	P	3	5
614, Ch. 120110B, 120110C	4-9	P	3	4	<u>FERGUSON RADIO, INC.</u>				
618, Ch. 120090B, 120090D; 120081B, Radio Ch.	3-1 3-11	P S	2 1	1	749PTV, 749TV	3-1	S-P	3	16
621, Ch. 120098B; 622, Ch. 120098P	4-21	P	3	4	1049TVT	3-2	P	3	2
626, Ch. 120104B, 120104BJ	3-19	P	2	1	<u>THE FIRESTONE TIRE &amp; RUBBER CO.</u>				
628, Ch. 120098B	4-21	P	3	4	13-G-3	3-1	S-P	2	17
629D, Ch. 120124B	5-27	P	3	4	13-G-4	4-1	P	4	6
630, Ch. 120099B	4-21	P	3	4	13-G-5	3-5	P	4	3
631, Ch. 120109B; 632, Ch. 120096B; 633, Ch. 120114B	5-6	P	3	4	13-G-33	4-6	S-P	2	17
637, Ch. 120110B, 120110C	4-9	P	3	4	<u>FREED-EISEMANN</u> See FREED RADIO CORP.				
639, Ch. 120103B	4-1	S-P	3	13	<u>FREED RADIO CORP.</u> (FREED-EISEMANN)				
644, 647, Ch. 120113B, 120113C	4-9	P	3	4	55, Ch. 1620C	5-1	P	4	5
648B, Ch. 120110-E	4-9	P	3	4	56, Ch. 1620	3-1	P	4	5
650, Ch. 120113B, 120113C	4-9	S,P	4	14	77, Ch. 1610	3-1	P	4	5

## RECEIVING TUBE SUBSTITUTION GUIDE

Model	Rider				Model	Rider			
	Man. Page	Type Cir.	No. of Chains	Sch.		Man. Page	Type Cir.	No. of Chains	Sch.
<u>GAMBLE- SKOGMO, INC.</u>					<u>GAROD RADIO CORP. (Cont'd)</u>				
FA43-8965A, FA43-8965B	3-1	S-P	3	9	2043T	4-10	P	3	4
FA43-8966	4-1	S-P	6	10	2546T	4-10	P	3	4
TV43-8908	4-15	P	3	2	2547T	4-10	P	3	4
TV43-8960	3-10	P	3	2	2548T	4-10	P	3	4
94TV1-43-8940A	4-21	P	2	1	2549T	4-10	P	3	4
94TV2-43-8970A, 94TV2-43-8971A	3-17	P	4	6	3912TVFMP; 11FMT, Radio	1-1	P	4	6
94TV6-43-8953A	5-9	P	3	2	3915TVFMP; 9FMT, Radio	2-12	P	4	6
<u>GAROD RADIO CORP.</u>					<u>GENERAL ELECTRIC CO.</u>				
10TZ20, Ambassador; 10TZ21, Malibu; 10TZ22, Monticello; 10TZ23, Catalina	4-5	P	4	6	HM-171	1-1	P	3	2
12TZ20, Belvedere; 12TZ21, Claridge; 12TZ22, Caronet; 12TZ23, Carlton	4-5	P	4	6	HM-185	1-3	P	3	2
15TZ24, 15TZ25, 15TZ26, 15TZ27	4-5	P	4	6	HM-225, HM-225B	1-14	P	2	1
19C6, 19C7	5-18	P	3	4	HM-226B, HM-226-7A	1-14	P	2	1
900 Series	2-1	P	4	6	10C101, 10C102, 10T1, 10T4, 10T5, 10T6	5-1	S-P	2	19
1000	2-1	P	4	6	12C101, 12C102, 12C105	5-25	S-P	2	19
1042G	3-7	P	3	4	12C107, 12C108, 12C109	5-35	S-P	2	20
1042T	4-10	P	3	4	12C107, 12C108, 12C109, B Version	5-35	S-P	2	20
1043G	3-7	P	3	4	12K1	5-12	S-P	2	19
1043T	4-10	P	3	4	12T1	5-25	S-P	2	19
1100	2-1	P	4	6	12T3, 12T4	5-35	S-P	2	20
1142	4-1	P	3	4	12T3, 12T4, B Version	5-35	S-P	2	20
1143	4-1	P	3	4	800A, 800B, 800C, 800D	4-1	S-P	2	18
1200	2-1	P	4	6	801, Early, Late	1-28	P	3	2
1244T	4-10	P	3	4	802	1-52	P	4	6
1245T	4-10	P	3	4	803	2-1	P	4	6
1344	4-1	P	3	4	805, Early, S, T, U, W, Versions	3-1	S-P	2	18
1345	4-1	P	3	4	806, 807, Early, S, T, U, W, Versions	3-1	S-P	2	18
1546T	4-10	P	3	4	809, Early, S, T, U, W, Versions	3-1	S-P	2	18
1547T	4-10	P	3	4	810	2-11	P	5	5
1548T	4-10	P	3	4	811	2-11	P	5	5
1549T	4-10	P	3	4	814	2-22	P	5	5
1646	4-1	P	3	4	817, S, T, U, W, Versions	4-9	S-P	2	18
1647	4-1	P	3	4	818	4-24	S-P	2	18
1648	4-1	P	3	4	820	3-16	P	5	5
1649	4-1	P	3	4	821, S, T, U, W, Versions	4-9	S-P	2	18
1671	5-15	P	3	4	830, Early, R, T, Versions	3-31	P	5	5
1672, 1673, 1674, 1675, 1974, 1975	5-18	P	3	4	835, Early, R, Versions	3-45	P	4	5
2042T	4-10	P	3	4	840	4-34	P	5	5
					901, Preliminary	1-73	P	5	3

## RECEIVING TUBE SUBSTITUTION GUIDE

Model	Rider				Model	Rider			
	Man. Page	Type	No. of Chains	Sch.		Man. Page	Type	No. of Chains	Sch.
<u>GENERAL ELECTRIC CO. (Cont'd)</u>					<u>INDUSTRIAL TELEV., INC. (Cont'd)</u>				
901, Final	2-32	P	5	3	IT-13R	2-1	P	4	6
910, Preliminary	1-73	P	5	3	IT-15R, Guest Television	2-4	P	2	1
910, Final	2-32	P	5	3	IT-21R, IT-21R-1, IT-21R-2, Ch.	4-1	P	3	4
<u>GENERAL INSTRUMENT CORP.</u>					IT-22R	2-6	P	3	2
TVA	3-1	P	1		IT-26R	3-1	P	7	2&6
TVB	2-1	P	1		IT-35R	3-1	P	7	2&6
TVB Revised, TVC	3-1	P	1		IT-39R, IT-40R, IT-42R, IT-46R	3-1	P	7	2&6
44, Revised	5-1	P	1		IT-48R-1-2-3-4	5-1	P	3	2
44TV, Tuner	4-1	P	1		326	3-1	P	7	2&6
<u>GILFILLAN BROS., INC.</u>					721, 821, 921, 1021	4-1	P	3	4
339-59A	1-1	P	3	2	<u>INTERNATIONAL TELEV. CORP.</u>				
<u>GUTHMAN INTERNATIONAL CORP.</u>					D16	3-1	P	3	5
34-1024, Tuner	3-1	P	1		E-16	4-1	P	2	1
<u>THE HALLICRAFTERS CO.</u>					<u>INTERSTATE STORES BUYING CORP. (PLYMOUTH)</u>				
T-54	1-1	S-P	2	21	IS510, Same as Tele-King 510	4-1	P	3	4
T-60	4-1	P	3	2	IS812, Same as Tele-King 512	3-1	P	3	4
T-68	4-1	P	3	2	250, 350, 750	5-1	P	3	2
505	1-1	S-P	2	21	<u>JACKSON INDUSTRIES, INC.</u>				
515	3-8	P	3	2	5000TV, 5050CTV, 5200TV, 5250CTV, 5600TV, 5650CTV	3-1	P	2	1
600, 601, 602	4-18	P	3	2	<u>JAMAICA RADIO TELE. MFG. CO.</u>				
716, 717, 730, 731, 740, 741, Ch. C919120	5-1	P	3	2	RTP	3-1	P	2	1
<u>HOFFMAN RADIO CORP.</u>					WBS, DeLuxe	3-2	P	2	1
CT-800, CT-801, CT-900, CT-901	2-1	P	3	5	<u>JERROLD ELECTRONICS CORP.</u>				
610, Ch. 140	3-1	P	3	2	TV-FM, Booster	2-1	P	1	
612, Ch. 142	3-1	P	3	2	TV-FM, Series B, Booster	3-1	P	1	
820, 821, 822, Ch. 146; 826, 827, 828, Ch. 143	3-1	P	3	2	<u>KAYE-HALBERT</u> See <u>TELINDUSTRIES, INC.</u>				
912, 913, Ch. 147	3-1	P	3	2	<u>MAY'S</u>				
<u>HOWARD RADIO CO.</u>					Bryant, Classic, Corner Cab, Queen Anne, Regency, Trafalgar; Same as Shevers 032-16	5-1	P	3	5
475-TV	2-1	P	3	5	1016, 1019, Queen Anne; 2016, 2019, Regency; 3016, 3019, Trafalgar; 4016, 4019, Classic; 5016, 5019, Bryant; 6016, 6019, Corner Cab; Same as Shevers 032-16	5-1	P	3	5
<u>I.D.E.A.</u> See <u>INDUSTRIAL DEVELOPMENT ENG. ASSOCIATES, INC.</u>					<u>THE MAGNAVOX CO.</u>				
<u>INDUSTRIAL DEVELOPMENT ENG. ASSOCIATES, INC. (I.D.E.A.)</u>					CT-214A	2-1	P	3	2
Regency	4-1	P	1		CT-214B	2-1	P	3	2
DB-213, Regency	4-1	P	1		CT-219	2-1	P	3	2
<u>INDUSTRIAL TELEV., INC.</u>					CT-219, CT-220	3-1	P	3	2
IT-1R	1-1	P	6	2&5					
IT-3R	1-11	P	7	4					
IT-11R	2-1	P	4	6					

## RECEIVING TUBE SUBSTITUTION GUIDE

Model	Rider				Model	Rider			
	Man. Page	Type Cir.	No. of Chains	Sch.		Man. Page	Type Cir.	No. of Chains	Sch.
<u>THE MAGNAVOX CO. (Cont'd)</u>					<u>MONTGOMERY WARD (Cont'd)</u>				
CT-221	2-1	P	3	2	84HA-3010A, 84HA-3010B, 84HA-3010C	5-1	P	3	2
CT-222	3-1	P	3	2	94BR-3004, 94BR-3004C, 94BR-3004D, 94BR-3005, 94BR-3005C	5-10	S-P	3	9
CT-224, CT-235	4-1	P	2	1	94BR-3004E	5-10	S-P	3	10
CT-237, CT-238	3-1	P	3	2	94BR-3017A	3-11	S-P	3	9
MCT 228	4-14	P	3	2	94BR-3021A, 94BR-3024A, Code 1	4-17	P	2	1
<u>MAJESTIC RADIO &amp; TELEV. CORP.</u>					<u>MOTOROLA INC.</u>				
7TV850, Ch. 18C90	3-1	P	2	1	94GSE-3015A	4-22	P	3	4
<u>MAJESTIC RADIO AND TELEVISION, INC.</u>					<u>MOTOROLA INC.</u>				
19C6, 19C7, 1672, 1673, 1674, 1675, 1974, 1975	5-12	P	3	4	94GSE-3018A	5-29	P	3	4
<u>MARS TELEVISION INC.</u>					<u>MOTOROLA INC.</u>				
1200	2-1	P	3	5	94GSE-3025A, 94GSE-3033A	5-38	P	4	3
<u>MASCO</u>					<u>MOTOROLA INC.</u>				
See MARK SIMPSON MFG. CO., INC.					VF102, VF102-A, VF102-C, Ch. TS-7; HS-108, Radio Ch.				
<u>JOHN MECK INDUSTRIES, INC.</u>					VF103, VF103M, Ch. TS-8				
XA-701, XB-702, XC-703	3-1	S-P	3	16	VK101, Early, Late, Ch. TS-3	1-53	P	5	3
XL-750	3-1	P	3	2	VK106, Ch. TS-9, TS-9B, Revised	2-27	S, P	3	12
XM-751, XN-752, XQ-774, XQ-776, XR-778, XS-786, XT-785	4-1	P	3	4	VK106, Ch. TS-9A, TS-9B, TS-9D	3-1	P	4	6
<u>MEISSNER MFG. DIV.</u>					VX106B, VX106M, Ch. TS-9, TS-9B				
<u>MAGUIRE INDUSTRIES, INC.</u>					VX106B, VX106M, Ch. TS-9B, TS-9C, TS-9D				
24TV	2-1	P	3	2	VT71, Ch. TS-4	1-1	S-P	3	22
25TV	4-1	P	3	2	VT71, Ch. TS-4B; TS-4C, TS-4D, TS-4E, TS-4F, TS-4G, TS-4H, TS-4J	2-34	S-P	3	24
<u>MERRICK TELEVISION CO.</u>					<u>MOTOROLA INC.</u>				
Visionmaster	2-1	P	4	6	VT105, Ch. TS-9A, TS-9C, TS-9D	3-1	P	4	6
<u>MIDWEST RADIO &amp; TELEV. CORP.</u>					<u>MOTOROLA INC.</u>				
JR-32, Ch. CJ-32, CR-30	4-11	P	2	1	VT105M, Ch. TS-9, TS-9B; Revised	2-27	S, P	3	12
JX-26, JXA-24, Ch. CX-26, CXA-24	4-5	P	2	1	VT105M, Ch. TS-9A, TS-9C; TS-9D	3-1	P	4	6
MX-22, MXA-20, Ch. CM-22, CMA-20	4-1	P	2	1	VT107, Ch. TS-9, TS-9B; Revised	2-27	S, P	3	12
TRC-12, Ch. TR12	4-16	P	4	6	VT107, Ch. TS-9A, TS-9C; TS-9D	3-1	P	4	6
XA-12, Ch. CA-12; XT-12, Ch. CT-12	3-1	P	4	5	VT107M, Ch. TS-9, TS-9B; Revised	2-27	S, P	3	12
932, Ch. CA-12; 936, Ch. CT-12	3-1	P	3	2	VT107M, Ch. TS-9A, TS-9C; TS-9D	3-1	P	4	6
945, Ch. TR12	4-16	P	3	2	VT121, Ch. TS-15, TS-15A, TS-15B, TS-15C, TS-15C1	3-26	P	5	6
<u>MITUS, INC.</u>					<u>MOTOROLA INC.</u>				
Master No. 2 System	1-1	P	5	3	7VT1, 7VT2, 7VT5, Ch. TS-18, TS-18A	4-11	S-P	3	26
<u>MONTGOMERY WARD</u>					<u>MOTOROLA INC.</u>				
84GSE-3011A	4-1	P	3	4	10T2, Ch. TS-14B	4-19	P	3	4
84HA-3002A	3-1	S-P	3	25	10VK9, 10VT3, Ch. TS-9E, TS-9D1	3-18	P	4	6
84HA-3002B	3-6	S-P	3	25	10VK12, 10VK12R, 10VK22R, 10VT10, 10VT10B, 10VT10R, 10VT24R, Ch. TS-14, TS-14A, TS-14B	4-19	P	3	4
84HA-3007A, 84HA-3007B, 84HA-3007C	4-7	P	3	2	12K1, 12K1B, 12K2, 12K2B, 12T1, 12T1B, Ch. TS-23B	4-19	P	3	4
					12VF4B, 12VF4R, 12VF4R-C, Ch. TS-23, TS-23A	4-19	P	3	4



## RECEIVING TUBE SUBSTITUTION GUIDE

Model	Rider				Model	Rider			
	Man. Page	Type Cir.	No. of Chains	Sch.		Man. Page	Type Cir.	No. of Chains	Sch.
<u>MOTOROLA INC. (Cont'd)</u>					<u>NORTH AMERICAN PHILLIPS CO., INC. (NORELCO)</u>				
12VF26B, 12VF26B-C, 12VF26R, 12VF26R-C, Ch. TS-23A, TS-23B	4-19	P	3	4	160, Protelgram	3-1	P	1	
12VK11, 12VK11B, 12VK11R, Ch. TS-23, TS-23A, TS-23B	4-19	P	3	4	<u>OLYMPIC RADIO &amp; TELEV. INC.</u>				
12VK15B, 12VK15R, Ch. TS-30, TS-30A	5-8	P	3	4	DX-214, DX-215, DX-216, Serial No. H-200,001 to H-205,000	4-1	P	3	2
12VT13, 12VT13B, 12VT13R, Ch. TS-23, TS-23A, TS-23B	4-19	P	3	4	DX-619, DX-620, DX-621, DX-622, DX-931, DX-932, DX-950	5-1	P	3	2
16K2L, 16K2LB, Ch. TS-52	4-19	P	3	4	TV-104, Cruzair; TV-105, TV-106, Challenger; TV-107, Pacemaker; TV-108, DeLuxe Ten	3-1	P	3	2
16VK1B, 16VK1R, Ch. TS-52	4-19	P	3	4	TV-922	2-1	P	4	6
16VK7B, 16VK7R, Ch. TS-16, TS-16A	4-30	P	3	4	TV-922L, DeLuxe Ten	3-1	P	3	2
19F1, 19F1B, 19K1, Ch. TS-67, TS-67A	5-22	P	3	4	TV-928	2-1	P	4	6
<u>MULTIPLE TELEV. MFG. CO.</u>					TV-944, Beverly; TV-945, Plaza; TV-946, Champion	3-1	P	3	2
M-1500, M-2000	2-1	P	4	5	TV-947, Baronet; TV-949, TV-950	3-11	P	3	2
MR-1500, MR-2000	2-2	P	4	5	XL-210, XL-211, XL-612, XL-613	5-8	P	3	4
MT-1250	2-1	P	4	5	<u>PACKARD-BELL CO.</u>				
<u>MUNTZ T-V, INC.</u>					1091, Ch. 3091; 1080, Radio Ch.	4-1	P	3	5
M-12, Ch. M-158	3-1	P	3	4	2001-TV, 2002-TV	5-1	P	3	4
M-20, M-21, M-22, Ch. M-159-A	3-2	P	3	4	2091-TV, 2092-TV	5-3	P	3	4
M30, Ch. TV16A1; M31, Ch. TV16A2; M31R, M32, Ch. TV16A3	5-1	P	3	4	2291TV, 2292TV, 2293TV, 2294TV, 2295TV, 2296TV	4-10	P	3	4
M-159, Ch.	4-1	P	3	4	2297-TV, DeLuxe, Standard; 2298-TV	4-16	P	3	4
M-159-B, Ch.	3-3	P	3	4	2601-TV, 2692-TV	5-9	P	3	5
M-169, Ch.	3-4	P	3	4	2981, Ch.	4-5	P	3	5
M-169, Ch., Revised	4-2	P	3	4	2991-TV	4-20	P	3	5
<u>NATIONAL CO., INC.</u>					3191TV, 3192TV	4-27	P	3	5
NC-TV-7, NC-TV-7M, NC-TV-7W;	2-1	S-P	2	23	3193TV, 3194TV; 10520, R-F Tuner	3-1	P	3	5
1st Revision	3-1	S-P	2	23	3381TV	3-4	P	3	5
2nd Revision	3-3	P	4	6	4580TV	3-12	P	5	1 & 5
NC-TV-10C	4-1	P	4	6	4691-TV	4-18	P	5	1 & 5
NC-TV-10T	4-1	P	4	6	10527, R-F Tuner	3-23	P	1	
TV-1001, TV-1025	4-1	P	4	6	<u>PATHE TELEVISION CORP.</u>				
TV-1201	5-3	P	4	6	12-2, Ch. 700	5-4	P	2	1
TV-1226, TV-1601, TV-1625	5-3	P	4	6	16-21, 16-22, 16-23, 16-24, 16-25, Ch. 700-1	5-9	P	3	2
<u>NEW ENGLAND TELEV. CO.</u>					<u>PHILCO CORP.</u>				
Custom Console	2-1	P	4	6	48-700	2-1	P	3	2
<u>THE NIELSEN TELEV. CORP.</u>					48-1000, 48-1000-5, Code 125; Code 122	1-1	P	3	4
1018	2-1	P	3	5	Code 121	2-20	P	3	4
1618	4-1	P	3	5		2-37	P	3	4
<u>NORELCO</u>					<u>NORELCO</u>				
See NORTH AMERICAN PHILLIPS CO., INC.					See NORTH AMERICAN PHILLIPS CO., INC.				

## RECEIVING TUBE SUBSTITUTION GUIDE

Model	Rider Man. Page	Type	No. of Chains	Sch.	Model	Rider Man. Page	Type	No. of Chains	Sch.
<u>PHILCO CORP. (Cont'd)</u>					<u>PILOT RADIO CORP. (Cont'd)</u>				
48-1001, Code 121	1-17	P	3	4	TV-37U	2-1	S-P	2	27
48-1001, Code 122	1-17	P	3	4	TV-40, TV-42	2-8	P	5	5
48-2500, Code 122; 48-2500, 48-2500-5	1-23	P	3	4	TV-44 Series, TV-46, TV-47	3-1	P	3	5
49-1002	2-70	P	3	2	TV-120 Series, TV-121	3-10	P	3	2
49-1040, Code 121	3-1	P	3	2	TV-125	5-1	P	3	2
49-1040, Code 123	4-3	P	3	2	TV-161	5-1	P	4	6
49-1075	2-70	S, P	4	12	TV-950, TV-952	2-8	P	5	5
49-1075, 49-1076, Code 122	4-25	S, P	4	12	<u>PLYMOUTH</u> See INTERSTATE STORES BUYING CORP.				
49-1076, Code 123; 49-1077, Code 122	4-3	S, P	4	12	<u>RADIO CORP. OF AMERICA</u> (RCA)				
49-1150, Codes 121A, 121B, 122A, 122B	3-4	P	3	2	S1000, Ch. KCS31-1; RC617B, Radio Ch.	5-48	P	3	2
49-1150, Codes 123A, 123B, 124A, 124B	3-19	P	3	2	T100, Ch. KCS38	5-65	P	3	2
49-1175, Codes 121A, 121B, 122A, 122B	3-4	S, P	4	12	T120, Ch. KCS34C	5-80	P	3	2
49-1175, Codes 123A, 123B, 124A, 124B	3-19	S, P	4	12	T121, Ch. KCS34C	5-95	P	3	2
49-1240	2-70	P	3	2	TRK-5, Ch. KC-3A; RC-429, Radio Ch.	1-1	P	4	5
49-1240, Code 123	4-25	P	3	2	TRK-9, Ch. KC-4A, KC-4C; RC-427A, Radio Ch.	1-14	P	5	5
49-1240, Code 124	4-3	P	3	2	TRK-12, Ch. KC-4, KC-4B; RC-427, Radio Ch.	1-14	P	5	5
49-1275	2-70	S, P	4	12	TRK-90, Ch. KC-4H; RC-427G, Radio Ch.	1-14	P	5	5
49-1278, Code 122	4-25	S, P	4	12	TRK-120, Ch. KC-4F, KC-4J; RC-427F, Radio Ch.	1-14	P	5	5
49-1278, Code 123, 49-1279, Code 122; 49-1280, Code 121	4-3	S, P	4	12	TT-5, Ch. KC-3	1-1	P	4	5
49-1450, Codes 121A, 121B	3-4	P	2	1	8PCS41, 8PCS41-B, 8PCS41-C, Ch. KCS-24B-1, KCS-24C-1	2-1	P	7	2 & 6
49-1450, Codes 123A, 123B	3-19	P	2	1	8T241, 8T243, 8T244, Ch. KCS-28	3-1	P	3	2
49-1450, Codes 123TA, 123TB	3-23	P	2	1	8T270, Ch. KCS-29; 8TC270, 8TG271, Ch. KCS-29A	3-15	P	3	2
49-1475, Codes 121A, 121B	3-4	S, P	4	12	8TK29, Ch. KCS-32A, KCS-32C; RK-135, RK-135A, Radio Ch.	3-29	P	4	3
49-1475, Codes 123A, 123B	3-19	S, P	4	12	8TK320, Ch. KCS33A-1; RK135A-1, Radio Ch.	4-1	P	4	3
49-1475, Codes 123TA, 123TB	3-23	S, P	4	12	8TR29, Ch. KCS-32, KCS-32B; RK-135, RK-135A, Radio Ch.	3-29	P	4	3
49-1480, Codes 121A, 121B	3-4	S, P	4	12	8TS30, Ch. KCS-20J-1, KCS-20K-2	2-11	P	3	5
49-1480, Codes 123A, 123B	3-19	S, P	4	12	8TV41, Ch. KCS-25D-1, KCS-25E-2; RK-117A, Radio Ch.	2-26	P	3	5
49-1480, Codes 123TA, 123TB	3-23	S, P	4	12	8TV321, 8TV323, Ch. KCS-30-1; RC-616B, RC-616C, RC-616J, RC-616K, Radio Ch.	3-43	P	3	2
50-T1104, Code 123	4-27	P	3	4	9PC41, Ch. KCS24C-1, KCS24D	4-16	P	7	2 & 6
50-T1105, 50-T1106	5-1	P	3	4	9T240, Ch. KCS28; 9T240K, Ch. KCS28A	4-26	P	3	2
50-T1400, 50-T1402, 50-T1404	4-27	P	3	4	9T246, Ch. KCS28C, KCS38	4-41	P	3	2
50-T1600, 50-T1632, 50-T1633, Code 121	5-17	P	3	4	9T256, Ch. KCS38C	5-1	P	3	2
<u>PHILHARMONIC RADIO CORP.</u>									
TV-1049, TV-1249	2-1	P	4	6					
<u>PHILMORE MFG. CO., INC.</u>									
P30	2-1	P	3	5					
<u>PILOT RADIO CORP.</u>									
TV-37	2-1	S-P	2	27					

## RECEIVING TUBE SUBSTITUTION GUIDE

Model	Rider Man. Page	Type Cir.	No. of Chains	Sch.	Model	Rider Man. Page	Type Cir.	No. of Chains	Sch.
<u>RADIO CORP. OF AMERICA (Cont'd)</u>					<u>REEVES-SOUNDCRAFT CORP. (VIDEON)</u>				
9T270, Ch. KCS-29, KCS-29C	3-61	P	3	2	AR-100	3-1	P	10	4, 5 & 6
9TC240, Ch. KCS28B	4-26	P	3	2	<u>REGAL ELECTRONICS CORP.</u>				
9TC245, Ch. KCS34B; 9TC247, 9TC249, Ch. KCS34, KCS34B	4-58	P	3	2	CD31, CD36	3-1	P	3	5
9TC272, 9TC275, Ch. KCS-29, KCS-29C	3-61	P	3	2	TV-1030	2-1	P	3	5
9TW309, Ch. KCS41-1; RK135C, Radio Ch. 5-16		P	4	6	TV-1031	2-1	P	3	5
9TW333, Ch. KCS30-1; RC-616N, Radio Ch.	4-73	P	3	2	16T31	3-1	P	3	5
9TW390, Ch. KCS31-1; RC617A, Radio Ch.	5-32	P	3	2	16T36	3-2	P	3	5
621TS, Ch. KCS-21-1	1-44	P	4	6	1007, 1207, 1208	3-4	P	4	3
630TS, Ch. KCS-20A, KCS-20C-2	1-76	P	3	5	1230	3-6	P	3	5
641TV, Ch. KCS-25A-1, KCS-25C-2; RK-117A, Radio Ch.	1-117	P	3	5	1607	3-7	P	4	3
648PTK, Ch. KCS-24-1; RK-121A, Radio Ch.	1-174	P	5	3	<u>REMBRANDT</u> See REMINGTON RADIO CORP.				
648PV, Ch. KCS-24A-1; RK-121A, Radio Ch.	1-174	P	5	3	<u>REMINGTON RADIO CORP. (REMBRANDT)</u>				
721TCS, Ch. KCS-26A-1, KCS-26A-2	1-232	P	3	2	Night Watch, Remington	4-1	P	2	1
721TS, Ch. KCS-26-1, KCS-26-2	1-232	P	3	2	80, 130	1-1	P	5	3
730TV1, Ch. KCS-27-1; RC-610A, Radio Ch.	1-255	P	4	6	721, 1606, 1606-15	4-1	P	2	1
730TV2, Ch. KCS-27-1; RC-610B, Radio Ch.	1-255	P	4	6	1950	2-1	P	2	1
741PCS, Ch. KCS-24B-1	2-47	P	7	2 & 6	1950, Revised	4-1	P	2	1
<u>RADIO CRAFTSMEN, INC.</u>					<u>REPUBLIC TELEVISION INC.</u>				
RC100	4-1	P	2	1	TL-10	1-1	P	3	2
<u>RADIO MERCHANDISE SALES, INC.</u>					<u>SARKES TARZIAN</u>				
SP-2, Antenna Booster	3-1	P	1		TT2	4-1	P	1	
SP-4, Preamplifier	4-1	P	1		TT3	4-3	P	1	
<u>RADIO &amp; TELEVISION INC. (BRUNSWICK)</u>					<u>SCOTT RADIO LABS., INC.</u>				
C-8125, C-8165	4-1	P	3	4	6-T-11	2-1	P	4	6
55B, 55M, 55R, 55W, Ch. 66Z, Canton	2-1	S, P	4	28	13-A	1-1	P	4	5
506-B, Ch. 66Z, Tibet; L-14, Radio	2-1	S, P	4	28	300	3-1	P	4	6
512, 513	4-1	P	3	4	<u>SEARS, ROEBUCK &amp; CO.</u>				
702L; 711, Club; Ch. 66Z	2-1	S, P	4	28	101, Ch. 549.100	5-1	P	3	2
812, 816	4-1	P	3	4	112, Ch. 478.289	5-9	P	4	5
911, 922B, 922M	3-1	P	3	5	125, Ch. 478.257	4-1	P	4	6
5125, 6165	4-1	P	3	4	8132, Ch. 101.854	3-12	P	3	2
<u>RAYTHEON</u> See BELMONT RADIO CORP.					8133, Ch. 101.846; 101.829-1, Radio Ch.	2-1	P	3	2
					9119, 9120, Ch. 101.865	3-23	P	3	2
					9120A, Ch. 101.865-1; 9120B, Ch. 101.865-2	4-37	P	2	1
					9121, Ch. 101.867	4-10	P	2	1
					9122, Ch. 101.864	3-12	P	3	2

## RECEIVING TUBE SUBSTITUTION GUIDE

Model	Rider				Model	Rider			
	Man. Page	Type Cir.	No. of Chains	Sch.		Man. Page	Type Cir.	No. of Chains	Sch.
<u>SEARS, ROEBUCK &amp; CO. (Cont'd)</u>					<u>SKYRIDER</u>				
9122A, Ch. 101.868	4-19	P	2	1	520E	4-1	P	3	2
9123, Ch. 110.499, 110.499A, 110.499B, 110.499-10, 110.499010A, 110.499-10B, 110.499-20, 110.499-10A, 110.499-20B	3-1	P	2	1	521E	4-8	P	3	2
					<u>SONIC INDUSTRIES, INC.</u>				
9124, Ch. 110.499-1, 110.499-1A, 110.499-1B, 110.499-11, 110.499-11A, 110.499-11B, 110.499-21, 110.499-21A, 110.499-21B	3-1	P	2	1	IT4	4-1	P	1	
					<u>SONORA RADIO &amp; TELEV. CORP.</u>				
9125, Ch. 478.252; 9125A, Ch. 478.253	4-1	P	4	6	302, 303, 320	5-1	P	3	2
9125B, Ch. 478.253-1	5-18	P	4	6	700	2-1	P	4	6
9126, Ch. 110.499-2, 110.499-2A, 110.499-2B, 110.499-12, 110.499-12A, 110.499-12B, 110.499-22, 110.499-22A, 110.499-22B	3-1	P	2	1	700A	2-5	P	4	6
					<u>SOVEREIGN TELEVISION CO.</u>				
9128A, Ch. 101.868	4-19,	P	2	1	4920	3-1	P	4	6
9133, 9134, Ch. 101.866; 101.859, Radio Ch.	4-26	P	2	1	<u>SPARTON RADIO-TELEVISION DIV. OF THE SPARKS-WITHINGTON CO.</u>				
					4900TV, Ch. 24TV9C; 9L8, Radio Ch.	3-1	P	3	4
<u>SENTINEL RADIO CORP.</u>					4901TV, Ch. 24TV9C	4-1	P	3	4
1U416	5-1	P	4	6	4916, 4917, 4918, Ch. 24TL10; 6S10, Radio Ch.	4-5	P	3	4
1U419, 1U420	5-9	P	4	6	4920, 4921, 4922, Ch. 24TM10	4-11	P	3	4
400TV	2-1	P	3	2	4935, Ch. 23TC10	5-1	P	3	2
400TV, Revised	3-1	P	3	2	4939TV, Ch. 24TV9; 9L8, Radio Ch.	3-1	P	3	4
401, 402, Series	3-8	P	3	4	4940TV, 4941TV, Ch. 24TV9; 9L8, Radio Ch.	3-1	P	3	4
405TVM	2-1	P	3	2	4942, Ch. 23TC10	5-1	P	3	2
405TVM, Revised	3-1	P	3	2	4944, 4945, Ch. 24TB10	4-12	P	3	4
406 Series	3-8	P	3	4	4951, 4952, Ch. 24TA10	4-1	P	3	4
407, 409	4-1	P	4	3	4954, 4960, Ch. 23TC10	5-1	P	3	2
412, 413, 414, 415	4-10	P	4	6	4964, 4965, Ch. 23TB10	5-15	P	3	4
416	5-1	P	4	6	4970, 4971, 4972, Ch. 24TF10	5-23	P	3	4
419, 420	5-9	P	4	6	5002, 5003, 5006, 5007, Ch. 23TD10	5-1	P	3	2
					<u>STANDARD COIL PRODUCTS CO., INC.</u>				
<u>SHEVERS, INC.</u>					TV-100 Series	2-1	P	1	
Bryant, Classic, Regency, Trafalgar, Ch. 032-16, 032-19	5-1	P	3	5	<u>STARRETT TELEVISION CORP.</u>				
<u>SIGHTMASTER CORP.</u>					M412 Series, Nathan Hale	4-1	P	3	4
E, Series	2-3	P	3	2	3R2-37-9, Lowell, Jackson, Cleveland, King Arthur, John Hancock	4-2	P	3	5
K-50	5-1	P	2	1	3R3-36-9, Adams	4-3	P	3	5
M, Series	2-3	P	3	2	3R3-37-9, Lowell, Jackson, Cleveland, King Arthur, John Hancock	4-2	P	3	5
10-S1, 12-S1, 15-S1	1-1	P	3	2	3V3-429, Lincoln, Gotham, Washington, Cosmopolitan	4-4	P	3	5
10-S1, 12-S1, 15-S1, Late	2-1	P	3	2	6S1-199, Sam Houston, Nathan Hale	5-1	P	4	6
<u>MARK SIMPSON MFG. CO., INC. (MASCO)</u>					501-22-9, Henry Hudson, Henry Parks	4-6	P	3	2
MTB-13X, 1MB-13	2-1	P	1						

## RECEIVING TUBE SUBSTITUTION GUIDE

Model	Rider				Model	Rider			
	Man. Page	Type Cir.	No. of Chains	Sch.		Man. Page	Type Cir.	No. of Chains	Sch.
<b><u>STEWART-WARNER ELECTRIC</u></b>					<b><u>TECH-MASTER PRODUCTS CO. (Cont'd)</u></b>				
<b><u>DIV. OF</u></b>					<b><u>(VIDEOLA)</u></b>				
<b><u>STEWART-WARNER CORP.</u></b>									
AVC1, Code 9054B; AVC2, Code 9054-C AVC3, Code 9054-B; AVT1, Code 9054-A	3-15	S-P	6	30	AGC Kit	4-1	P	1	
T-711, Code 9031-A; T-711M, Code 9031-AM; T-712, Code 9031-B; TRC-721, Code 9037-A	2-1	P	3	2	BC 1223, Blue Ribbon	4-2	P	3	2
9100-A, 9100-B, 9100-C, 9100-D, 9100-E, 9100-F, 9100-G, 9100-H	3-1	S-P	5	29	TVB, Booster Kit	4-6	P	1	
9103-B, 9103-C, 9103-E	4-1	P	2	1	16CK, Conversion Kit	4-8	P	1	
9104-A, 9104-B, 9104-C	4-22	P	2	1	630TK, Same as RCA 630TS	1-76	P	1	
9106-A, 9106-B	5-1	P	2	1	930, 1230	3-1	P	3	5
9108-A, 9108-B	5-15	P	2	1	1530, 1630, 1631, 2031	3-2	P	3	5
<b><u>STOLLE ENGINEERING &amp; MFG. CO.</u></b>					<b><u>TELECOIN CORP.</u></b>				
					<b><u>(TELE-VIDEO)</u></b>				
Magic Lantern	3-1	P	3	4	AR-100, Same as Reeves-Soundcraft AR-100	3-1	P	10	4,5&6
4830-12	3-2	P	3	5	<b><u>TELECRAFT CORP.</u></b>				
					<b><u>TELE-KING CORP.</u></b>				
<b><u>STROMBERG-CARLSON CO.</u></b>									
TC-10, Manhattan	4-1	P	2	1	15-Inch Set, See RCA 8TS30	2-11	P	3	5
TC-19, TC-19 Rev., TC-19-M5M	5-1	P	4	5	210, 310	2-1	P	5	3
TC-125	4-5	P	2	1	410	3-1	P	3	4
TS-15, TS-16, TS-125, Series	3-1	P	4	5	416	5-1	P	3	4
TV-10L, Ch. 112020, Series 10	1-1	P	7	4 & 6	510	4-1	P	3	4
TV-10L, Ch. 112020, Series 11	1-1	P	7	4 & 6	512	3-1	P	3	4
TV-10LW, Ch. 112020, Series 10	1-1	P	7	4 & 6	612, Revised	4-1	P	3	4
TV-10LW, Ch. 112020, Series 11	1-1	P	7	4 & 6	616	5-1	P	3	4
TV-10PM, Ch. 112025, Series 11; 1220, Ch. 112022, Radio	1-1	P	7	4 & 6	710	3-1	P	3	4
TV-10PY, Ch. 112025, Series 11; 1220, Ch. 112022, Radio	1-1	P	7	4 & 6	712	4-1	P	3	4
TV-12H1M, TV-12H2A, TV-12H2M, Ch. 112040; TV-12LM, Ch. 112035; TV-12M5M, TV-12PGM, Ch. 112034; 1220T, Ch. 112031, Radio	1-17	P	3	2	716	5-1	P	3	4
16-CA, 16-CM, 16-RPM, 16-TA, 16-TM	5-8	P	3	2	816	5-1	P	3	4
<b><u>SYLVANIA ELECTRIC PRODUCTS INC.</u></b>					<b><u>TELEKIT</u></b>				
					See ELECTRO-TECHNICAL INDUSTRIES				
1-075, Ch. 1-139	4-1	P	2	1	<b><u>TELE-TONE RADIO CORP.</u></b>				
1-076, Ch. 1-108	5-1	P	2	1	7-Inch AC-DC	2-1	S-P	3	31
1-090, Ch. 1-168	4-16	P	2	1	TV-149	2-2	S-P	3	32
1-113, 1-114, 1-124, 1-125, Ch. 1-139	4-1	P	2	1	TV-208TR	3-1	S-P	3	17
1-128, Ch. 1-108	5-1	P	2	1	TV-249	2-7	P	4	6
1-177, Ch. 1-186	4-14	P	2	1	TV-254TR, Ch. TK	4-1	P	2	1
1-210, Ch. 1-139	4-1	P	2	1	TV-255, TV-256, Ch. TS	4-6	P	3	2
<b><u>TECH-MASTER PRODUCTS CO.</u></b>					<b><u>(VIDEOLA)</u></b>				
					TV-284, Ch. TJ	4-12	P	4	5
					TV-284 up to Serial #C12-127, Ch. TH, TJ	5-2	P	4	5
					TV-286, Ch. TJ	4-12	P	4	5

## RECEIVING TUBE SUBSTITUTION GUIDE

Model	Rider Man. Page	Type Type Cir.	No. of Chains	Sch.	Model	Rider Man. Page	Type Type Cir.	No. of Chains	Sch.
<u>TELE-TONE RADIO CORP. (Cont'd)</u>					<u>TRADIOVISION</u> See <u>TRADIO, INC.</u> Also See <u>TRAD TELEVISION CORP.</u>				
TV-286 up to Serial #C16-263, Ch. TH, TJ	5-2	P	4	5					
TV-287, Ch. TJ	4-12	P	4	5					
TV-287 after Serial #12-100, Ch. TH, TJ	5-2	P	4	5					
TV-288, Ch. TJ	4-12	P	4	5					
220, Ch. TR, Rev.	5-1	S-P	3	17					
<u>TELE-VIDEO</u> See <u>TELECOIN CORP.</u>					<u>TRANSVISION, INC.</u>				
<u>TELEVISION ASSEMBLY CO.</u> SUBSIDIARY OF <u>SNAIDER TELEVISION CORP.</u>					Booster	2-6	P		1
					A-1	2-1	P	2	1
					A-2	2-4	P	2	1
					A-3	2-1	P	2	1
					7-Inch Kit, Early	1-1	P	3	2
					7-Inch Kit, Late	1-1	P	3	2
					12-Inch Kit	1-31	P	3	2
<u>TELEVISION DEVELOPMENT LABS., INC.</u>					<u>TRANS-VUE CORP.</u>				
Champion, Standard	3-1	P	3	5	90X, 90XFM, 90XFMB	4-1	P	4	6
F1-101	1-1	P	3	5	145, 145B	3-1	P	4	6
P-520	2-1	P	6	3	160-L, Entertainer	3-3	S-P	6	33
820A, Televue	1-1	P	3	2	400	5-1	P	2	1
					601, 610, Ch. 16AX23, 16AX25, 16AX26	5-11	P	2	1
<u>TELEVISION EQUIPMENT CORP.</u>					<u>TRAV-LER RADIO CORP.</u>				
S-501, Antenna Multicoupler	3-1	P		1	10T	3-1	P	3	4
<u>TELEVISTA CORP. OF AMERICA</u>					12L50	5-1	P	4	6
Arista, Electra, Empress	4-1	P	4	6	12T	3-1	P	3	4
Monte Carlo	2-1	P	3	5	16G50, 16R50	5-1	P	4	6
Trafton	4-1	P	4	6	16-T	4-1	P	3	4
100, Monte Carlo	2-1	P	3	5	16T, Rev.	5-11	P	3	4
104, Arista, Electra, Empress, Trafton	4-1	P	4	6	16T50	5-1	P	4	6
<u>TELINDUSTRIES, INC.</u> (KAYE-HALBERT)					<u>UNITED MOTORS SERVICE</u> DIV. OF GENERAL MOTORS CORP.				
821, 921, 1621	4-1	P	3	2	TV-71	2-1	S-P	3	25
<u>TEL VISION</u>					TV-71A	2-6	S-P	3	25
TR7-1, Ch. TR10C-1	1-1	P	2	1	TV-101	3-1	P	3	2
TR10-1, Ch. TR10C-1	1-1	P	2	1	TV-102	4-1	P	3	2
<u>TEMPLE</u> See <u>TEMPLETONE RADIO MFG. CORP.</u>					TV-121, TV-122	5-1	P	3	2
<u>TEMPLETONE RADIO MFG. CORP.</u> (TEMPLE)					TV-160	4-9	P	3	2
TV-1776	2-1	P	2	1	TV-201	3-8	P	3	2
<u>TRAD TELEVISION CORP.</u>					<u>U.S. TELEVISION MFG. CORP.</u>				
13, 14	3-1	P	5	3	R-F Tuner, Type A	1-1	P		1
TT-63-SH	5-1	P	3	5	10-Inch Direct View	1-37	P	3	2
					10-Inch Direct View; 15-Inch Direct View	1-39	P	3	2
					C1630, C19031	4-1	P	3	5
					CFM12823-1, CFM15925	3-1	P	3	2
9	1-1	P	5	1&4	CFM16031, CFM19032	4-1	P	3	5

## RECEIVING TUBE SUBSTITUTION GUIDE

Model	Rider				Model	Rider			
	Man. Page	Type Cir.	No. of Chains	Sch.		Man. Page	Type Cir.	No. of Chains	Sch.
<u>U.S. TELEVISION MFG. CORP. (Cont'd)</u>					<u>WESTERN AUTO SUPPLY CO. (Cont'd)</u>				
KRV12823-1, KRV15831-3	3-1	P	3	2	D1993A, D1993B	3-15	P	4	6
T502, T507, T508, T521, T525, T530, T621	1-13	P	4	3	D1994	4-1	P	4	6
T10823	2-1	P	3	2	D1996	4-11	P	3	2
T16030, T19031, TFM16031, TFM19032	4-1	P	3	5	D1997A, D1998A	5-12	P	4	6
<u>VIDAIRE TELEVISION CO.</u>					D1998B	5-12	P	3	2
SC-1 Tuner	4-2	P	1		D2044	5-28	P	2	1
100	3-1	P	3	5	D2047	5-22	P	2	1
100A	3-1	P	3	5	D2050A	5-12	P	4	6
<u>VIDCRAFT TELEVISION CORP.</u>					D2982	4-18	P	3	4
A-101, Add-A-Vision	2-1	P	4	6	D2983	4-11	P	3	2
017, 017B, 017C, 017D	5-1	P	3	4	D2985A, D2985B	3-24	S-P	3	9
024 Series	5-2	P	3	2	D2987	3-1	S-P	6	10
5700R	2-3	P	5	1&5	10AX21, Ch.	5-32	P	2	1
<u>VIDEO CORP. OF AMERICA</u>					10AXF44, Ch. 10AX21	5-32	P	2	1
VS-120	2-1	P	4	6	<u>WESTINGHOUSE ELECTRIC CORP.</u>				
VS-160	4-1	P	4	6	H-181	1-30	P	3	2
1510	2-2	P	3	5	H-196, Ch. V-2130	3-1	P	4	5
<u>VIDEODYNE, INC.</u>					H-216, Ch. V-2146-05DX; H-216A, Ch. V-2146-45DX	5-1	P	4	5
10FM, 10TV, 12FM, 12TV	2-1	P	4	6	H-217, H-217A, Ch. V-2146-1	5-11	P	6	5
<u>VIDEOLA</u> See <u>TECH-MASTER PRODUCTS CO.</u>					H-217, H-217A, Ch. V-2146-11DX; H-217B, Ch. V-2146-35DX	5-11	P	4	5
<u>VIDEON</u> See <u>REEVES-SOUNDCRAFT CORP.</u>					H-223, Ch. V-2150-01	3-19	P	3	5
<u>VIEWTONE TELEVISION &amp; RADIO CORP.</u>					H-226, Ch. V-2146-21DX, V-2146-25DX	5-26	P	4	5
VP100, VP100A, VP101A, Adventurer, Futura	1-1	P	3	2	H-231, Ch. V-2150-51; V-2137-3, V-2137-3S, Radio Ch.	5-35	P	3	5
<u>VISION RESEARCH LABS., INC.</u>					H-242, Ch. V-2150-31	4-1	P	3	5
F-M Teletuner	2-1	P	1		H-251, Ch. V-2150-81, V-2150-82, V-2150-84	4-9	P	3	5
TVA	2-1	P	1		H-600T16, Ch. V-2150-61	4-17	P	3	5
TVX	2-2	P	1		H-601K12, H-602K12, Ch. V-2150-41	4-25	P	3	5
TVZ	2-2	P	1		H-603C12, Ch. V-2152-01	5-46	P	5	5
<u>WARWICK MFG. CORP.</u>					H-604T10, H-604T10A, Ch. V-2150-91A, V-2150-94, V-2150-94A	4-33	P	3	5
167	5-1	P	3	4	H-605T12, Ch. V-2150-101	5-55	P	3	5
<u>WESTERN AUTO SUPPLY CO.</u>					H-608C12, Ch. V-2152-01	5-46	P	5	5
D1090	5-1	P	3	2	WRT-700, WRT-701	1-1	P	4	5
D1092	5-7	P	3	4	WRT-702, WRT-703	1-7	P	5	5
D1990	3-1	S-P	6	10	<u>WILCOX-GAY CORP.</u>				
D1991A, D1991B	3-15	P	4	6	OD Series, Serial Nos. below 26,000	5-1	P	4	6
D1992	3-1	S-P	6	10	OF Series	5-11	P	4	6

## RECEIVING TUBE SUBSTITUTION GUIDE

Model	Rider				Model	Rider			
	Man. Page	Type	No. of Cir.	No. of Chains Sch.		Man. Page	Type	No. of Cir.	No. of Chains Sch.
<b>WILCOX-GAY CORP. (Cont'd)</b>					<b>ZENITH RADIO CORP. (Cont'd)</b>				
OL Series, Serial Nos. Below 26,000	5-22	P	3	2	G2951, G2951R, Stratosphere; G2952R, St. Regis; Ch. 29G20	3-1	P	5	5
9V Series	4-1	P	2	1	G2957, Ch. 23G23, Endue; G2957R, Ch. 23G23, Regent; G3059R, Ch. 24G23, 24G25, Sheraton; G3062, Ch. 24G23, 24G25, Classic; 6G20, Radio Ch.	4-17	S-P	5	35
9W Series	4-12	S,P	2	34					
<b>ZENITH RADIO CORP.</b>									
G2322, Ch. 23G22, Claridge	4-17	S-P	5	35	G3157RZ, Madison; G3157Z, Entwine; G3158RZ, Van Buren; G3173RZ, Madison; G3173Z, Entwine; G3174RZ, Van Buren; Ch. 23G24	4-38	P	3	5
G2322Z, G2327Z, Ch. 23G24, Garfield	4-38	P	3	5					
G2340, Ch. 23G22, Endear; G2340R, Ch. 23G22, Saratoga	4-17	S-P	5	35	G3259RZ, Washington; G3262Z, Jefferson; G3275RZ, Washington; G3276Z, Jefferson; Ch. 24G26	4-38	P	3	5
G2340RZ, Ch. 23G24, Adams; G2340, Ch. 23G24, Ensign	4-38	P	3	5	27T965R, Ch. 27F20, 27F20Z, Broadmoor	3-1	P	5	5
G2346R, Ch. 23G22, Graemere	4-17	S-P	5	35	28T295, Ch. 28F22	2-1	P	5	5
G2350RZ, Ch. 23G24, Adams; G2350Z, Ch. 23G24, Ensign	4-38	P	3	5	28T925E, 28T925EU, Ch. 28F22, Revised, Biltmore; 28T295R, 28T92RU, Ch. 28F22 Revised, Mayflower; 28T926E, Ch. 28F25, Saratoga; 28T926R, Ch. 28F25, Claridge	3-1	P	5	5
G2353E, Ch. 23G22, Biltmore	4-17	S-P	5	35	28T960, Ch. 28F20	2-1	P	5	5
G2353EZ, G2356EZ, Ch. 23G24, Tyler	4-38	P	3	5	28T960E, Ch. 28F20 Revised, 28F20Z, Waldorf; 28T960K, Ch. 28F20 Revised, Derby	3-1	P	5	5
G2420E, Ch. 24G20, Wilshire; G2420-EOX, Ch. 24G20-OX, Wilshire; G2420R, Ch. 24G20, Newport; G2420-ROX, Ch. 24G20-OX, Newport	4-1	P	4	6	28T961, Ch. 28F21	2-1	P	5	5
G2437RZ, Jackson; G2438RZ, Lincoln; G2438Z, Entice; G2439RZ, Monroe; Ch. 24G26	4-38	P	3	5	28T961E, Ch. 28F21 Revised, Wilshire	3-1	P	5	5
G2441, Ch. 24G24, Endow; G2441R, Ch. 24G22, 24G24, Lexington	4-17	S-P	5	35	28T962, Ch. 28F20	2-1	P	5	5
G2441RZ, Lincoln; G2441Z, Entice; Ch. 24G26	4-38	P	3	5	28T962R, Ch. 28F20, Revised, Warwick	3-1	P	5	5
G2442E, Waldorf; G2442R, Mayfair; Ch. 24G22, 24G24	4-17	S-P	5	35	28T963, Ch. 28F21	2-1	P	5	5
G2442RZ, Jackson; G2448RZ, Monroe; Ch. 24G26	4-38	P	3	5	28T963R, Ch. 28F21 Revised, Newport; 28T964R, Ch. 28F23, Stratosphere	3-1	P	5	5
G2454R, Ch. 24G21; G2454-RCX, Ch. 24G21-OX	4-1	P	4	6	29G20, Ch.	3-1	P	5	5
					37T996RLP, Ch. 28F23, Sovereign; 37T998RLP, Ch. 9E21Z, 28F20 Revised, Gotham; 42T999RLP, Ch. 28F23 Marlborough	3-1	P	5	5

### FILAMENT SCHEMATICS

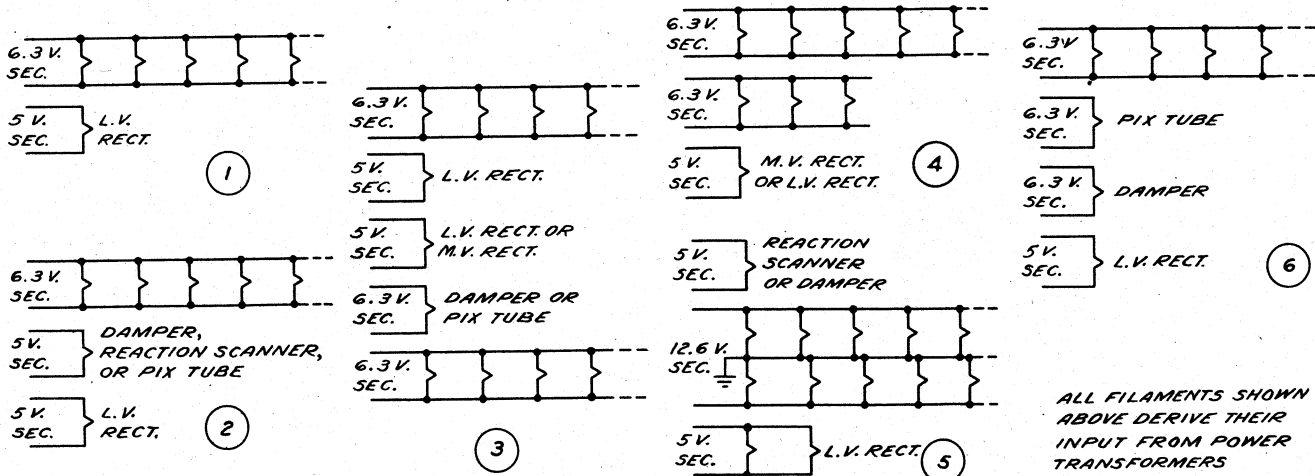

ALL FILAMENTS SHOWN ABOVE DERIVE THEIR INPUT FROM POWER TRANSFORMERS



## RECEIVING TUBE SUBSTITUTION GUIDE

115-125 V. 60 A.C.

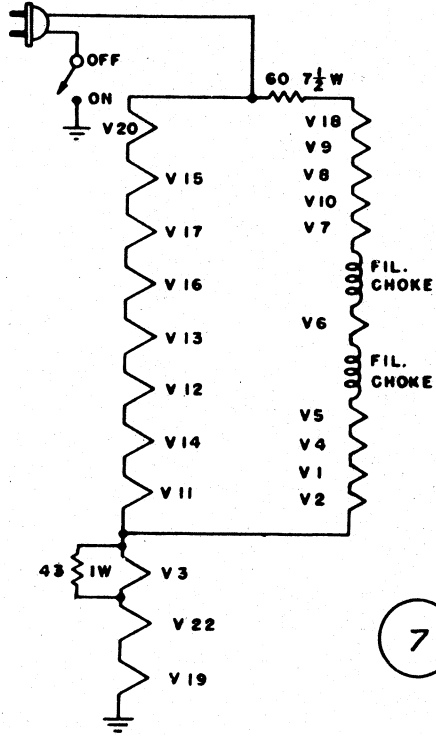

NO	TYPE	FUNCTION	NO	TYPE	FUNCTION
V1	6AU6	RF AMP.	V12	6AT6	AUDIO AMP.
V2	6AG5	MIXER	V13	25L6	AUDIO OUTPUT
V3	6J6	RF OSC.	V14	12SN7	HORIZ. OSC.
V4	6AU6	1ST. IF AMP.	V15	12SN7	HORIZ. OUTPUT
V5	6AU6	2ND. IF AMP.	V16	12SN7	VERT. OSC.
V6	6AU6	3RD. IF AMP.	V17	12SN7	VERT. OUTPUT
V7	6AL5	VIDEO 2ND. DETECTOR	V18	25Z6	L.V. RECTIFIER
V8	6AU6	VIDEO AMP.	V19	6X5	L.V. RECTIFIER
V9	6AU6	VIDEO OUTPUT	V20	12SN7	H.V. OSC.
V10	6AU6	RATIO DETECTOR DRIVER	V22	7JPL	PICTURE TUBE
V11	6AL5	RATIO DETECTOR			

TO 6.3 VOLT SEC. ON FIL. TRANS.

8

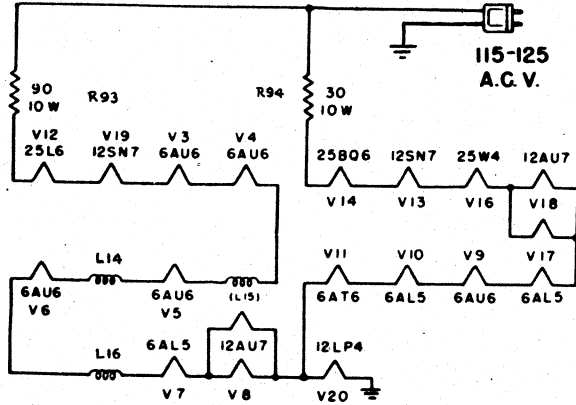
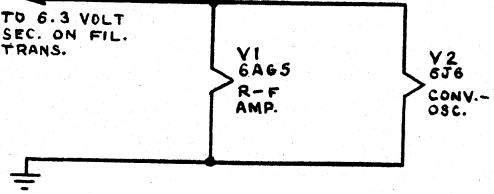

NO	TYPE	FUNCTION	NO	TYPE	FUNCTION
V1	6AG5	RF AMP.	V11	6AT6	AUDIO AMP.
V2	6J6	CONVERTER OSC.	V12	25L6	AUDIO OUT.
V3	6AU6	1ST. IF AMP.	V13	12SN7	HOR. OSC. AND DISCH.
V4	6AU6	2ND. IF AMP.	V14	25B4	HOR. OUT.
V5	6AU6	3RD. IF AMP.	V16	25W4	HOR. DAMP.
V6	6AU6	LTH. IF AMP.	V17	6AL5	HOR. SYNC. DISCR.
V7	6AL5	PIX 2ND DET.		12AU7	SYNC. SEP. AND AMP.
V8	12AU7	1ST. AND 2ND. VIDEO AMP.		12SN7	VERT. OSC. AND OUT.
V9	6AU6	1ST. SOUND IF	V20	12LPL	PICTURE TUBE
V10	6AL5	AUDIO DISCR.			

V2 V1

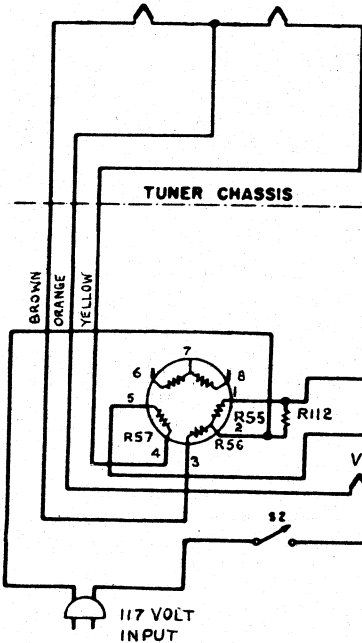

NO	TYPE	FUNCTION
V1	6BW6	RF AMP.
V2	6J6	OSC. CONVERTER
V3	25L6	AUDIO OUT.
V4	19T8	RATIO DET. AND 1ST. AUDIO
V5	12AU6	LIMITER
V6	6BA6	1ST. IF
V7	6BA6	2ND. IF
V8	6BA6	3RD. IF
V9	6AL5	DET. AVC
V10	12AU6	VIDEO AMP.
V11	12AU6	SYNC. SEP.
V12	12SN7	HOR. OSC.
V13	50L6	HOR. OUT.
V14	12SN7	VERT. OSC.
V15	12SN7	VERT. OUT.
V16	50L6	H.V. OSC.
V18	7JPL	PICTURE TUBE

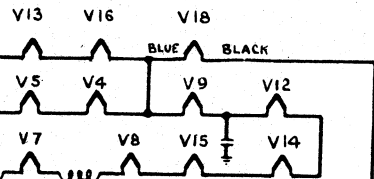





# RECEIVING TUBE SUBSTITUTION GUIDE

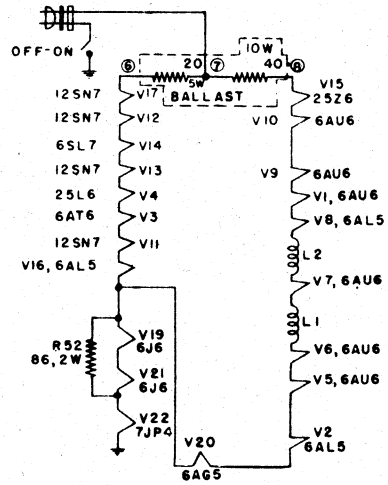
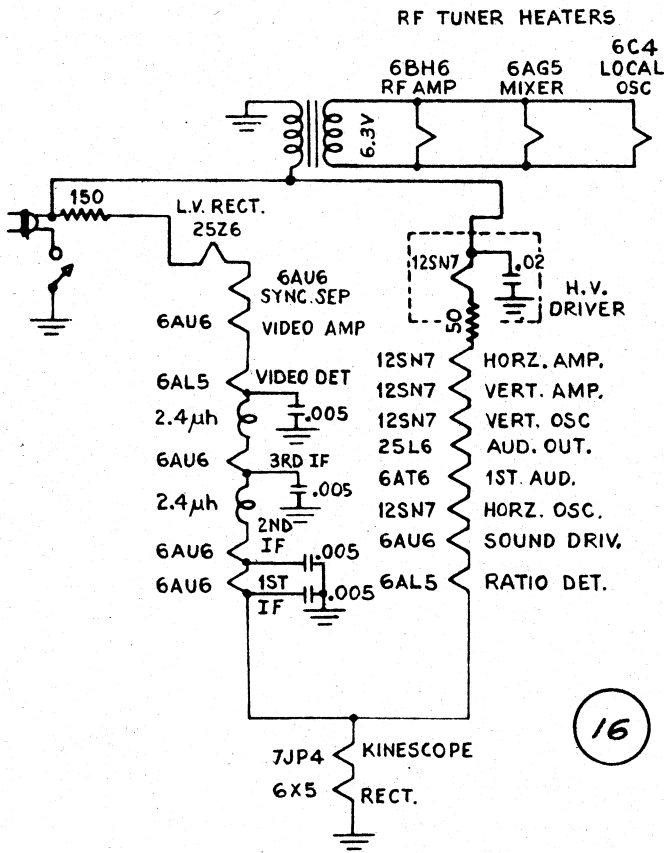

- |                                  |                                |
|----------------------------------|--------------------------------|
| NO FUNCTION                      | NO FUNCTION                    |
| V1 4.5 MC AMPLIFIER              | V12 HORIZ DEFLECTION AMPLIFIER |
| V2 RATIO DETECTOR                | V13 VERTICAL OSCILLATOR        |
| V3 AUDIO AMPLIFIER               | V14 VERT DEFLECTION AMPLIFIER  |
| V4 AUDIO OUTPUT                  | V15 LOW VOLTAGE RECTIFIER      |
| V5 1ST IF AMPLIFIER              | V16 AFC DISCRIMINATOR          |
| V6 2nd IF AMPLIFIER              | V17 HIGH VOLTAGE R F OSC       |
| V7 3rd IF AMPLIFIER              | V18 HIGH VOLTAGE RECTIFIER     |
| V8 VIDEO DETECTOR & AGC          | V19 OSCILLATOR                 |
| V9 VIDEO AMPLIFIER               | V20 CONVERTER                  |
| V10 SYNC SEPARATOR & DC RESTORER | V21 R F AMPLIFIER              |
| V11 HORIZ OSC & AFC AMPLIFIER    | V22 PICTURE TUBE               |

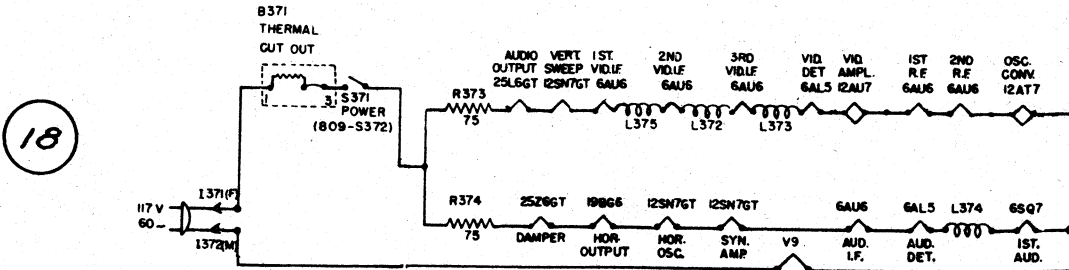

V9 12KD4 PICT. TUBE	V3 12AT7 CONV. OSC.	V2 6AG5 2ND R-F AMP.	V1 6AU6 1ST R-F AMP.	V8 12AT7 1ST 2ND VIDEO AMP.	V23 6AU6 SOUND 1-F AMP.	V6 6AG5 3RD 1-F AMP.	V5 6AG5 2ND 1-F AMP.	V4 6AG5 1ST 1-F AMP.	V10 12SN7GT VERT. SWEEP GEN.	V19 25L6GT AUDIO OUT.
------------------------------	------------------------------	-------------------------------	-------------------------------	---	-------------------------------------	----------------------------------	----------------------------------	----------------------------------	--	--------------------------------

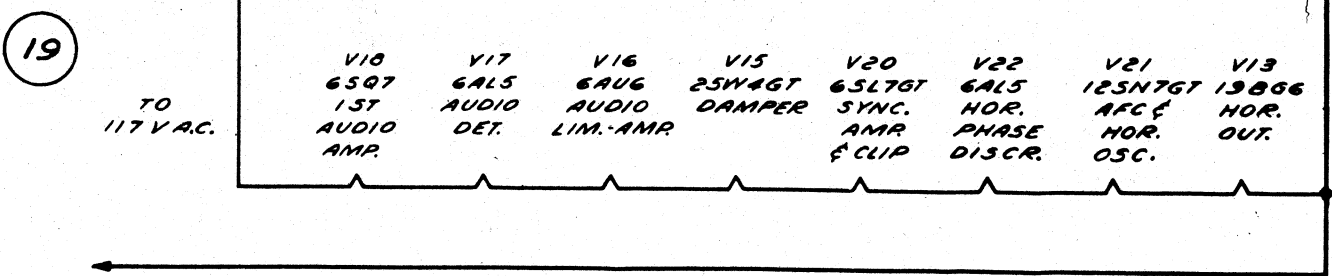

## RECEIVING TUBE SUBSTITUTION GUIDE

V8	V3	V2	V1	V7	V16	V6	V5	V4	V9
12LP4	12AT7	6BC5	6AB4	12AT7	6AU6	6BC5	6BC5	6BC5	12SN7GT
PICT. TUBE	OSC. CONV.	2ND R-F AMP.	1ST R-F AMP.	1ST & 2ND VIDEO AMP.	SOUND I-F AMP.	3RD I-F AMP.	2ND I-F AMP.	1ST I-F AMP.	VERT. SWEEP GEN. & OUT.

20

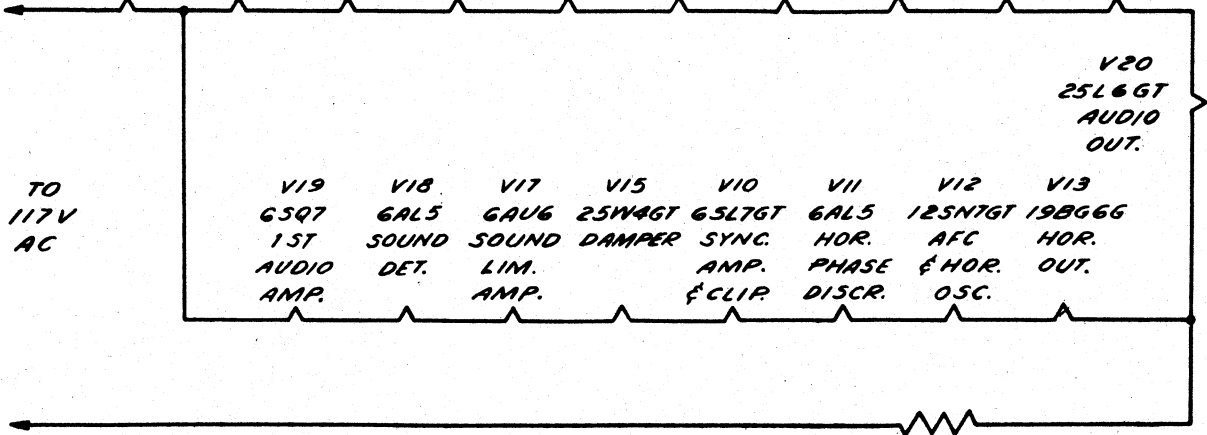

25Z6	12SN7-3	12SN7-1	12SN7-2	6H6	6AL5	6C4	6AG5-2	6AG5-1
RECT.	VERT. OUT.	HOR. OSC.	VERT. OSC.	VIDEO DET.	SOUND DET.	LOCAL OSC.	R.F.	MIX.

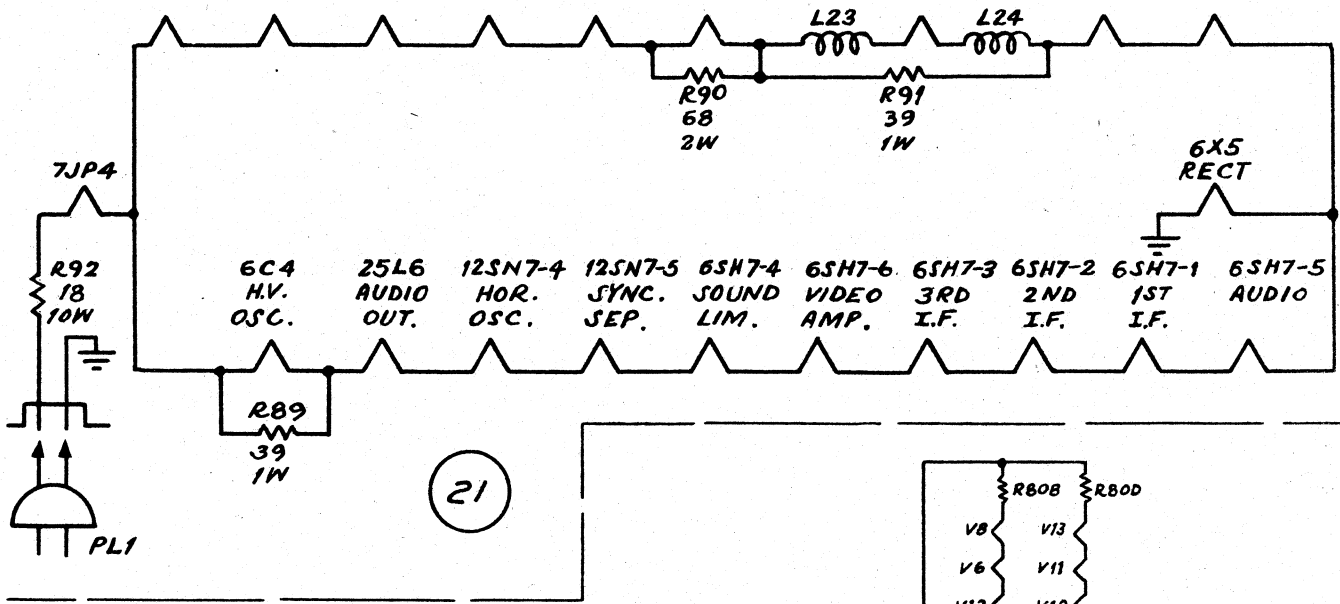

21

NO	TYPE	FUNCTION
V1	6AG5	RF AMP.
V2	6AG5	1ST. IF AMP.
V3	6AG5	2ND. IF AMP.
V4	6AG5	3RD. IF AMP.
V5	6AU6	VIDEO AMP.
V6	6AU6	LIMITER
V7	6S8 GT	RATIO DETECTOR AND AUDIO AMP.
V8	6SL7 GT	VERT. SWEEP OUT.
V9	7F8	RF OSC. AND CONVERTER
V10	12SN7	1ST. CLIPPER AND VERT. SWEEP OSC.
V11	12SN7	2ND. CLIPPER AND HORIZ. SWEEP OSC.
V12	25L6 GT	AUDIO OUT.
V13	25L6 GT	H.V. OSC.
V15	7JP4	PICTURE TUBE

22

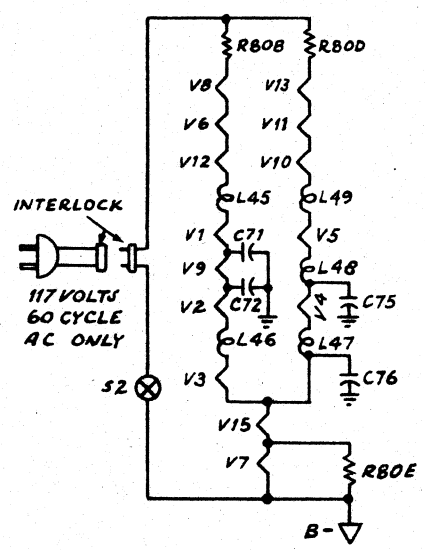

## RECEIVING TUBE SUBSTITUTION GUIDE

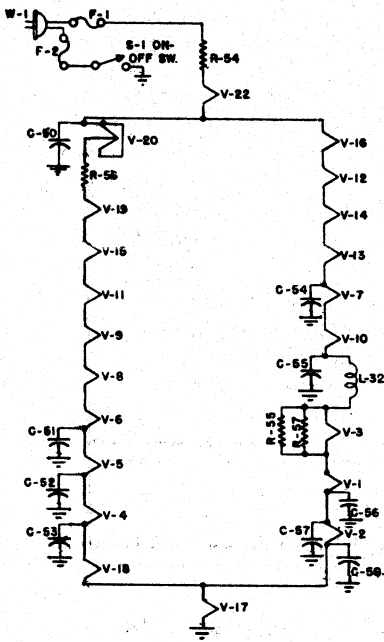

Tube	Function
V1	6AU6 R.F. Amplifier
V2	6AG5 Mixer
V3	6C4 Local Oscillator
V4	6AU6 First Video I.F. Amplifier
V5	6AU6 Second Video I.F. Amplifier
V6	6AU6 Third Video I.F. Amplifier
V7	6AL5 Video Detector—Automatic Gain Control
V8	6AU6 Video Amplifier
V11	6AU6 Sync Clipper—D.C. Restorer
V9	6AU6 4.5 Mc. Ratio Detector Driver
V10	6AL5 Ratio Detector
V18	6AT6 Audio Amplifier
V19	25L6GT/G Audio Output
V13	12SN7GT Vertical Sweep Generator
V12	12SN7GT Vertical Sweep Output
V15	12SN7GT Horizontal Sweep Generator
V14	12SN7GT Horizontal Sweep Output
V20	12AU7 R.F. High Voltage Oscillator
V21	183GT/8016 High Voltage Rectifier
V16	25Z6GT/G Low Voltage Doubler—8 Minus Voltage Rectifier
V17	6X5GT/G Voltage Multiplier
V22	7JP4 Picture Tube

23

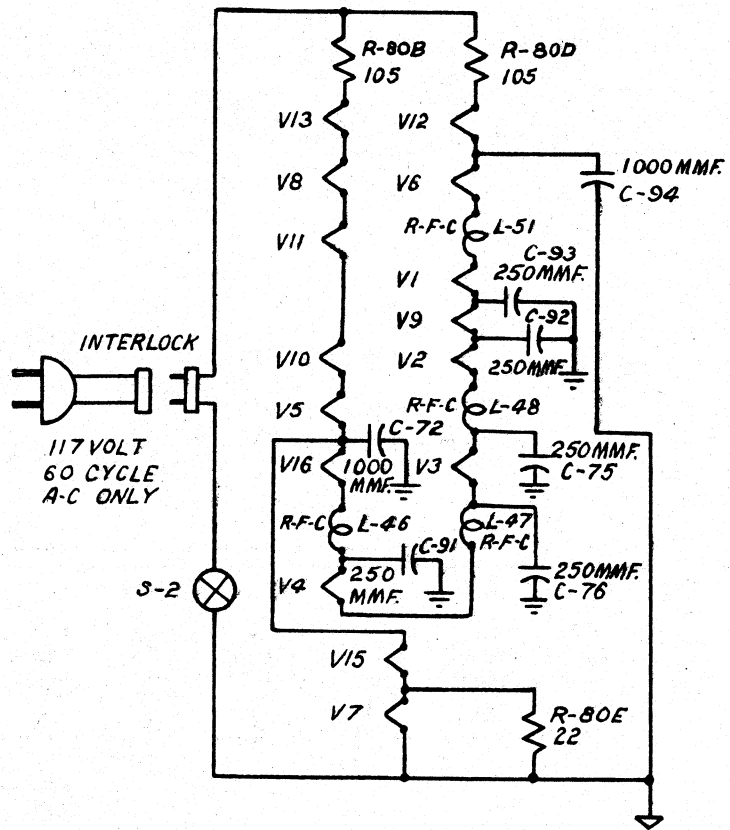

NO	TYPE	FUNCTION
V1	6AG5	RF AMP.
V2	6AG5	1ST. VIDEO IF AMP.
V3	6AO5	2ND. VIDEO IF AMP.
V4	6AG5	3RD. VIDEO IF AMP.
V5	6AU6	VIDEO AMP.
V6	6AU6	LIMITER
V7	6SQ7	AUDIO AMP.
V8	6SL7GT	VERT. SWEEP OUT.
V9	7P8	RF OSC. AND CONVERTER
V10	12SN7GT	1ST. CLIPPER AND VERT. SWEEP OSC.
V11	12SN7GT	2ND. CLIPPER AND HOR. SWEEP OSC.
V12	25L6GT	AUDIO OUT.
V13	25L6GT	H.V. SUP. OSC.
V15	7JP4	PICTURE TUBE
V16	6AL5	RATIO DET.

24

NO	TYPE	FUNCTION
V1	6SH7	AUDIO IF
V2	6AL5	FM-DET.
V3	6SH7	AUDIO AMP.
V4	25L6GT	AUDIO OUTPUT
V5	6AG5	RF AMP.
V6	6AG5	MIXER
V7	6SH7	1ST. IF
V8	6SH7	2ND. IF
V9	6SH7	3RD. IF
V10	6H6	VIDEO DET.
V11	6SH7	VIDEO AMP.
V12	12SN7GT	VIDEO OUT., SYNC. SEP., DC REST.
V13	7JP4	KINESCOPE
V14	6CL	OSCILLATOR
V15	25Z6GT	RECTIFIER
V16	6X5	RECTIFIER
V17	12SN7GT	HORIZONTAL OSCILLATOR
V18	12SN7GT	VERTICAL OSCILLATOR
V19	12SN7GT	HORIZONTAL AMPLIFIER
V20	12SN7GT	VERTICAL AMPLIFIER
V21	6CL	H.V. OSC.

25

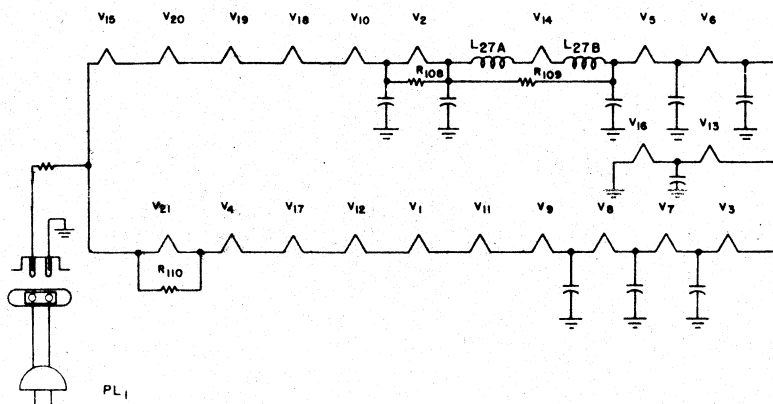

# RECEIVING TUBE SUBSTITUTION GUIDE

26

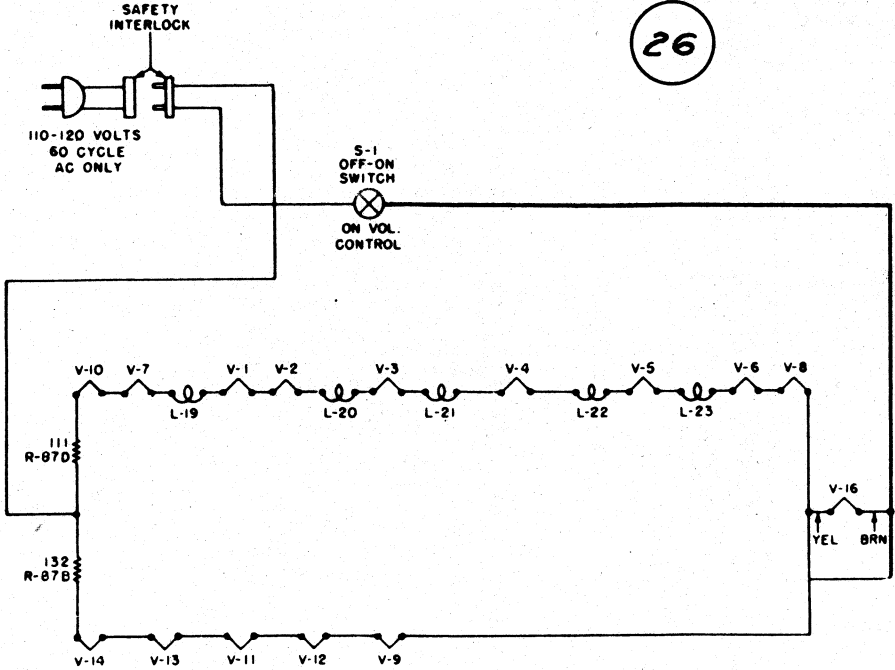

NO	TYPE	FUNCTION
V1	6AG5	RF AMP.
V2	12AT7	MIXER OSC.
V3	6AU6	1ST IF AMP.
V4	6AU6	2ND IF AMP.
V5	6AU6	3RD IF AMP.
V6	6AU6	VIDEO AMP.
V7	6AU6	AUDIO DRIVER-LIMITER
V8	6AL5	RATIO DETECTOR
V9	12SN7	1ST AUDIO AMP., VERT. SWEEP OSC.
V10	25L6	AUDIO OUTPUT
V11	12SN7	1ST & 2ND CLIPPER
V12	12SN7	HORIZ. OSC. & AFC DIODE
V13	6SL7	VERT. SWEEP OUTPUT
V14	25L6	H.V. OSC.
V16	7JF4 8BP4	PICTURE TUBE

27

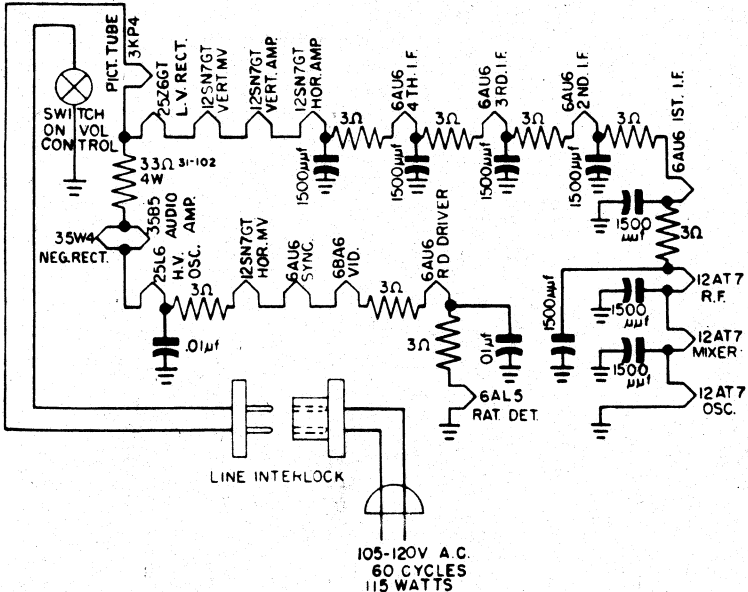

28

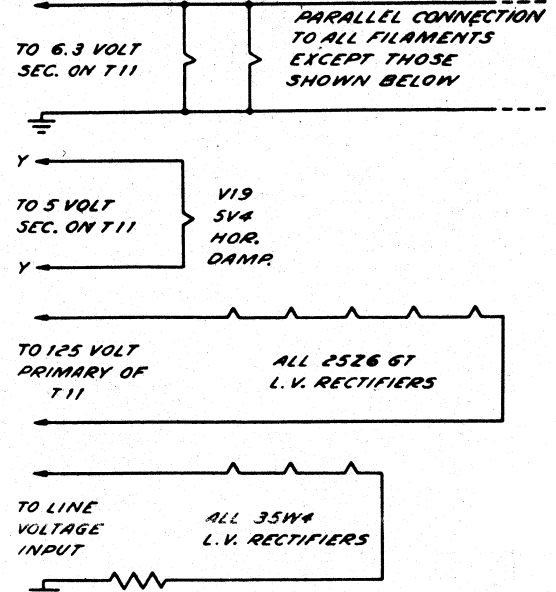

NOTE:  
MODEL 506-B (TIBET) RADIO CHASSIS FILAMENTS ARE IN PARALLEL ARRANGEMENT.

# RECEIVING TUBE SUBSTITUTION GUIDE

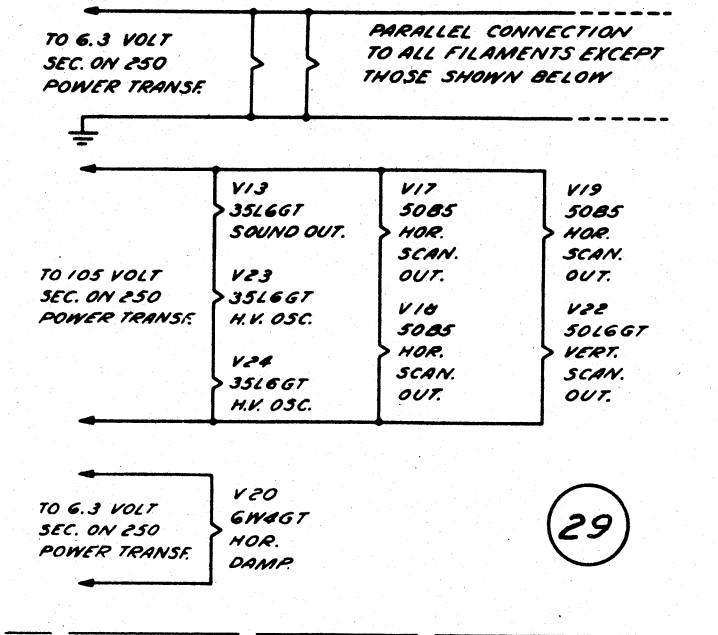

NO	TYPE	FUNCTION
V1	6BH6	RF AMP.
V2	6J6	MIXER-OSC.
V3	12AU6	1ST. IF AMP.
V4	12AU6	2ND. IF AMP.
V5	12AU6	3RD. IF AMP.
V6	12AU6	4TH. IF AMP.
V7	12AL5	DET. AGC
V8	12AU6	VIDEO AMP.
V9	12AU7	DC REST., HOR. SCAN. MVTR.
V10	10BP4	PICTURE TUBE
V11	12AU6	SOUND IF AMP. AND LIM.
V12	19T8	DYN. LIM., SOUND DISCR., SOUND AMP.
V13	50L6GT	SOUND OUT.
V14	12AU6	SYNC. CLIP.
V15	12SN7GT	HOR. SCAN. MVTR. AND AMP.
V16	50B5	HOR. SCAN. OUT.
V17	50B5	HOR. SCAN. OUT.
V18	50B5	HOR. SCAN. OUT.
V19	35Z5GT	HOR. DAMP.
V20	12SN7GT	VERT. SCAN. MVTR.
V21	50L6GT	VERT. SCAN. OUT.
V22	35L6GT	H.V. OSC.
V23	35L6GT	H.V. OSC.
V25	35Z5GT	L.V. RECT.

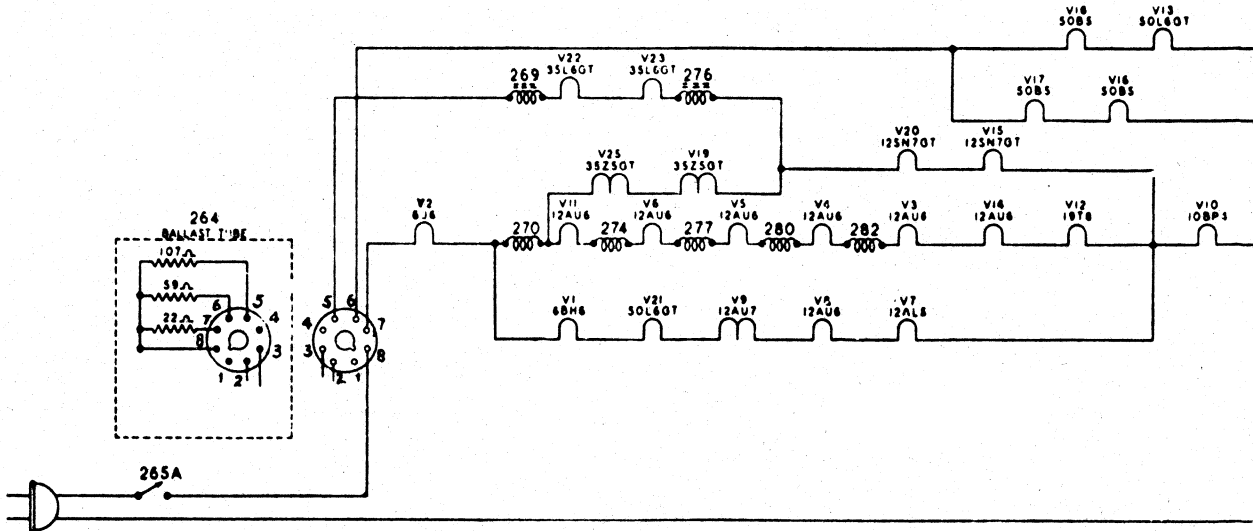

NO	TYPE	FUNCTION
V1	6AU6	AUDIO IF
V2	6AL5	RATIO DET.
V3	6AT6	AUDIO AMP.
V4	25L6	AUDIO OUT.
V5	6AU6	1ST. VIDEO IF
V6	6AU6	2ND. VIDEO IF
V7	6AU6	3RD. VIDEO IF
V8	6AL5	VIDEO DET.
V9	6AU6	VIDEO AMP.
V10	6AU6	SYNC. SEP. AND DC REST.
V11	12SN7	SYNC. AMP. AND HOR. OSC.
V12	6H6	HOR. SYNC. DISCR.
V13	12SN7	HOR. OSC. AND DISCH.
V14	12SN7	HOR. OUT.
V15	12SN7	VERT. OSC.
V16	6SL7	VERT. AMP.
V17	6AU6	RF AMP.
V18	5AG5	CONVERTER
V19	6J6	RF OSC.
V20	25L6	H.V. OSC.
V21	25L6	H.V. OSC.
V23	7JF4	PICTURE TUBE

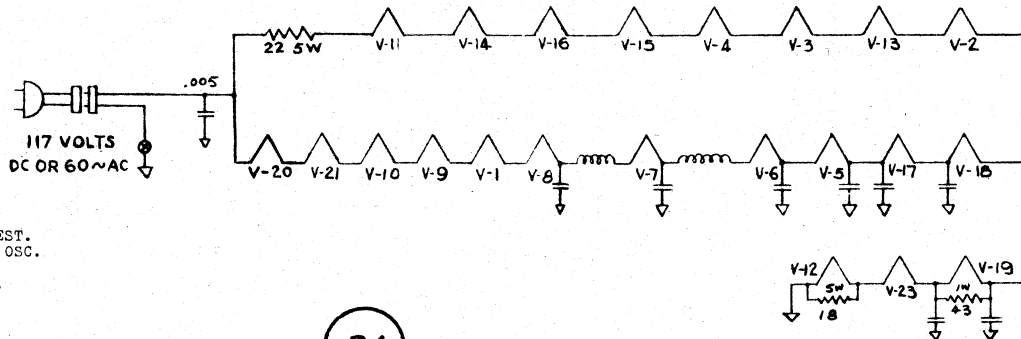



# RECEIVING TUBE SUBSTITUTION GUIDE

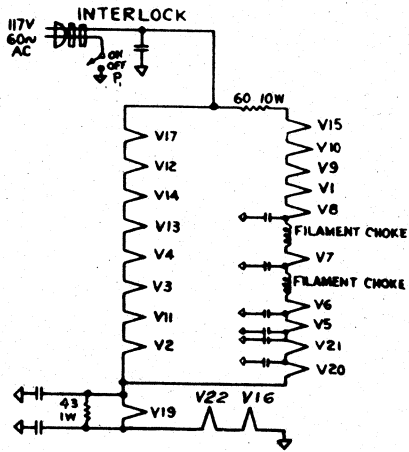

32

NO	TYPE	FUNCTION
V1	6AU6	AUDIO IF
V2	6AL5	RATIO DET.
V3	6AT6	AUDIO AMP.
V4	25L6	AUDIO OUT.
V5	6AU6	1ST. VIDEO IF
V6	6AU6	2ND. VIDEO IF
V7	6AU6	3RD. VIDEO IF
V8	6AL5	VIDEO DET. AND AGC DIODE
V9	6AU6	VIDEO AMP.
V10	6AU6	SYNC. SEP. AND DC REST.
V11	12SN7	HOR. OSC.
V12	12SN7	HOR. AMP.
V13	12SN7	VERT. OSC.
V14	12SN7	VERT. AMP.
V15	25Z6	L.V. RECT.
V16	6X5	VOLTAGE DOUBLER
V17	12SN7	H.V. OSC.
V19	6J6	RF OSC.
V20	6AC5	CONVERTER
V21	6AU6	RF AMP.
V22	7J4	PICTURE TUBE

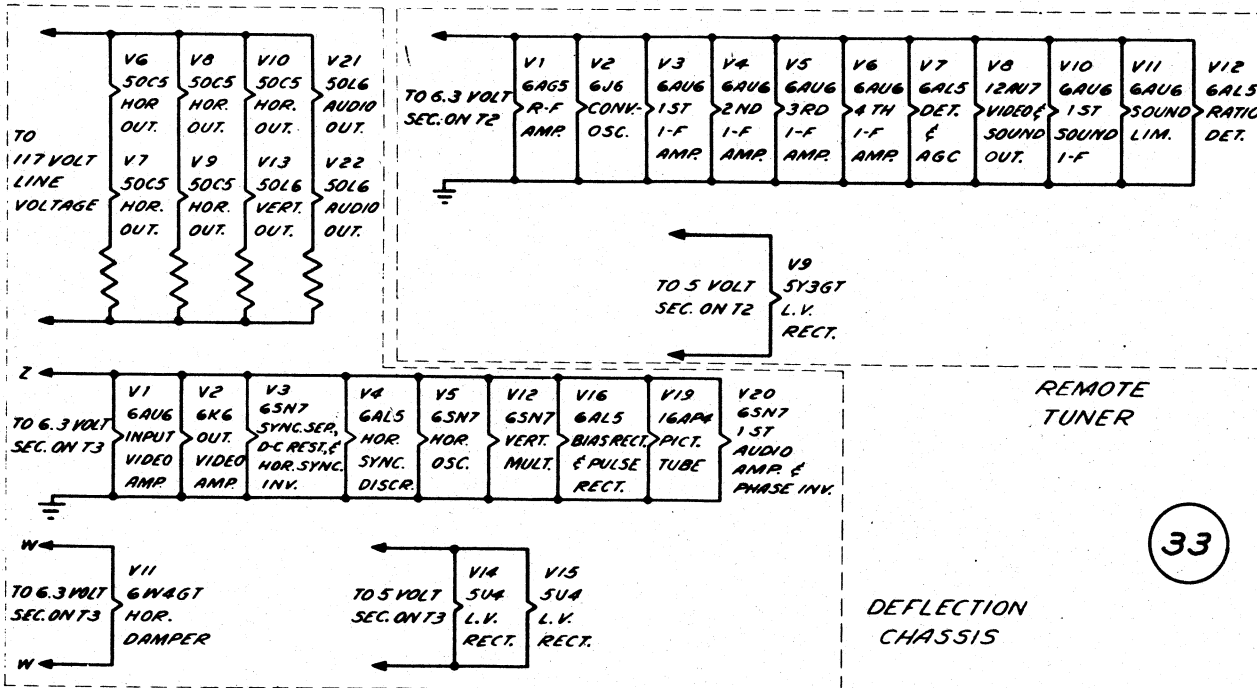

33

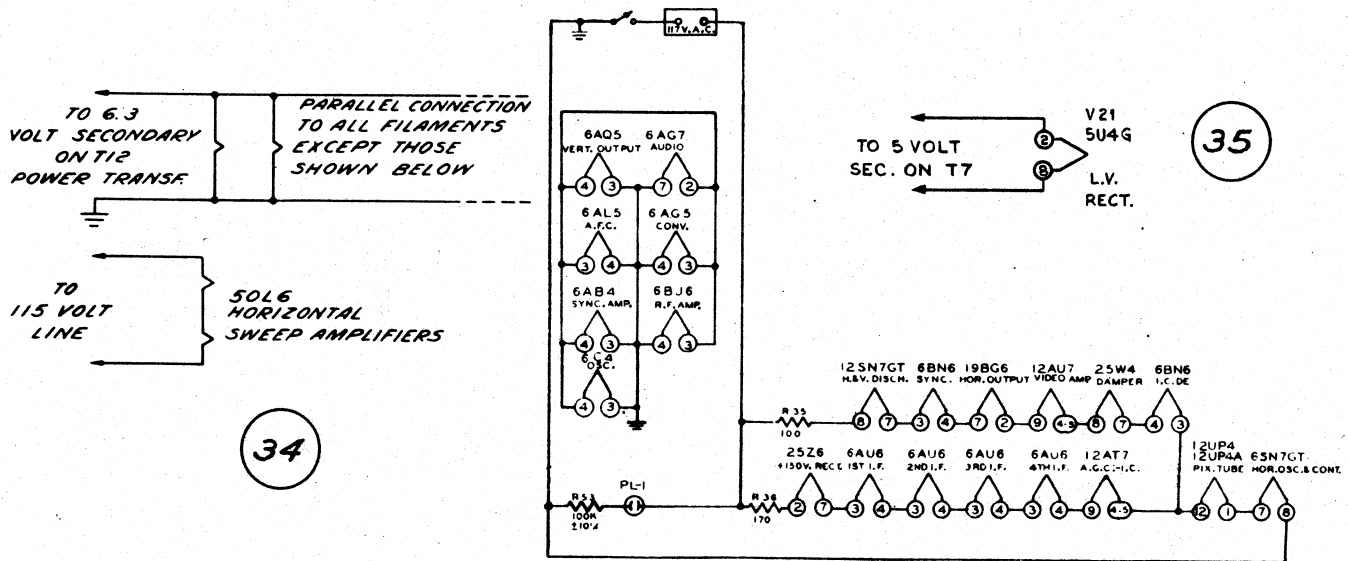

34

35

# SECTION 4

## SERVICING SUGGESTIONS

### Suggestions For Making Adapters

When they are available, the manufacturer's bases and sockets are the thing to use in making adapters but, when this material is not to be had, we have found the following methods very practical.

There is a molded octal socket sold everywhere, which, with the tinned metal mounting removed, fits into the top of a bakelite octal tube base as if made for the purpose. No. 24 or 26 wires are soldered to the socket and pulled down through the tube base pins, soldered and cut off. Bits of spaghetti should be used to avoid shorts. In the case of 12K7 and other tubes with top caps, a hole is drilled in the side of the base opposite the grid pin. A flexible wire with grid clip is brought out through this hole to connect the top cap. In case of substituting a loctal for an octal such as the 1LA6 for 1A7 the grid lead from tube socket is brought out through this hole to connect the top cap.

In case of substituting a loctal for an octal such as the 1LA6 for 1A7, the grid lead from the tube socket is brought out through the side of the base and an old tube cap soldered on. Always select bakelite bases with eight pins. Most octal tubes have only 7 pins or less, but pin 6 is needed in most adapters.

Another, and we believe, better way to make adapters is to remove the 8 pin wafers from the bases of metal tubes. Use No. 18 tinned wire soldering them in the pins first, preferably by dipping, then bend each one so that it will meet the terminal lug on whatever kind of socket is necessary. All of the socket terminal lugs sit down on the bakelite ridge around the wafer and the wires hold them firmly in place.

If 1R5 tubes are comparatively plentiful and 1A7's are impossible to secure, an adapter can be made easily and quickly as follows:

Select an 8 pin octal base with metal band. With the pliers remove the metal, leaving the bottom wafer and pins. Cut 5 pieces of No. 18 tinned wire 1 1/4 inches long, dropping them down into pins 2, 3, 5, 6, and 7, bending them over enough to avoid their falling through and then solder the ends. Put a piece of spaghetti 3/8 inch long on the wire from pin 6 and bend it flat down on the wafer and across to the pin 3, then straight up. Push the wires through holes in miniature socket lugs as shown in substitution data, bend wires outward and down, then cut off close, clinch with pliers and solder. This makes a rugged adapter with very little danger of shorts. The same procedure is followed in making an adapter to use a 1T4 in place of a 1N5. An 8 pin wafer from the base of a metal tube also makes a good adapter.

Adapters are best soldered by dipping. Melt enough solder in a very small pan or tin can lid over an electric or gas hot plate to just touch the ends of the pins on an octal

base when the guide pin is on the bottom. Use a quarter-inch dowel pin or piece of shaft, pushing it down inside the guide pin so that it can be used as a handle. Dip the pins for 3 or 4 seconds then lift it out and dip the ends of the pins in water to cool them quickly. This is very much faster and better than doing it one pin at a time with a soldering iron.

### To Repair the Filaments in 150 Ma Tubes (For Emergency Use Only)

Many 150-ma heater tubes can be made to give additional service after they have been burned out, that is, after the filament is open. The necessary parts are: a power transformer with a 50-ma secondary that will deliver 750 volts across the high-voltage winding, seven octal sockets, two loctal sockets, and a chassis pan with room enough to mount them. The connections are very simple, as illustrated in the diagram of Fig. 4-1, and require less than two hours to assemble.

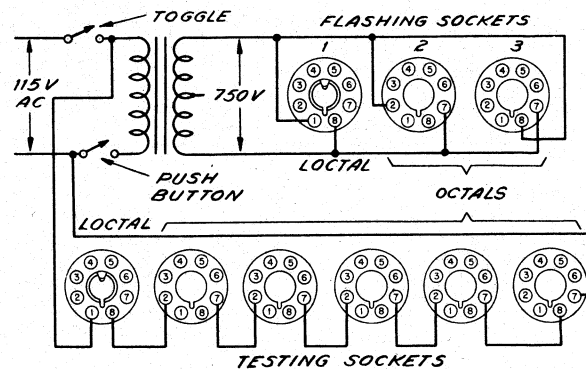

NOTE  
BOTTOM VIEW OF SOCKETS ARE SHOWN

FIG. 4-1. Illustrating the setup for filament repair.

We have found by experience that putting the push button in the primary side of the transformer, in addition to protecting the operator from shocks, causes a hotter starting arc to weld the broken filament. The six sockets connected in series are for testing the repaired tubes. Put enough tubes in series to make as close as possible to 115 volts and short the filament connections on the remaining sockets that are left empty. Number 3 octal socket is for a 12SQ7, 6SQ7, and a few other types which have their heater connections on pins 7 and 8.

The operation is as follows. Insert the line plug, turn on the switch, and place the tube to be repaired in the proper socket. A low-wattage lamp drawing current from the same electric circuit should be in front of the operator. Press the button quickly, making as short a contact as possible. If the lamp dims, you have welded the ends of the

## RECEIVING TUBE SUBSTITUTION GUIDE

heater together. If they are not welded, press the button several more times, while snapping at the tube with the fingers of the other hand. If this does not weld the filaments, allow three seconds to elapse when working with metal tubes and then push the button again. Repeat this, then wait ten seconds and press for the last time. The switch contact should be as short as possible each time.

For 6- and 12-volt glass tubes, the same procedure is employed except that you must observe the tube and continue to press the button at intervals until the filament shows light. For higher voltage tubes such as 50L6, 35L6, 35A5, etc. the button must be held down slightly longer. Success has been obtained in repairing about forty percent of burned out 150-ma heater tubes which include 12SA7, 12SK7, 12SQ7, 50L6, 35Z5, and almost all other 12-, 14-, 35-, and 50-volt heater tubes. The filaments of tubes having current ratings of less than 150 ma will be completely destroyed when burned in this apparatus, and tubes with high current ratings will overload the transformer severely, although in some cases a repair can be made. If the results are not satisfactory, try using a different transformer. Our experience shows, however, that a 750-volt secondary is the most satisfactory.

We have had many inquiries about the low-wattage lamp mentioned above. This lamp should be not larger than 40 watts and does not have to be connected to the apparatus. It may be the light in the shop where you are working and serves only to show you when the current has welded the ends of the broken filament in a metal tube. When the high voltage passes through the filament, there is a surge of current lasting only a very small fraction of a second. The transformer draws a rather large amount of current from the electric light line, pulling the voltage down and causing the light to blink or flicker. It is not needed in the case of glass tubes since you are able to see when the filament lights.

The average life of repaired tubes is short. We describe this process for use only in case of emergency and in no case recommend the use of a repaired tube when a new one is available. Even when the tube is not available, a repaired tube should be burned for at least one hour before putting it in a customer's radio.

### 35Z5 Tubes

Possibly most service men know this, but it will bear repeating for the benefit of those who do not. The 35Z5 filament is between pins 2 and 7 with a tap brought out to pin 3. This tap is about 5 volts, from pins 2 to 3 and provides current for the pilot light. Operating the radio with burned out pilot light causes this section to burn out and breaks the filament circuit. Pins 2 and 3 may be shorted together so as to use the remaining 30-volt filament and the tube may still give long service. Check every burned out 35Z5, and if there is continuity between pins 3 and 7, the tube is still usable.

If it is necessary to use the pilot light, connect a 25- to 30-ohm resistor from pins 3 to 2, either on the tube base (be careful that it does not short to metal chassis) or on the socket terminals, and the pilot light will light as usual.

### Substitution of Complete Sets of Tubes

Most of the popular 12-, 35-, and 50-volt tubes now in use are nearing the end of their lives. Often a customer comes in and pays for a substitute tube and the necessary rewiring job, only to be back again within a week or ten days with another "impossible to get" tube burned out. He may again go to considerable expense to replace that one and have the same thing happen again.

Since most of the 6- and 25-volt, 0.3-ampere tubes are comparatively plentiful, a complete changeover job is more practical and satisfactory. Replace 12SA7 with 6SA7, 12SK7 with 6SK7, 12SQ7 with 6SQ7, 50L6 or 35L6 or any of the other 25-volt, 0.3-ampere output tubes, and 25Z5 with 25Z6. The only necessary changes are in connection with the rectifier tube and replacement of the a-c line cord with a line resistor cord of 130 ohms. Red goes to the switch and black to pins 3 and 5 of the 35Z5 socket after removing the pilot light wire from pin 3. Any wire on pin 4 is removed and taped up, 4 is connected to 8, the line cord resistor and a 25-ohm resistor are connected to the wire from pin 3 and the other end of resistor to pin 2.

### Changing Battery-Operated Radios For Electric Operation

This is not a job for the novice, but any experienced radio serviceman can make the change with very satisfactory results if there is room on the chassis for an additional tube.

First find a location for the rectifier tube, drill a hole and mount the socket. Remove all battery wires. Connect one side of the line cord to pins 2, 3, and 5 of a 117Z6 socket; connect the other side of the cord to the A battery switch, ground the other side of the switch and also pin 7 of the 117Z6.

From pins 4 and 8, the cathodes of the rectifier, connect a 1-w, 1,500-ohm resistor, R1, to the screen grid of the 3Q5 tube or whatever output tube is used. This is the filter resistor and must have a 20-mf, 150-volt capacitor, C1, from each end of the resistor to ground for 60-cycle operation, or 40 mf for 25-cycle operation.

It is quite likely that you will find one end of each tube filament connected to ground. All of these grounds must be removed and the filaments connected in series as shown in Fig. 4-2. The tubes indicated are for a typical battery-operated receiver. The capacitors and resistors connected to pins 2 and 7 may be left where they are, at least for the present. (We are using pin numbers of octal tubes. If the loctal series is used, the filament pins are usually 1 and 8 instead of 2 and 7. The loctal 1LA6 or 1LC6 is the equivalent of the octal 1A7, the loctal 1LN5 or 1LH4 for the octal 1H5, and the loctal 1LA4 or 1LB4 for the octal 1A5 or 1T5.) If there are more tubes than are shown in the diagram, connect their filaments between the 1N5 and the 1H5.

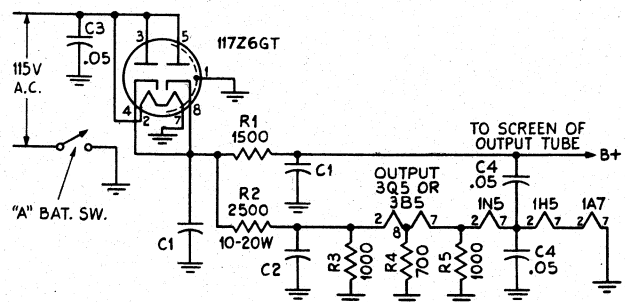

FIG. 4-2. Typical circuit arrangement for changing battery-operated radio to electric operation using a 117Z6GT rectifier tube.

Connect a 2,500-ohm resistor between the rectifier cathodes and one side of the filament of the output tube. This is the filament dropping resistor and has a filter capacitor of from 40 to 200 mf connected between its low

## RECEIVING TUBE SUBSTITUTION GUIDE

end and ground. This capacitor should be rated at 25 volts because if a tube burns out the voltage rises and might break down a 6- or 12-volt rated capacitor. The filament dropping resistor should be 10 watts if mounted above the chassis and at least 20 watts if mounted underneath where it cannot radiate the heat so readily. There is a 2,200-ohm, 16-w flexible resistor, that seems to be quite plentiful, rather low priced, and is very easy to mount since it is insulated.

Wire in the resistors R4 and R5 permanently, and R3 temporarily as it may have to be changed. If a 1A5 or 1T5 is used instead of the 3Q5 or 3B5, resistor R4 is omitted. The purpose of R4 and R5 is to bypass the current passed from plate to filament in the output tube and to avoid overloading the other filaments.

Now check the grid resistors. The resistor from the grid of the output tube should go directly to ground and each of the others to its own negative filament, pin 7. The lower end of the volume control is connected either directly or through a resistor to ground, or to a filament (which has been disconnected from ground). Leave it where it is for trial; however, if there is distortion, try returning it to the filament circuit between the 1A7 and 1H5 for 1.4-volt bias, or between the 1H5 and 1N5 for 2.8-volt bias, leaving it wherever the tone is best.

Now make up a resistor to take the place of a set of tubes. The resistance of each 1.4-volt filament is approximately 28 ohms, and for the set shown in Fig. 4-2 should be a total of 140 ohms. If it had a 1A5 or 1T5 in the output, the resistance would be 28 ohms less, or 112 ohms. If there should be an additional 1.4-volt tube, it would be 28 ohms more, or 168 ohms. Connect this resistor from pin 2 of the output tube to ground. Put in the rectifier tube, connect the line cord of the set and then turn it on. The voltage across the resistor should be slightly less than 7

volts. If over 7 volts, replace resistor R3 with a lower value. If under 6.2 volts, replace R3 with a higher value. If you have difficulty in getting the correct filament voltage, remember that increasing the capacitance of C1 at the rectifier increases the voltage, and if this capacitor does not have sufficient capacitance you cannot get the correct voltage.

When the voltage has been adjusted, remove resistor R3 and then insert the tubes. The bypass capacitor C4 may already be in the set. If the capacitors are not in and there is a tendency to distort or oscillate, put them in, and make sure that all No. 1 pins of the tubes are grounded to chassis. If the radio does not have a series capacitor in the antenna, it is necessary to put in a 0.01 mf between the antenna and coil to avoid burning out the coil if the antenna should be grounded.

Many other types of rectifiers may be used instead of the 117Z6 which was chosen as the example because it does not require a resistor line cord. For 25Z6, use a line-cord resistor of 300 ohms, connecting red to switch, black to pins 3 and 5, and resistor to pin 2; for 35Z5 and 35Z4 tubes, use a 540-ohm resistor cord, connecting black to pin 5, red to switch, and resistor to pin 2; for a 25Z5 tube, use a 300-ohm cord, connecting red to switch, black to pins 2 and 5, resistor to pin 1, pin 6 to ground, and the filter resistor to pins 3 and 4. These are the most popular rectifiers, but several others may be used with the proper line-cord resistor.

The grounding system and physical factors of the receiver to be worked on should be examined before attempting the changeover. Some bugs may be expected on the first job so do not be discouraged if it does not work perfectly right at first; a little patience in trying to get rid of the bugs will be well rewarded. Remember that the filaments of tubes in most battery-operated radios are only d-c operated. Always check the filament conditions of the tubes with which you are working.

# SECTION 5

## CHARTS AND TABLES

In this section a number of charts and tables are shown that we believe will be very helpful to users of this book. Included in this grouping is a complete listing of receiving tube characteristics and bases and also a separate listing of cathode-ray-tube characteristics and bases. In addition such tabulated matter as RTMA capacitor, resistor, and transformer color codes, ballast tube and resistor number-

ing codes, pilot lamps, and a cross index of Army VT numbers and commercial vacuum-tube numbers are included. The last named chart will not only help Armed Forces personnel but will be of valuable aid to anyone who has surplus Army tubes and desires to identify the equivalent commercial number for possible use or substitution in commercial equipment.

### RTMA RECEIVING TUBE RATINGS

It shall be standard to interpret the ratings on receiving types of tubes according to the following conditions:

#### 1. CATHODE

The heater or filament voltage is given as a normal value unless otherwise stated. This means that transformers or resistances in the heater or filament circuit should be designed to operate the heater or filament at rated value for full-load operating conditions under average supply-voltage conditions. A reasonable amount of leeway is incorporated in the cathode design so that moderate fluctuations of heater or filament voltage downward will not cause marked falling off in response; also, moderate voltage fluctuations upward will not reduce the life of the cathode to an unsatisfactory degree.

##### A. 1.4-VOLT BATTERY TUBE TYPES

The filament power supply may be obtained from dry-cell batteries, from storage batteries, or from a power line. With dry-cell battery supply, the filament may be connected either directly across a battery rated at a terminal potential of 1.5 volts, or in series with the filaments of similar tubes across a power supply consisting of dry cells in series. In either case, the voltage across each 1.4-volt section of filament should not exceed 1.6 volts. With power-line or storage-battery supply, the filament may be operated in series with the filaments of similar tubes.

For such operation, design adjustments should be made so that with tubes of rated characteristics, operating with all electrode voltages applied and on a normal line voltage of 117 volts or on a normal storage-battery

voltage of 2.0 volts per cell (without a charger) or 2.2 volts per cell (with a charger), the voltage drop across each 1.4-volt section of filament will be maintained within a range of 1.25 to 1.4 volts with a nominal center of 1.3 volts. In order to meet the recommended conditions for operating filaments in series from dry-battery, storage-battery, or power-line sources it may be necessary to use shunting resistors across the individual 1.4-volt sections of filament.

##### B. 2.0-VOLT BATTERY TUBE TYPES

The 2.0-volt line of tubes is designed to be operated with 2.0 volts across the filament. In all cases the operating voltage range should be maintained within the limits of 1.8 volts to 2.2 volts.

#### 2. POSITIVE POTENTIAL ELECTRODES

The power sources for the operation of radio equipment are subject to variations in their terminal potential. Consequently, the maximum rating shown on the RTMA Vacuum Tube Data Sheets have been established for certain design center voltages which experience has shown to be representative. The design center voltages to be used for the various power supplies together with other rating considerations are as given below:

##### A. A-C OR D-C POWER-LINE SERVICE IN U.S.A.

The design center voltage for this type of power supply is 117 volts. The maximum ratings of plate voltages, screen-supply voltages, dissipation, and rectifier output currents are design maximums and should not be exceeded in equipment operated at a line voltage of 117 volts.

## RECEIVING TUBE SUBSTITUTION GUIDE

### B. STORAGE-BATTERY SERVICE

When storage-battery equipment is operated without a charger, it should be designed so that the published RTMA maximum values of plate voltages, screen-supply voltages, dissipations, and rectifier output currents are never exceeded for a terminal potential at the battery source of 2.0 volts per cell. When storage-battery equipment is operated with a charger, it should be designed so that 90% of the same RTMA values are never exceeded for a terminal potential at the battery source of 2.2 volts.

### C. "B"-BATTERY SERVICE

The design center voltage "B" batteries is the normal voltage rating of the battery block, such as 45 volts, 90 volts, etc. Equipment should be designed so that under no condition of battery voltage will the plate voltages or dissipations ever exceed the recommended respected maximum values shown in the data for each tube type by more than 10%.

### D. OTHER CONSIDERATIONS

#### 1) Class A Amplifiers

The maximum plate dissipation occurs at the "zero-signal" condition. The maximum screen dissipation usually occurs at the condition where the peak-input signal voltage is equal to the bias voltage.

#### 2) Class B Amplifiers

The maximum plate dissipation theoretically occurs

at approximately 63% of the "maximum-signal" condition, but may occur practically at any signal voltage value.

#### 3) Converters

The maximum plate dissipation occurs at the "zero-signal" condition and the frequency at which the oscillator-developed bias is a minimum. The screen dissipation for any reasonable variation in signal voltage must never exceed the rated value by more than 10%.

#### 4) Screen Ratings

When the screen voltage is supplied through a series voltage-dropping resistor, the maximum screen voltage rating may be exceeded, provided the maximum screen dissipation rating is not exceeded at any signal condition, and the maximum screen voltage rating is not exceeded, at the maximum-signal condition. Provided these conditions are fulfilled, the screen-supply voltage may be as high as, but not above, the maximum plate voltage rating.

### 3. TYPICAL OPERATION

For many receiving tubes, the data show typical operating conditions in particular services. These typical operating values are given to show concisely some guiding information for the use of each type. They are not to be considered as ratings, because the tube can be used under any suitable conditions within its rating limitations.

# RECEIVING TUBE SUBSTITUTION GUIDE

## RECEIVING TUBE BASES

The diagrams on the following pages show standard socket connections corresponding to the base designations given in the column headed "Socket Connections" in the classified tube-data tables. Bottom views are shown throughout. Terminal designations are as follows:

- |                      |                          |                      |                            |                             |
|----------------------|--------------------------|----------------------|----------------------------|-----------------------------|
| A = Anode            | F = Filament             | IS = Internal Shield | PBF = Beam-Forming Plates  | S = repeller                |
| B = Beam             | G = Grid                 | K = Cathode          | S = Shell                  | TA = Target                 |
| BP = Bayonet Pin     | H = Heater               | NC = No Connection   | RC = Ray-Control Electrode | ● = Gas-Type Tube           |
| BS = Base sleeve     | IC = Internal Connection | P = Plate (Anode)    | P1 = Starter-Anode         | Ref = Reflector or U = Unit |
| D = Deflecting Plate |                          |                      |                            |                             |

Alphabetical subscripts D, P, T and HX indicate, respectively, diode unit, pentode unit, triode unit or hexode unit in multi unit types. Subscript M, T or CT indicates filament or heater tap.

Generally when the No. 1 pin of a metal-type tube in Table I, with the exception of all triodes, is shown connected to the shell, the No. 1 pin in the glass (G or GT) equivalent is connected to an internal shield.

### R.M.A. TUBE BASE DIAGRAMS

Bottom views are shown. Terminal designations on sockets are shown above. <sup>1B3</sup>

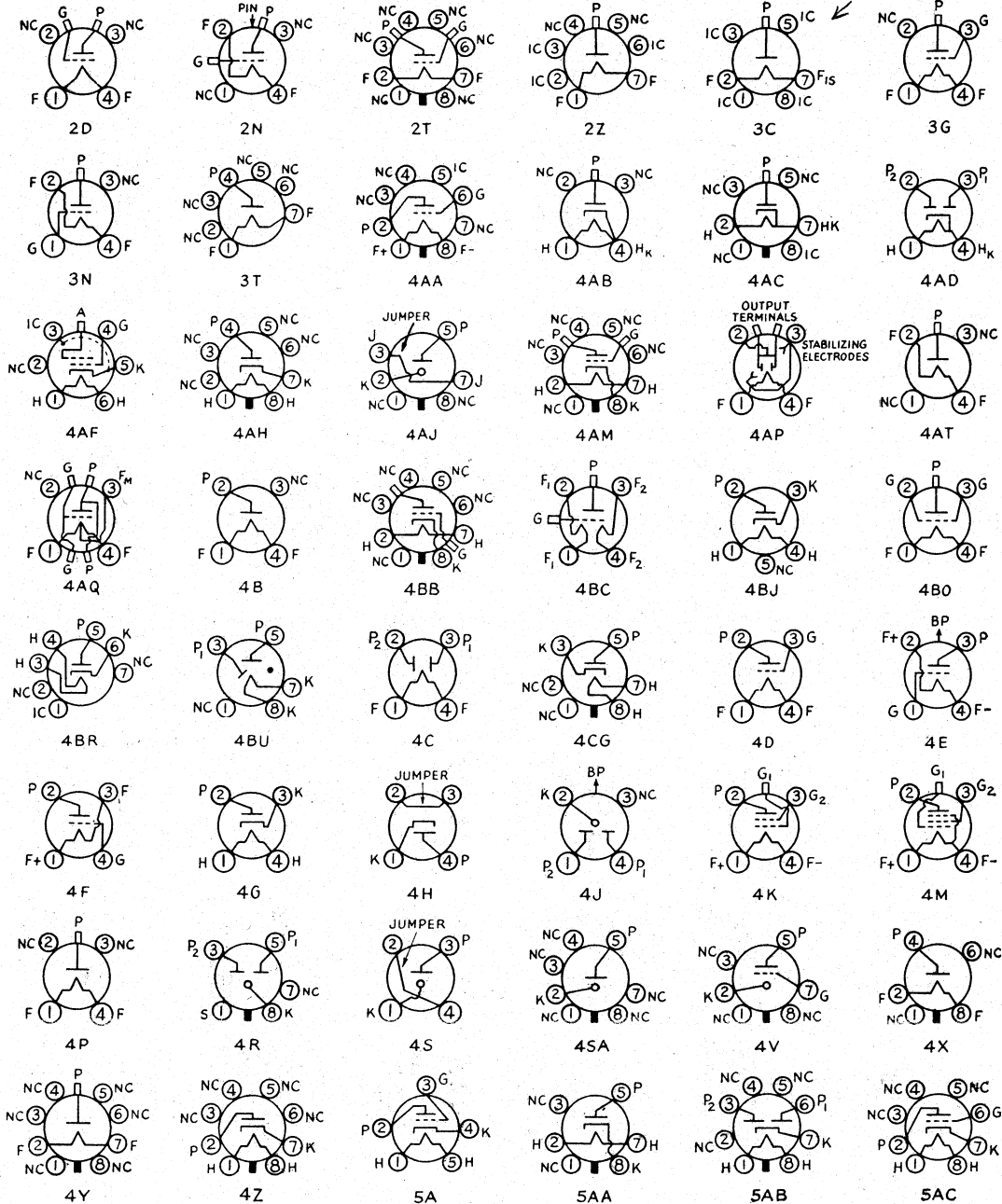

# RECEIVING TUBE SUBSTITUTION GUIDE

## R.M.A. TUBE BASE DIAGRAMS

Bottom views are shown.

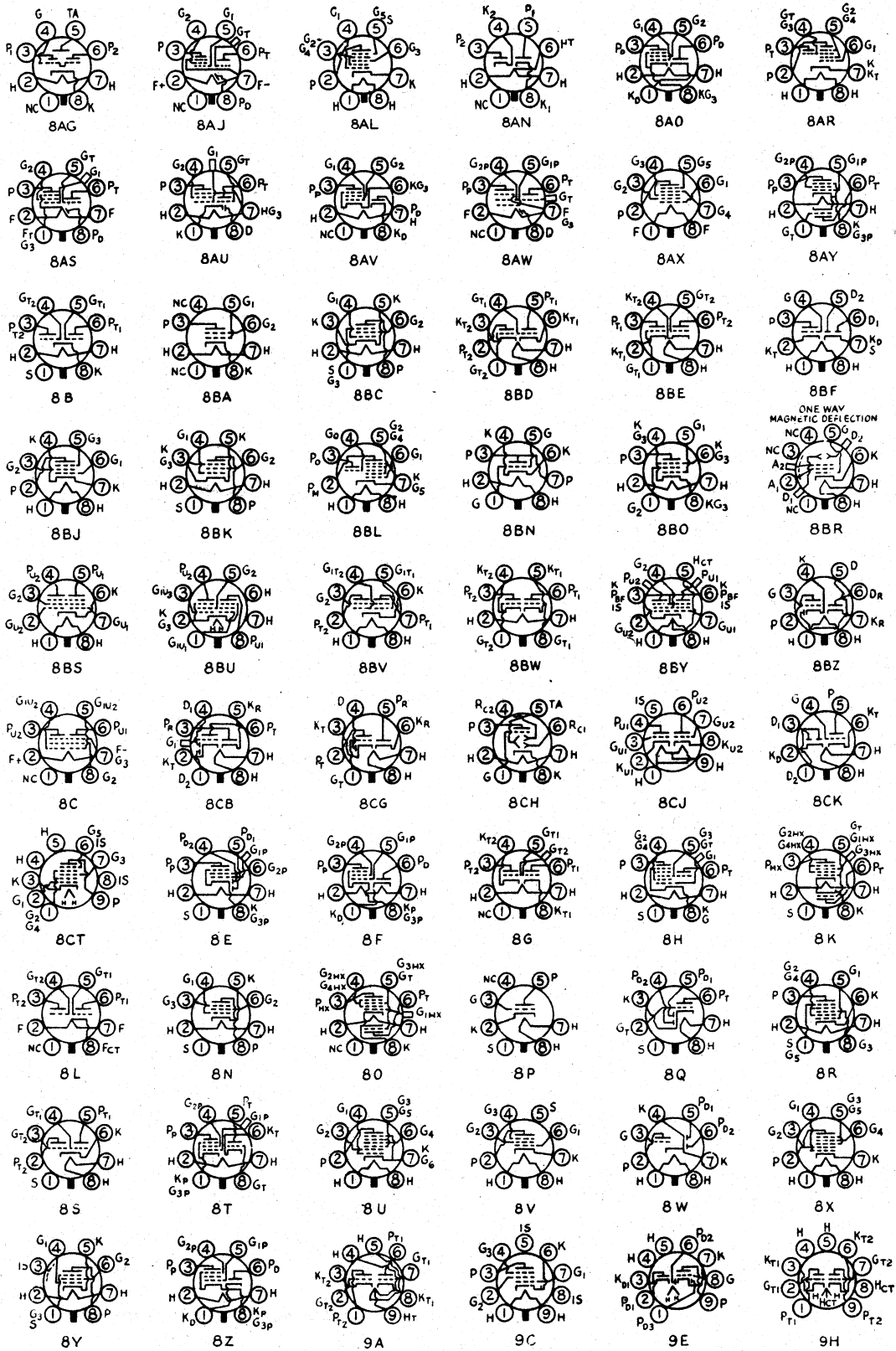



# RECEIVING TUBE SUBSTITUTION GUIDE

## R.M.A. TUBE BASE DIAGRAMS

Bottom views are shown.

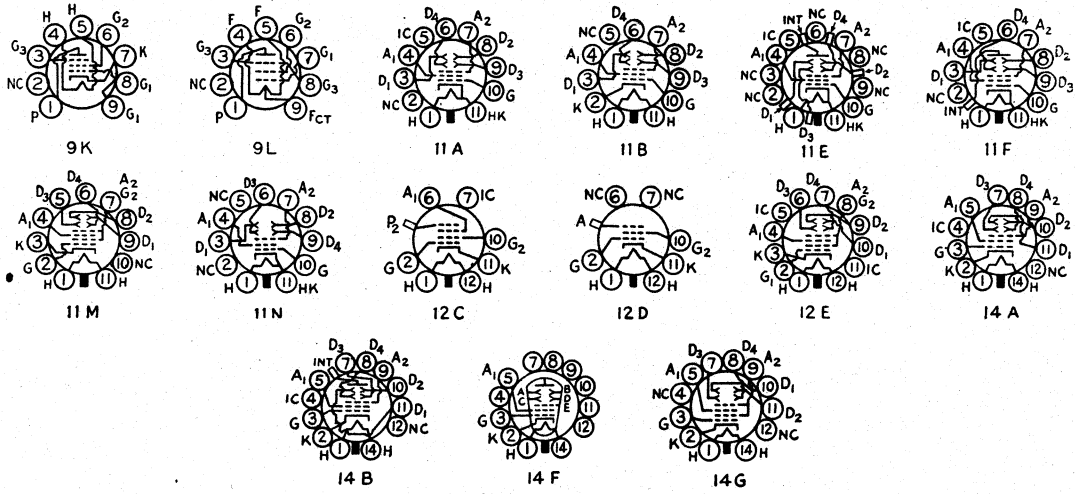

## SUPPLEMENTARY BASE DIAGRAMS

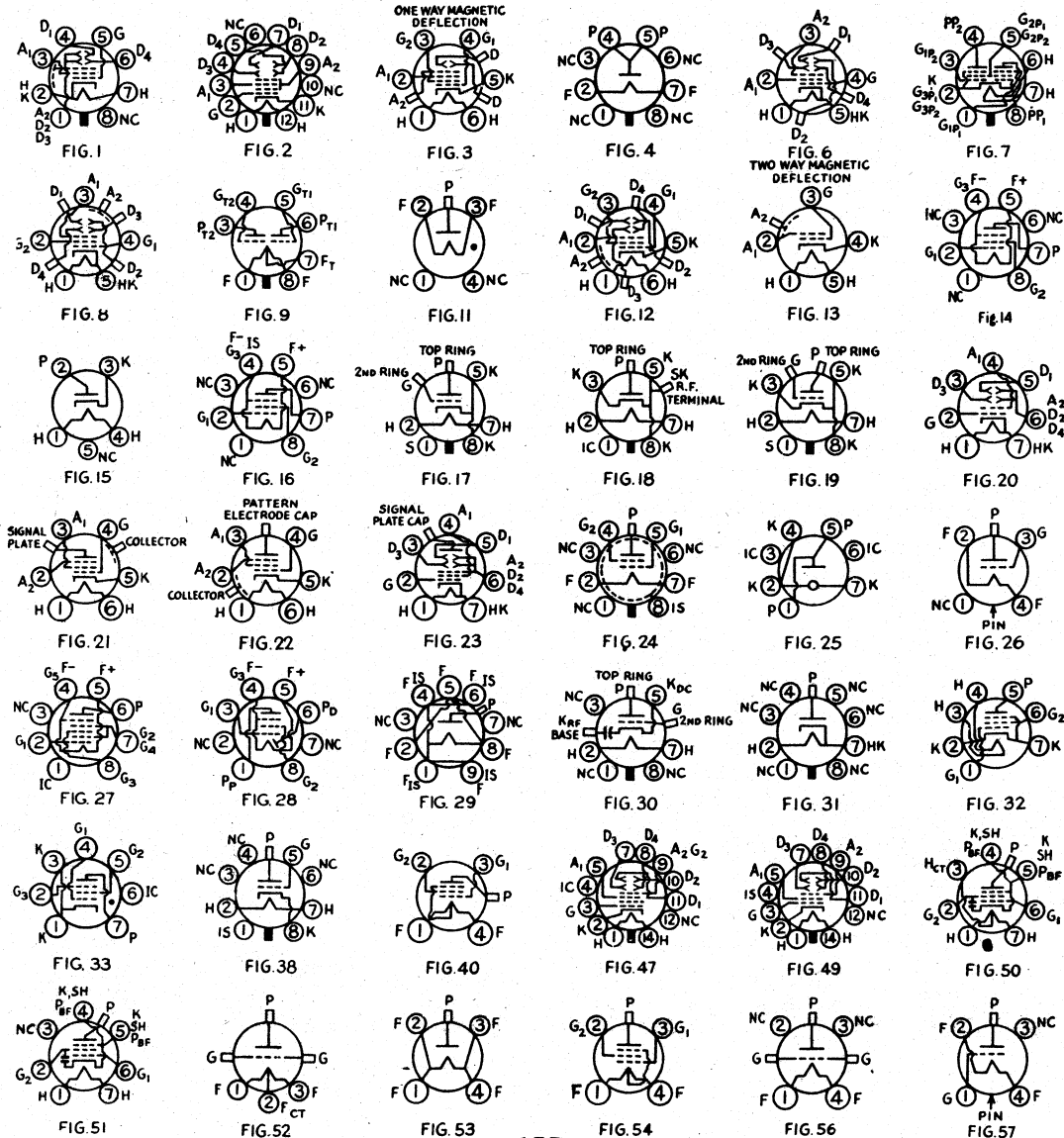

# RECEIVING TUBE SUBSTITUTION GUIDE

## R.M.A. TUBE BASE DIAGRAMS

Bottom views are shown.

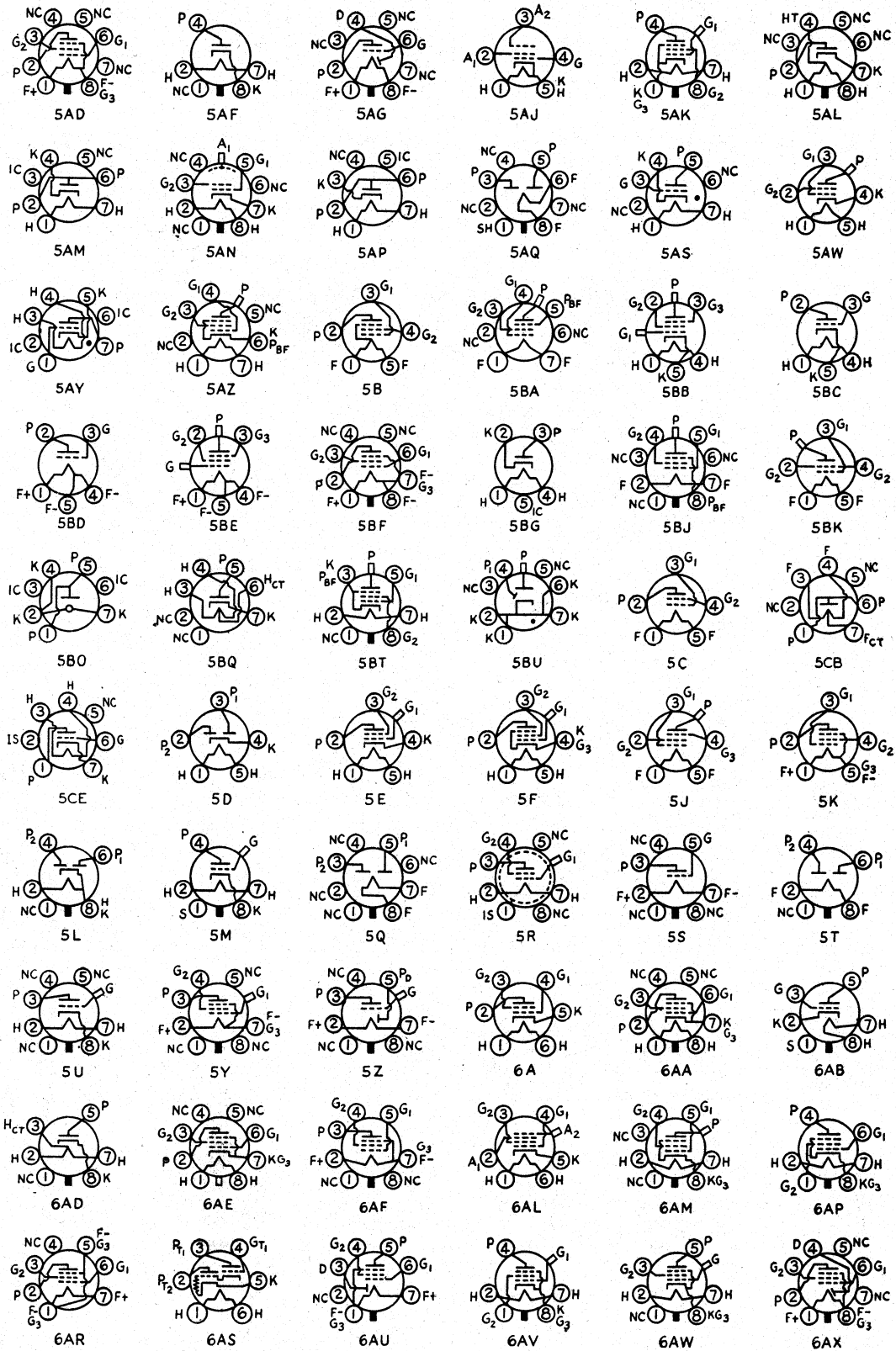

# RECEIVING TUBE SUBSTITUTION GUIDE

## R.M.A. TUBE BASE DIAGRAMS

Bottom views are shown.

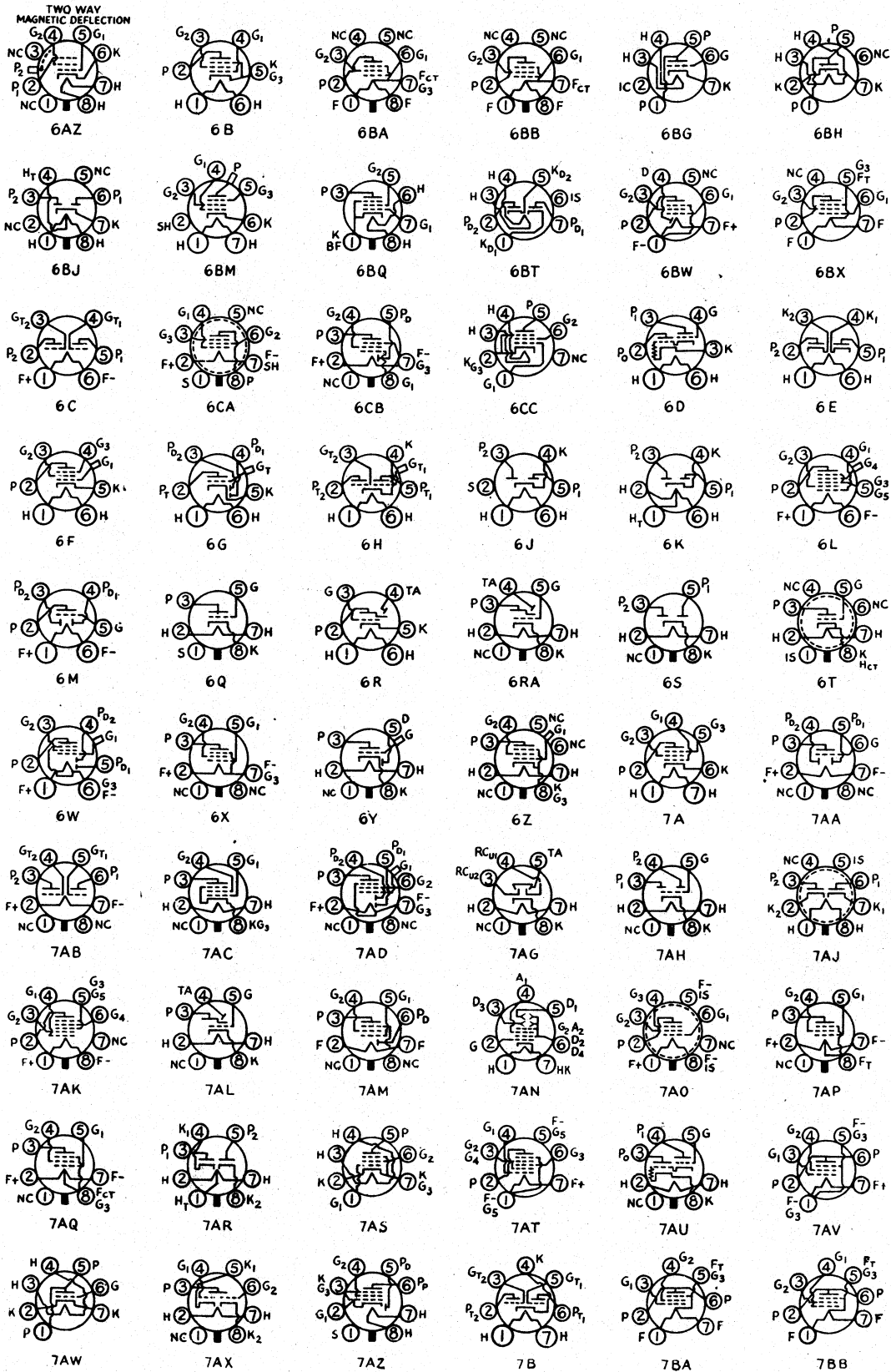



RECEIVING TUBE CHARACTERISTICS

TABLE I—METAL RECEIVING TUBES

Characteristics given in this table apply to all tubes having type numbers shown, including metal tubes with "G" suffix, and bantam tubes with "GT" suffix. For "G" and "GT" tubes not listed (not having metal counterparts), see Tables II, VII, VIII and IX.

Type	Name	Socket Connections	Fil. or Heater		Capacitance $\mu$ fd.		Plate-Grid	Use	Plate Supply Volts	Grid Bias Volts	Screen Volts	Screen Current Ma.	Plate Current Ma.	Plate Resistance Ohms	Transcon-ductance Micromhos	Amp. Factor	Load Resistance Ohms	Power Output Watts	Type
			Volts	Amp.	In	Out													
6A8	Pentagrid Converter	8A	6.3	0.3	—	—	—	Osc.-Mixer	250	-3.0	100	3.2	3.3	Anode-grid (No. 2) 250 volts max. thru 20,000 ohms	—	3500	—	—	6A8
6AB7	Television Amp. Pentode	8N	6.3	0.45	8	5	0.015	Class-A Amp.	300	-3.0	200	3.2	12.5	700000	5000	—	—	—	6AB7
6AC7	Television Amp. Pentode	8N	6.3	0.45	11	5	0.015	Class-A Amp.	300	160*	150	2.5	10	1000000	9000	—	—	—	6AC7
6AG7	Sharp Cut-off Pentode	8Y	6.3	0.65	13	7.5	0.06	Class-A Amp.	300	160*	150	7/9	30/30.5	130000	11000	—	—	—	6AG7
6AJ7	Sharp Cut-off Pentode	8Y	6.3	0.45	—	—	—	Class-A Amp.	300	160*	300	2.5	10	1000000	9000	—	—	—	6AJ7
6AK7	Pentode Power Amp.	8Y	6.3	0.65	13	7.5	0.06	Class-A Amp.	300	-3	150	7	30	130000	11000	—	—	—	6AK7
6BB	Duplex-Diode Pentode	8E	6.3	0.3	6	9	0.005	Class-A Amp.	250	-3.0	125	2.3	9.0	650000	1125	730	—	—	6BB
6C5	Triode	6Q	6.3	0.3	3	11	2	Class-A Amp.	250	-8.0	—	—	8.0	10000	2000	—	—	—	6C5
6F5	High- $\mu$ Triode	5M	6.3	0.3	5.5	4	2.3	Class-A Amp.	250	-17.0	—	—	—	Plate current adjusted to 0.2 ma. with no signal	—	—	—	—	6F5
								Class-A Pent.	250	-1.3	—	—	0.2	66000	1500	100	—	—	—
								Class-A Triode 1	250	-16.5	250	6.5	36.7	80000	2500	200	7000	3.2	—
								Class-A Triode 2	315	-22.0	315	8.0	42	75000	2650	200	7000	3.0	—
6F6	Pentode Power Amplifier	75	6.3	0.7	6.5	13	0.2	Class-AB; Amp. <sup>5</sup> Class-AB; Amp. <sup>6</sup> Class-AB; Amp. <sup>10</sup>	250 375 350	-20.0 340* 730*	— 250 250	— 8/18 5/19.5	— 54/77 34/82	2600 Power output for 2 tubes at stated load, plate-to-plate	2500 4000 10000*	6.8 6.8 19.0	4000 4000 10000*	0.85 0.85 18.5	6F6
6H6	Twin Diode	7Q	6.3	0.3	—	—	—	Rectifier	250	—	—	—	—	Max. a.c. voltage per plate = 150 r.m.s. Max. output current 8.0 ma. d.c.	—	—	—	—	6H6
6J5	Triode	6Q	6.3	0.3	3.4	3.6	3.4	Class-A Amp.	250	-8.0	—	—	9	7700	2600	2.0	—	—	6J5
6J7	Sharp Cut-off Pentode	7R	6.3	0.3	7	12	0.005	R.F. Amp.	250	-3.0	100	0.5	2.0	1.5 meg.	1225	1500	—	—	6J7
6K7	Variable- $\mu$ Pentode	7R	6.3	0.3	7	12	0.005	R.F. Amp.	250	-4.3	100	—	—	Cathode current 0.43 ma.	—	—	0.5 meg.	—	6K7
6K8	Triode-Hexode	8K	6.3	0.3	—	—	—	Mixer	250	-3.0	125	2.6	10.5	600000	1650	990	—	—	6K8
								Converter	250	-10.0	100	—	—	—	Oscillator peak volts = 7.0	—	—	—	—
								Single Tube Class A <sub>1</sub>	250	-3.0	100	6	2.5	Triode Plate (No. 2) 100 volts, 3.8 ma.	—	—	2300	6.5	—
								Class A <sub>1</sub>	250	170*	250	5.4/7.2	75/78	—	—	—	4500	6.5	—
								Class A <sub>1</sub>	300	220*	200	3.0/4.6	51/54.5	—	—	—	2500	6.5	—
								Class A <sub>1</sub>	250	-14.0	250	5.0/7.3	72/79	—	—	—	4200	10.8	—
								Class A <sub>1</sub>	350	-18.0	250	2.5/7.0	54/66	—	—	—	5000*	18.5	—
6L6	Beam Power Amplifier	7AC	6.3	0.9	10	12	0.4	P.P. Class A <sub>1</sub> <sup>6</sup>	270	125*	270	11/17	134/145	—	—	—	5000*	14.5	—
								P.P. Class A <sub>1</sub> <sup>6</sup>	250	-16.0	250	10/16	120/140	—	—	—	5000*	17.5	—
								P.P. Class A <sub>1</sub> <sup>6</sup>	270	-17.5	270	11/17	134/155	—	—	—	9000*	24.5	—
								P.P. Class AB <sub>1</sub> <sup>7</sup>	360	250*	270	5/17	88/100	—	—	—	6000*	31.0	—
								P.P. Class AB <sub>1</sub> <sup>8</sup>	360	-22.5	270	5/15	88/132	—	—	—	3800*	47.0	—
								P.P. Class AB <sub>1</sub> <sup>9</sup>	360	-18.0	225	3.5/11	78/142	—	—	—	—	—	—
								P.P. Class AB <sub>1</sub> <sup>10</sup>	360	-22.5	270	5/16	88/205	—	—	—	—	—	—
6L7	Pentagrid Mixer Amplifier	7T	6.3	0.3	—	—	—	R.F. Amp.	250	-3.0	100	5.5	5.3	800000	1100	—	—	—	6L7
6N7	Twin Triode	8B	6.3	0.8	—	—	—	Mixer	250	-6.0	150	8.3	3.3	Over 1 meg.	Oscillator-grid (No. 3) voltage = 15	—	—	—	6N7
6Q7	Duplex-Diode Triode	7V	6.3	0.3	5	3.8	1.4	Class-B Amp.	300	0	—	—	35/70	—	—	8000	10.0	—	
6R7	Duplex-Diode Triode	7V	6.3	0.3	4.8	3.8	2.4	Triode Amp.	250	-3.0	—	—	1.1	58000	1200	70	—	—	
6S7	Remote Cut-off Pentode	7R	6.3	0.15	6.5	10.5	0.005	Triode Amp.	250	-9.0	—	—	8.5	8500	1900	16	10000	0.28	6R7
6SA7	Pentagrid Converter	BR <sup>2</sup>	6.3	0.3	—	—	—	Class-A Amp.	250	-3.0	100	2.0	8.5	1000000	1750	—	—	—	6S7
								Converter	250	0 <sup>1</sup>	100	8.0	3.4	800000	Grid No. 1 resistor 20000 ohms	—	—	—	—
								Converter	100	-1	100	10.2	3.6	500000	930	—	—	—	—
6SB7Y	Pentagrid Converter	8R	6.3	0.3	9.6	9.2	—	Converter	250	-1	100	10	3.8	1000000	950	—	—	—	6SB7Y
6SC7	Twin-Triode	8S	6.3	0.3	—	—	—	Osc. Section in 88-108 Mc. Serv.	250	22000 <sup>10</sup>	1200 <sup>11</sup>	12.6/12.5	6.8/5.5	—	—	—	—	—	—
6SF5	High- $\mu$ Triode	6AB	6.3	0.3	4	3.6	2.4	Class-A Amp.	250	-2.0	—	—	2.0	53000	1325	70	—	—	6SF5
								Class-A Amp.	250	-2.0	—	—	0.9	66000	1500	100	—	—	—

Courtesy ARRL Handbook

RECEIVING TUBE SUBSTITUTION GUIDE

TABLE I—METAL RECEIVING TUBES—Continued

Type	Name	Socket Connections	Fil. or Heater		Capacitance $\mu$ fd.		Plate-Grid	Use	Plate Supply Volts	Grid Bias	Screen Volts	Screen Current Ma.	Plate Current Ma.	Plate Resistance Ohms	Transconductance Micromhos	Amp. Factor	Load Resistance Ohms	Power Output Watts	Type	
			Volts	Amp.	In	Out														
6SF7	Diode Variable- $\mu$ Pentode	7AZ	6.3	0.3	5.5	6	0.004	Class-A Amp.	250	-1.0	100	3.3	12.4	700000	2050	—	—	—	6SF7	
6SG7	Semivariable- $\mu$ Pentode	8BK	6.3	0.3	8.5	7	0.003	H.F. Amp.	250	-2.5	150	3.4	9.2	Over 1 meg.	4000	—	—	—	6SG7	
6SH7	Sharp Cut-off Pentode	8BK	6.3	0.3	8.5	7	0.003	Class-A Amp.	250	-1.0	150	4.1	10.8	900000	4900	—	—	—	6SH7	
6SJ7 <sup>1</sup>	Sharp Cut-off Pentode	8N	6.3	0.3	6	7	0.005	Class-A Amp.	250	-3.0	100	0.8	3	1500000	1650	2500	—	—	6SJ7	
6SK7	Variable- $\mu$ Pentode	8N	6.3	0.3	6	7	0.003	Class-A Amp.	250	-3.0	100	2.4	9.2	800000	2000	1600	—	—	6SK7	
6SQ7	Variable- $\mu$ Pentode	8Q	6.3	0.3	3.2	3.0	1.6	Class-A Amp.	250	-2.0	—	—	—	91000	1100	100	—	—	6SQ7	
6SR7	Duplex-Diode Triode	8Q	6.3	0.3	3.6	2.8	2.40	Class-A Amp.	250	-9.0	—	—	—	8500	1900	16	—	—	6SR7	
6S7	Variable- $\mu$ Pentode	8N	6.3	0.15	5.5	7.0	0.004	Class-A Amp.	250	-3.0	100	2.0	9.5	1000000	1850	—	—	—	6S7	
6ST7	Duplex-Diode Triode	8Q	6.3	0.15	2.8	3	1.50	Class-A Amp.	250	-9.0	—	—	—	8500	1900	16	—	—	6ST7	
6SV7	Diode R. F. Pentode	7AZ	6.3	0.3	6.5	6	0.004	Class-A Amp.	250	-1	150	2.8	7.5	800000	3400	—	—	—	6SV7	
6SZ7	Duplex-Diode Triode	8Q	6.3	0.15	2.6	2.8	1.10	Class-A Amp.	250	-3	—	—	—	58000	1200	70	—	—	6SZ7	
6T7	Duplex-Diode Triode	7V	6.3	0.15	1.8	3.1	1.70	Class-A Amp.	250	-3.0	—	—	—	62000	1050	65	—	—	6T7	
6V6	Beam Power Amplifier	7AC	6.3	0.45	2.0	7.5	0.7	Class-A <sub>1</sub> Amp. <sup>5</sup> Class-AB <sub>1</sub> Amp. <sup>6</sup>	250 285	-12.5 -19.0	250 285	4.5/7.0 4/13.5	45/47 70/92	52000 65000	4100 3600	218 —	5000 8000 <sup>8</sup>	4.5 14.0	—	6V6
1611	Pentode Power Amplifier	7S	6.3	0.7	—	—	—	Audio Amp.	250	-3.0	100	6.5	—	Characteristics same as 6F6	—	—	—	—	1611	
1612	Pentagrid Amplifier	7T	6.3	0.3	7.5	11	0.001	Class-A Amp.	250	—	—	—	—	600000	1100	880	—	—	1612	
1620	Sharp Cut-off Pentode	7R	6.3	0.3	—	—	—	Class-A Amp.	300	-30.0	300	6.5/13	38/69	—	—	—	4000 <sup>8</sup>	5.0	—	1620
1621	Power Amplifier Pentode	7S	6.3	0.7	—	—	—	Class-AB <sub>1</sub> Amp. <sup>6</sup> Class-A <sub>1</sub> Amp. <sup>1</sup>	300 330	500 <sup>7</sup>	—	—	—	—	—	—	5000 <sup>8</sup>	2.0	—	1621
1622	Beam Power Amplifier	7AC	6.3	0.9	—	—	—	Class-A <sub>1</sub> Amp.	300	-20.0	250	4/10.5	86/125	—	—	—	4000	10.0	—	1622
1851	Television Amp. Pentode	7R	6.3	0.45	11.5	5.2	0.02	Class-A Amp.	300	-2.0	150	2.5	10	750000	9000	6750	—	—	—	1851
5693	Sharp Cut-off Pentode	8N	6.3	0.3	5.3	6.2	0.005	Class-A Amp.	250	-3	100	0.85	3.0	1000000	1650	—	—	—	—	5693

\* Cathode resistor—ohms.  
<sup>1</sup> Screen tied to plate.  
<sup>2</sup> For 6SA7GT use base diagram 8AD.  
<sup>3</sup> Grid bias—2 volts if separate oscillator excitation is used.  
<sup>4</sup> Also Type "6SJ7".  
<sup>5</sup> Values are for single tube.  
<sup>6</sup> Values are for two tubes in push-pull.  
<sup>7</sup> Max.-signal value.  
<sup>8</sup> Plate-to-plate value.  
<sup>9</sup> Occ. grid leak—Scr. res.

TABLE II—6.3-VOLT GLASS TUBES WITH OCTAL BASES

Type	Name	Socket Connections	Fil. or Heater		Capacitance $\mu$ fd.		Plate-Grid	Use	Plate Supply Volts	Grid Bias	Screen Volts	Screen Current Ma.	Plate Current Ma.	Plate Resistance Ohms	Transconductance Micromhos	Amp. Factor	Load Resistance Ohms	Power Output Watts	Type			
			Volts	Amp.	In	Out																
2C22	Triode	4AM	6.3	0.3	2.2	0.7	3.60	Class-A Amp.	300	-10.5	—	—	11	6600	3000	20	—	—	—	2C22		
6A5G	Triode Power Amplifier	6T	6.3	1.0	—	—	—	Class-A Amp. <sup>4</sup> P.P. Class AB <sup>5</sup> P.P. Class AB <sup>5</sup>	250 325 325	-45.0 -68.0 850 <sup>6</sup>	—	—	60	800	5250	4.2	2500	3.75 15.0 10.0	—	—	6A5G	
6AB6G	Direct-Coupled Amplifier	7AU	6.3	0.5	—	—	—	Class-A Amp.	250	0	Input Output	5.0	3.4	40000	1800	72	8000	3.5	—	—	6AB6G	
6AC5G	High- $\mu$ Power-Amplifier Triode	6Q	6.3	0.4	—	—	—	P.P. Class B <sup>5</sup> Dyn.-Coupled	250 250	0 —	—	—	5.0	32	36700	3400	125	10000 <sup>8</sup> 7000	8.0 3.7	—	—	6AC5G
6AC6G	Direct-Coupled Amplifier	7AU	6.3	1.1	—	—	—	Class-A Amp.	180	0	Input Output	7.0	4.5	—	3000	54	4000	3.8	—	—	6AC6G	
6AD5G	High- $\mu$ Triode	6Q	6.3	0.3	4.1	3.9	3.3	Class-A Amp.	250	-2.0	—	—	0.9	1500	100	—	—	—	—	—	6AD5G	
6AD6G <sup>10</sup>	Electron-Ray Tube	7AG	6.3	0.15	—	—	—	Indicator	100	—	—	—	—	—	—	—	—	—	—	—	6AD6G	
6AD7G	Triode-Pentode	8AY	6.3	0.85	—	—	—	Triode Amp.	250	-25.0	—	—	4.0	19000	325	6.0	—	—	—	—	6AD7G	
6AE5G <sup>10</sup>	Triode-Pentode	6Q	6.3	0.3	—	—	—	Class-A Amp.	250	-16.5	250	6.5	3.4	80000	2500	—	7000	3.2	—	—	6AE5G	
6AE6GT <sup>10</sup>	Twin-Plate Triode with Single Grid	7AH	6.3	0.15	—	—	—	Class-A Amp.	250	-1.5	—	—	7.0	3500	1200	4.2	—	—	—	—	6AE6GT	
					Remote cut-off	Sharp cut-off		Class-A Amp.	250	-1.5	—	—	6.5	25000	1000	25	—	—	—	—	—	6AE6GT

<sup>10</sup> For 6SA7GT use base diagram 8AD.

Courtesy ARRL Handbook

RECEIVING TUBE SUBSTITUTION GUIDE

TABLE II—6.3-VOLT GLASS TUBES WITH OCTAL BASES—Continued

Type	Name	Socket Connections	Fil. or Heater		Capacitance $\mu\text{fd.}$		Plate-Grid	Use	Plate Supply Volts	Grid Bias	Screen Volts	Screen Current Ma.	Plate Current Ma.	Plate Resistance Ohms	Transcon-ductance Micromhos	Amp. Factor	Load Resistance Ohms	Power Output Watts	Type
			Volts	Amp.	In	Out													
6AE7GT <sup>10</sup>	Twin-Input Triode	7AX	6.3	0.5	—	—	—	Driver Amplifier	250	-13.5	—	—	5.0	9300	1500	14	—	6AE7GT	
6AF5G	Triode	6Q	6.3	0.3	—	—	—	Class-A Amplifier	180	-18.0	—	—	7.0	—	1500	7.4	—	6AF5G	
6AF7G	Twin Electron Ray	8AG	6.3	0.3	—	—	—	Indicator Tube	250	-6.0	250	6.0	32	—	10000	—	8500	3.75	6AG6G
6AG6G	Power-Amplifier Pentode	7S	6.3	1.25	—	—	—	Class-A Amplifier	350	-18	250	—	—	33000	5200	—	4200	10.8	6AH5G
6AH5G	Beam Power Amplifier	6AP	6.3	0.9	—	—	—	Class-A Amplifier	250	-9.0	—	—	—	6000	2400	16	—	6AH7GT	
6AH7GT	Twin Triode	8BE	6.3	0.3	—	—	—	Converter & Amp.	250	-14.0	250	5.0	72	22500	6000	—	2500	6.5	6AL6G
6AL6G	Beam Power Amplifier	6AM	6.3	0.9	—	—	—	Class-A Amplifier	250	Edge of any of the three illuminated areas displaced $\frac{1}{16}$ in. min. outward with $\pm 5$ volts to its electrode. Similar inward disp. with $-5$ volts. No pattern with $-6$ volts grid.	—	—	—	—	—	—	—	—	6AL7GT
6AL7GT	Electron-Ray Tube	8CH	6.3	0.15	—	—	—	Indicator	250	-2.0	—	—	2.3	44000	1600	—	—	—	
6AQ7GT	Duplex Diode Triode	8CK	6.3	0.3	2.3	1.5	2.8	Class-A Amplifier	250	-22.5	250	5	77	21000	5400	95	—	6AR6	
6AR6	Beam Power Amp.	6BQ	6.3	1.2	11	7	0.55	Class-A Amplifier	250	-2	—	—	—	64500	1050	70	—	6AR7GT	
6AR7GT	Diode Triode	8CG	6.3	0.3	1.4	1	2	Class-A Amplifier	250	-4.5	—	—	—	26000	1450	38	—	6C8G	
6AS7G	Low-Mu Twin Triode	8BD	6.3	2.5	—	—	—	D.C. Amplifier	135	250*	—	—	125	280	7500	2.1	—	6A57G	
								Class-A1 Amp. P.P.	250	2500*	—	—	100/106	280	225 <sup>v</sup>	—	6000 <sup>6</sup>	13	
6B4G	Triode Power Amplifier	5S	6.3	1.0	—	—	—	Power Amplifier	250	-2.0	—	—	—	—	—	—	—	—	6B4G
6B6G	Duplex-Diode High- $\mu$ Triode	7V	6.3	0.3	1.7	3.8	1.7	Detector-Amplifier	250	47*	150	2.1	45	—	5500	—	—	—	6B6G
6BQ6GT	Beam Pentode	6AM	6.3	1.2	—	—	—	Deflection Amp.	400	-50	350	6.0	70	—	6000	—	—	—	6BQ6GT
6BG6	Beam Power Amplifier	5BT	6.3	0.9	11	6.5	0.5	Deflection Amp.	250	-4.5	—	—	—	26000	1450	38	—	6B6G	
6BG8G	Twin Triode	8G	6.3	0.3	—	—	—	Amp. 1 Section	250	-3.0	100	—	—	—	—	—	—	—	6C8G
6BR8G	Pentagrid Converter	8A	6.3	0.15	—	—	—	Converter	250	-3.0	100	2.8	1.2	—	—	—	—	—	6D8G
6B13	Triode-Hexode Converter	80	6.3	0.3	—	—	—	Converter	250	-2.0	—	—	—	—	—	—	—	—	6E8G
6B15	Twin Triode	8G	6.3	0.6	—	—	—	Amplifier	250	-8.0	—	—	9.1	7700	2600	20	—	—	6E8G
6G6G	Pentode Power Amplifier	7S	6.3	0.15	—	—	—	Class-A Amplifier	180	-9.0	180	2.5	15	175000	2300	400	10000	1.1	6G6G
6H4GT	Diode Rectifier	5AF	6.3	0.15	—	—	—	Class-A Amplifier	180	-12.0	—	—	—	4750	2000	9.5	12000	0.25	6H4GT
6H8G	Diode Diode High- $\mu$ Pentode	8E	6.3	0.3	—	—	—	Detector	100	-2.0	100	—	—	—	—	—	—	—	6H8G
6J8G <sup>10</sup>	Triode Heptode	8H	6.3	0.3	—	—	—	Class-A Amplifier	250	-3.0	100	2.8	1.2	—	—	—	—	—	6J8G
6K5GT <sup>10</sup>	High- $\mu$ Triode	5U	6.3	0.3	2.4	3.6	2.0	Converter	250	-3.0	100	2.8	1.2	—	—	—	—	—	6K5GT
6K6GT	Pentode Power Amplifier	7S	6.3	0.4	—	—	—	Class-A Amplifier	250	-3.0	—	—	—	50000	1400	70	—	—	6K6GT
6L5G	Triode Amplifier	6Q	6.3	0.15	2.8	5.0	2.8	Class-A Amplifier	250	-9.0	—	—	8.0	—	1900	17	—	—	6L5G
6M6G	Power Amplifier Pentode	7S	6.3	1.2	—	—	—	Class-A Amplifier	250	-6.0	250	4.0	36	—	9500	—	7000	4.4	6M6G
6M7G	Pentode Amplifier	7R	6.3	0.3	—	—	—	R.F. Amplifier	250	-2.5	125	2.8	10.5	900000	3400	—	—	—	6M7G
6M8GT	Diode Triode Pentode	8AU	6.3	0.6	—	—	—	Triode Amplifier	100	-3.0	100	—	—	91000	1100	—	—	—	6M8GT
6N6G <sup>10</sup>	Direct-Coupled Amplifier	7AU	6.3	0.8	—	—	—	Pentode Amplifier	100	-3.0	100	8.5	8.5	200000	1900	—	—	—	6N6G
6P5GT <sup>10</sup>	Triode Amplifier	6Q	6.3	0.3	3.4	5.5	2.6	Power Amplifier	250	-13.5	—	—	5.0	9500	1450	13.8	—	—	6P5GT
6P7G <sup>10</sup>	Triode-Pentode	7U	6.3	0.3	—	—	—	Class-A Amplifier	250	-13.5	—	—	—	—	—	—	—	—	6P7G
6P8G	Triode-Hexode Converter	8K	6.3	0.8	—	—	—	Class-A Amplifier	250	-2.0	75	1.4	1.5	—	—	—	—	—	6P8G
6Q6G	Diode-Triode	6Y	6.3	0.15	—	—	—	Converter	250	-3.0	—	—	—	—	—	—	—	—	6Q6G
6R6G	Pentode Amplifier	6AW	6.3	0.3	4.5	11	0.007	Class-A Amplifier	250	-3.0	100	1.7	7.0	—	1050	65	—	—	6R6G
6S6GT	Remote Cut-off Pentode	5AK	6.3	0.45	—	—	—	R.F. Amplifier	250	-2.0	100	3.0	13	350000	4000	—	—	—	6S6GT
6S8GT	Triode Diode Triode	8CB	6.3	0.3	1.2	5	2	Class-A Amplifier	250	-2.0	100	1.9	6.0	91000	1100	100	—	—	6S8GT
6SD7GT	Medium Cut-off Pentode	8M	6.3	0.3	9	7.5	.0035	R.F. Amplifier	250	-2.0	100	1.5	4.5	1100000	3600	3750	—	—	6SD7GT
6SE7GT	Sharp Cut-off Pentode	8N	6.3	0.3	8	7.5	.005	R.F. Amplifier	250	-1.5	100	1.5	4.5	1100000	3400	3750	—	—	6SE7GT
6SH7L	Pentode R.F. Amp.	8BK	6.3	0.3	—	—	—	Class-A Amplifier	100	-1.0	100	2.1	6.3	350000	4000	—	—	—	6SH7L
6SL7GT	Twin Triode	8BD	6.3	0.3	—	—	—	Class-A Amplifier	250	-1.0	150	4.1	10.8	900000	4900	—	—	—	6SL7GT
6SN7GT	Twin Triode	8BD	6.3	0.6	—	—	—	Class-A Amplifier	250	-2.0	—	—	2.3	44000	1600	70	—	—	6SN7GT

Courtesy ARRL Handbook



RECEIVING TUBE SUBSTITUTION GUIDE

TABLE II--6.3-VOLT GLASS TUBES WITH OCTAL BASES--Continued

Type	Name	Socket Connections	Fil. or Heater		Capacitance $\mu$ fd.			Use	Plate Supply Volts	Grid Bias	Screen Volts	Screen Current Ma.	Plate Current Ma.	Plate Resistance Ohms	Transcon-ductance Micromhos	Amp. Factor	Load Resistance Ohms	Power Output Watts	Type
			Volts	Amp.	In	Out	Plate-Grid												
6SU7GT	Twin Triode	8BD	6.3	0.3	—	—	—	250	-2.0	—	—	2.3	44000	1600	70	—	—	6SU7GT	
6T6GM <sup>10</sup>	Beam Power Amplifier	6Z	6.3	0.45	—	—	—	250	-1.0	100	2.0	10	1000000	5500	—	—	—	6T6GM	
6U6GT	Beam Power Amplifier	7AC	6.3	0.75	—	—	—	200	-14.0	135	3.0	56	20000	6200	—	3000	5.5	6U6GT	
6V7G	Variable- $\mu$ Pentode	7R	6.3	0.3	5	9	.007	—	—	—	—	—	—	—	—	—	—	6V7G	
6V7G <sup>10</sup>	Duplex Diode-Triode	7V	6.3	0.3	2	3.5	1.7	—	—	—	—	—	—	—	—	—	—	6V7G	
6W6GT	Beam Power Amplifier	7AC	6.3	1.25	—	—	—	135	-9.5	135	12.0	61.0	9000	215	2000	—	3.3	6W6GT	
6W7G	Pentode Det. Amplifier	7R	6.3	0.15	5	8.5	.007	250	-3.0	100	2.0	0.5	1500000	1225	1850	—	—	6W7G	
6X6G	Electron-Ray Tube	7AL	6.3	0.3	—	—	—	250	—	—	—	—	—	—	—	—	—	6X6G	
6Y6G	Beam Power Amplifier	7AC	6.3	1.25	15	8	0.7	135	-13.5	135	3.0	60.0	9300	7000	—	2000	3.6	6Y6G	
6Y7G <sup>10</sup>	Twin Triode Amplifier	8B	6.3	0.3	—	—	—	135	-13.5	135	3.0	60.0	9300	7000	—	2000	3.6	6Y7G	
6Z7G	Twin Triode Amplifier	8B	6.3	0.3	—	—	—	180	0	—	—	8.4	—	—	—	12000	4.2	6Z7G	
717A	Sharp Cut-off Pentode	8BK	6.3	0.175	—	—	—	135	0	—	—	6.0	—	—	—	9000	2.5	717A	
1223	Sharp Cut-off Pentode	7R	6.3	0.3	—	—	—	120	-2.0	120	2.5	7.5	390000	4000	—	—	—	1223	
1635	Twin Triode Amplifier	8B	6.3	0.6	—	—	—	—	—	—	—	—	—	—	—	—	—	1635	
5691	Hi-Mu Twin Triode	8BD	6.3	0.6	2.4	2.3	3.6	400	0	—	—	—	—	—	—	14000	17	1635	
5692	Medium-Mu Twin Triode	8BD	6.3	0.6	2.7	2.5	3.7	250	-2	—	—	—	—	—	—	—	—	5691	
7000	Low-Noise Amplifier	7R	6.3	0.3	2.6	2.7	3.8	250	-9	—	—	—	—	—	—	—	—	5692	
								250	-9	—	—	—	—	—	—	—	—	7000	

\* Cathode resistor-ohms. <sup>1</sup> Per plate. <sup>2</sup> Screen tied to plate. <sup>3</sup> Through 70,000-ohm dropping resistor. <sup>4</sup> Values are for single tube. <sup>5</sup> Values are for two tubes in push-pull. <sup>6</sup> Plate-to-plate value. <sup>7</sup> No. 1 triode. <sup>8</sup> No. 2 triode. <sup>9</sup> Peak a.f. volts G-G. <sup>10</sup> Discontinued.

TABLE III--7-VOLT LOCK-IN-BASE TUBES  
For other lock-in-base types see Tables VIII, IX, and X

Type	Name	Socket Connections	Heater		Capacitance $\mu$ fd.			Use	Plate Supply Volts	Grid Bias	Screen Volts	Screen Current Ma.	Plate Current Ma.	Plate Resistance Ohms	Transcon-ductance Micromhos	Amp. Factor	Load Resistance Ohms	Power Output Watts	Type
			Volts	Amp.	In	Out	Plate-Grid												
7A4	Triode Amplifier	5AC	7.0	0.32	3.4	3	4	Class-A Amplifier	250	-8.0	—	—	9.0	7700	2600	—	—	—	7A4
7A5	Beam Power Amplifier	6AA	7.0	0.75	13	7.2	0.44	Class-A, Amplifier	125	-9.0	125	3.2/8	37.5/40	17000	6100	—	2700	1.9	7A5
7A6	Twin Diode	7AJ	7.0	0.16	—	—	—	Rectifier	—	—	—	—	—	—	—	—	—	—	7A6
7A7	Remote Cut-off Pentode	8V	7.0	0.32	6	7	.005	Class-A Amplifier	250	-3.0	100	2.0	8.6	800000	2000	—	—	—	7A7
7A8	Multigrad Converter	8U	7.0	0.16	7.5	9.0	0.15	Converter	250	-3.0	100	3.1	3.0	50000	—	—	—	—	7A8
7AD7	Pentode	8V	6.3	0.6	11.5	7.5	0.03	Class-A Amp.	300	68*	150	7.0	28.0	300000	9500	—	—	—	7AD7
7AF7	Twin Triode	8AC	6.3	0.3	2.2	1.6	2.3	Class-A Amp.	250	-10	—	—	9.0	7600	2100	—	—	—	7AF7
7AG7	Sharp Cut-off Pentode	8V	7.0	0.16	7.0	6.0	0.005	Class-A Amp.	250	250*	250	2.0	6.0	750000	4200	—	—	—	7AG7
7AH7	Pentode Amplifier	8V	6.3	0.15	7.0	6.5	0.005	Class-A, Amplifier	250	250*	250	1.9	6.8	1000000	3300	—	—	—	7AH7
7B4	High- $\mu$ Triode	5AC	7.0	0.32	3.6	3.4	1.6	Class-A, Amplifier	250	-2.0	—	—	0.9	66000	1500	—	—	—	7B4
7B5	Pentode Power Amplifier	6A	7.0	0.43	3.2	3.2	1.6	Class-A, Amplifier	250	-18.0	250	5.5/10	37/33	68000	2300	—	—	—	7B5
7B6	Duo-Diode Triode	8W	7.0	0.32	3.0	2.4	1.6	Class-A, Amplifier	250	-2.0	—	—	1.0	91000	1100	—	—	—	7B6
7B7	Remote Cut-off Pentode	8V	7.0	0.16	5	7	.005	Class-A Amplifier	250	-3.0	100	2.0	8.5	700000	1700	—	—	—	7B7
7B8	Tetragrid Converter	8X	7.0	0.32	10.0	9.0	0.2	Converter	250	-3.0	100	2.7	3.5	360000	—	—	—	—	7B8
7C5	Pentode Power Amplifier	6AA	7.0	0.48	9.5	9.0	0.4	Class-A, Amplifier	250	-12.5	250	4.5/7	45/47	52000	4100	—	5000	4.5	7C5
7C6	Duo-Diode Triode	8W	7.0	0.16	2.4	3	1.4	Class-A, Amplifier	250	-1.0	—	—	1.3	100000	1000	—	—	—	7C6
7C7	Pentode Amplifier	8V	7.0	0.16	5.5	6.5	.007	Class-A Amplifier	250	-3.0	100	0.5	2.0	2 meg.	1300	—	—	—	7C7
7D7	Triode-Hexode Converter	8AR	7.0	0.48	—	—	—	Converter	250	-3.0	—	—	—	—	—	—	—	—	7D7

\* Cathode resistor-ohms. <sup>1</sup> Per plate. <sup>2</sup> Screen tied to plate. <sup>3</sup> Through 70,000-ohm dropping resistor. <sup>4</sup> Values are for single tube. <sup>5</sup> Values are for two tubes in push-pull. <sup>6</sup> Plate-to-plate value. <sup>7</sup> No. 1 triode. <sup>8</sup> No. 2 triode. <sup>9</sup> Peak a.f. volts G-G. <sup>10</sup> Discontinued.

Courtesy ARRL Handbook





RECEIVING TUBE SUBSTITUTION GUIDE

TABLE IV—6.3-VOLT GLASS RECEIVING TUBES—Continued

Type	Name	Base	Socket Connections	Fil. or Heater		Capacitance $\mu\text{fd.}$			Use	Plate Supply Volts	Grid Bias	Screen Volts	Screen Current Ma.	Plate Current Ma.	Plate Resistance Ohms	Transcon-ductance Micromhos	Amp. Factor	Lead Resistance Ohms	Power Output Watts	Type
				Volts	Amp.	In	Out	Plate-Grid												
6B7	Duplex-Diode Pentode	S.	7D	6.3	0.3	3.5	9.5	.007	Pentode R.F. Amp.	250	-3.0	125	2.3	9.0	650000	1125	730	—	6B7	
6C6	Sharp Cut-off Pentode	S.	6F	6.3	0.3	5	6.5	.007	R.F. Amplifier	250	-3.0	100	0.5	2.0	1500000	1225	1500	—	6C6	
6C7	Duplex Diode Triode	S.	7G	6.3	0.3	—	—	—	Class-A Amp.	250	-9.0	—	—	4.5	—	20	1250	—	6C7	
6D6	Variable- $\mu$ Pentode	S.	6F	6.3	0.3	4.7	6.5	.007	R.F. Amplifier	250	-3.0	100	2.0	8.2	800000	1600	1280	—	6D6	
6D7	Sharp Cut-off Pentode	S.	7H	6.3	0.3	5.2	6.8	.01	Class-A Amp.	250	-3.0	100	0.5	2.0	—	1600	1280	—	6D7	
6E5	Electron-Ray Tube	S.	6R	6.3	0.3	—	—	—	Indicator Tube	250	0	—	—	0.25	—	Target Current 4 ma.	—	—	6E5	
6E6	Twin Triode Amplifier	M.	7B	6.3	0.6	—	—	—	Class-A Amp.	250	-27.5	—	—	18.0	3500	1700	14000	1.6	6E6	
6E7	Variable- $\mu$ Pentode	S.	7H	6.3	0.3	—	—	—	R.F. Amplifier	250	-3.0	—	—	3.5	16000	500	8	—	6E7	
6F7	Triode Pentode	S.	7E	6.3	0.3	—	—	—	Triode Unit Amp. Pentode Unit Amplifier	100	-3.0	100	1.5	6.5	850000	1100	900	—	6F7	
6U5/6G5	Electron-Ray Tube	S.	6R	6.3	0.3	—	—	—	Indicator Tube	250	Cut-off Grid Bias = -22 v. Cut-off Grid Bias = -8 v.	—	—	0.24	—	Target Current 4 ma. Target Current 1 ma.	—	—	6U5/6G5	
6H5	Electron-Ray Tube	S.	6R	6.3	0.3	—	—	—	Indicator Tube	250	—	—	—	0.24	—	Target Current 4 ma.	—	—	6H5	
36	Tetrode R.F. Amplifier	S.	5E	6.3	0.3	3.8	9	.007	R.F. Amplifier	250	-3.0	90	1.7	3.2	550000	1080	595	—	36	
37	Triode Detector Amplifier	S.	5A	6.3	0.3	3.5	2.9	2	Class-A Amp.	250	-18.0	—	—	7.5	8400	1100	9.2	—	37	
38	Pentode Power Amplifier	S.	5F	6.3	0.3	3.5	7.5	0.3	Class-A Amp.	250	-25.0	250	3.8	22.0	100000	1200	120	10000	2.5	38
39/44	Remote Cut-off Pentode	S.	5F	6.3	0.3	3.8	10	.007	R.F. Amplifier	250	-3.0	90	1.4	5.8	1000000	1050	1050	—	39/44	
41	Pentode Power Amplifier	S.	6B	6.3	0.4	—	—	—	Class-A Amp.	250	-18.0	250	5.5	32.0	68000	2200	150	7600	3.4	41
42	Pentode Power Amplifier	M.	6B	6.3	0.7	—	—	—	Class-A Amp.	250	-16.5	250	6.5	34.0	100000	2200	220	7000	3.0	42
52	Dual Grid Triode	M.	5C	6.3	0.3	—	—	—	Class-B, 2 tubes <sup>5</sup> Class-A Amp.	110	0	—	—	43.0	1750	3000	5.2	2000	1.5	52
56A5	Triode Amplifier	S.	5A	6.3	0.4	—	—	—	Class-A Amp.	180	0	—	—	3.0	—	—	10000	5.0	56A5	
57A5	Sharp Cut-off Pentode	S.	6F	6.3	0.4	—	—	—	R.F. Amplifier	—	—	—	—	—	—	—	—	—	57A5	
58A5	Remote Cut-off Pentode	S.	6F	6.3	0.4	—	—	—	R.F. Amplifier	—	—	—	—	—	—	—	—	—	58A5	
75	Duplex-Diode Triode	S.	6G	6.3	0.3	1.7	3.8	1.	Triode Amplifier	250	-1.35	—	—	0.4	91000	1100	100	—	75	
76	Triode Detector Amplifier	S.	5A	6.3	0.3	3.5	2.5	2.8	Class-A Amp.	250	-13.5	—	—	5.0	9500	1450	13.8	—	76	
77	Sharp Cut-off Pentode	S.	6F	6.3	0.3	4.7	11	.007	R.F. Amplifier	250	-3.0	100	0.5	2.3	1500000	1250	1500	—	77	
79	Variable- $\mu$ Pentode	S.	6F	6.3	0.3	4.5	11	.007	R.F. Amplifier	250	-3.0	100	1.7	7.0	800000	1450	1160	—	79	
85	Twin Triode Amplifier	S.	6H	6.3	0.6	—	—	—	Class-B Amp.	250	0	—	—	10.6 <sup>12</sup>	Power output is for one tube	14000	8.0	8.0	79	
85A5	Duplex-Diode Triode	S.	6G	6.3	0.3	1.5	4.3	1.5	Class-A Amp.	250	-20.0	—	—	8.0	7500	1100	8.3	20000	0.35	85
89	Power Amplifier Pentode	S.	6G	6.3	0.3	—	—	—	Class-A Amp. <sup>8</sup> Triode Amp. <sup>2</sup>	250	-9.0	—	—	5.5	—	1250	20	—	85A5	
1221	Pentode R.F. Amplifier	S.	6F	6.3	0.3	—	—	—	Class-A Amp.	250	-31.0	—	—	32.0	2600	1800	4.7	5500	0.9	1221
1603 <sup>3</sup>	Sharp Cut-off Pentode	M.	6F	6.3	0.3	—	—	—	Class-A Amp.	250	-25.0	250	5.5	32.0	70000	1800	125	6750	3.4	1603
7700 <sup>3</sup>	Sharp Cut-off Pentode	S.	6F	6.3	0.3	—	—	—	Class-A Amp.	250	-25.0	250	5.5	32.0	70000	1800	125	6750	3.4	7700

\* Cathode bias resistor—ohms.  
<sup>1</sup> Current to input plate (P1).  
<sup>2</sup> Grids Nos. 2 and 3 connected to plate.  
<sup>3</sup> Discontinued.  
<sup>4</sup> G<sub>2</sub> tied to plate.  
<sup>5</sup> G<sub>1</sub> tied to G<sub>2</sub>.  
<sup>6</sup> Osc. grid leak ohms.  
<sup>7</sup> Screen dropping resistor ohms.  
<sup>8</sup> Grid No. 2, screen; grid No. 3, suppressor.  
<sup>9</sup> Values for single tube.  
<sup>10</sup> Values for two tubes in push-pull.  
<sup>11</sup> Plate-to-plate value.  
<sup>12</sup> No signal value.

Courtesy ARRL Handbook

RECEIVING TUBE SUBSTITUTION GUIDE

TABLE V—2.5-VOLT RECEIVING TUBES

Type	Name	Base	Socket Connections	Fil. or Heater		Capacitance $\mu$ fd.			Use	Plate Supply Volts	Grid Bias	Screen Volts	Screen Current Ma.	Plate Current Ma.	Plate Resistance Ohms	Transcon-ductance Micromhos	Amp. Factor	Load Resistance Ohms	Power Output Watts	Type
				Volts	Amp.	In	Out	Plate-Grid												
25/4S	Duodiode	M.	5D	2.5	1.35	—	—	—	Detector	250	—	—	—	—	—	—	—	—	25/4S	
2A3	Triode Power Amplifier	M.	4D	2.5	2.5	7.5	5.5	16.5	Class-A Amp.	250	—	—	—	—	—	—	—	—	2A3	
2A5	Pentode Power Amplifier	M.	6B	2.5	1.75	—	—	—	Class-A Amp.	250	—	—	—	—	—	—	—	—	2A5	
2A6	Duplex-Diode Triode	S.	6G	2.5	0.8	1.7	3.8	1.7	Class-A Amp.	250	—	—	—	—	—	—	—	—	2A6	
2A7	Pentagrid Converter	S.	7C	2.5	0.8	—	—	—	Converter	250	-24.0	—	—	—	—	—	—	—	2A7	
2B6	Direct-Coupled Amplifier	M.	7J	2.5	2.25	—	—	—	Amplifier	250	—	—	—	—	—	—	—	—	2B6	
2B7	Duplex-Diode Pentode	S.	7D	2.5	0.8	3.5	9.5	.007	Pentode Amp.	250	—	—	—	—	—	—	—	—	2B7	
2E5	Electron-Ray Tube	S.	6R	2.5	0.8	—	—	—	Indicator Tube	250	—	—	—	—	—	—	—	—	2E5	
2G5	Electron-Ray Tube	S.	6R	2.5	0.8	—	—	—	Indicator Tube	250	—	—	—	—	—	—	—	—	2G5	
24-A	Tetrode R.F. Amplifier	M.	5E	2.5	1.75	5.3	10.5	.007	Screen-Grid R.F. Amplifier	250	-3.0	90	1.7	4.0	600000	1050	630	—	24-A	
27	Triode Detector-Amplifier	M.	5A	2.5	1.75	3.1	2.3	3.3	Class-A Amp.	250	-5.0	20/45	—	—	—	—	—	—	27	
35/51	Remote Cut-off Pentode	M.	5E	2.5	1.75	5.3	10.5	.007	Screen-Grid R.F. Amplifier	250	-3.0	90	2.5	6.5	400000	1050	420	—	35/51	
45	Triode Power Amplifier	M.	4D	2.5	1.5	4	3	7	Class-A Amp.	275	-36.0	—	—	—	—	—	—	—	45	
46	Dual-Grid Power Amp.	M.	5C	2.5	1.75	—	—	—	Class-A Amp.	250	-33.0	—	—	—	—	—	—	—	46	
47	Pentode Power Amplifier	M.	5B	2.5	1.75	8.6	13	1.2	Class-B Amp.	400	0	—	—	—	—	—	—	—	47	
53	Twin Triode Amplifier	M.	7B	2.5	2.0	—	—	—	Class-B Amp.	250	-16.5	250	6.0	31.0	60000	2300	150	7000	2.7	47
55	Duplex-Diode Triode	S.	6G	2.5	1.0	1.5	4.3	1.5	Class-A Amp.	250	—	—	—	—	—	—	—	—	53	
56	Triode Amplifier, Detector	S.	5A	2.5	1.0	3.2	2.4	3.2	Class-A Amp.	250	—	—	—	—	—	—	—	—	56	
57	Sharp Cut-off Pentode	S.	6F	2.5	1.0	—	—	—	Screen-Grid R.F. Amplifier	250	-3.0	100	0.5	2.0	1500000	1225	1500	—	57	
58	Remote Cut-off Pentode	S.	6F	2.5	1.0	4.7	6.3	.007	Screen-Grid R.F. Amplifier	250	-3.0	100	2.0	8.2	800000	1600	1280	—	58	
59	Pentode Power Amplifier	M.	7A	2.5	2.0	—	—	—	Class-A Triode	250	-28.0	—	—	—	—	—	—	—	59	
RK15	Triode Power Amplifier	M.	4D <sup>1</sup>	2.5	1.75	—	—	—	Class-A Triode	250	-18.0	250	9.0	35.0	40000	2600	100	6000	3.0	RK15
RK16	Triode Power Amplifier	M.	5A	2.5	2.0	—	—	—	Class-A Triode	250	—	—	—	—	—	—	—	—	RK16	
RK17	Pentode Power Amplifier	M.	5F	2.5	2.0	—	—	—	Class-A Triode	250	—	—	—	—	—	—	—	—	RK17	

<sup>1</sup> Grid connection to cap; no connection to No. 3 pin. <sup>2</sup> Grid No. 2 tied to plate. <sup>3</sup> Grids Nos. 1 and 2 tied together. <sup>4</sup> Grids Nos. 2 and 3 connected to plate. <sup>5</sup> Grid No. 2, screen; grid No. 3, suppressor.

TABLE VI—2.0-VOLT BATTERY RECEIVING TUBES

Type	Name	Base	Socket Connections	Filament		Capacitance $\mu$ fd.			Use	Plate Supply Volts	Grid Bias	Screen Volts	Screen Current Ma.	Plate Current Ma.	Plate Resistance Ohms	Transcon-ductance Micromhos	Amp. Factor	Load Resistance Ohms	Power Output Watts	Type
				Volts	Amp.	In	Out	Plate-Grid												
1A4P	Variable- $\mu$ Pentode	S.	4M	2.0	0.06	5	11	.007	R.F. Amplifier	180	-3.0	67.5	0.8	2.3	1000000	750	750	—	—	1A4P
1A4T	Variable- $\mu$ Tetrode	S.	4K	2.0	0.06	5	11	.007	R.F. Amplifier	180	-3.0	67.5	0.7	2.3	900000	750	720	—	—	1A4T
1A6	Pentagrid Converter	S.	6L	2.0	0.06	—	—	—	Converter	180	-3.0	67.5	2.4	1.3	500000	Anode grid (No. 2)	180 max. volts	—	—	1A6
1B4P/951	Pentode R.F. Amplifier	S.	4M	2.0	0.06	5	11	.007	R.F. Amplifier	180	-3.0	67.5	0.6	1.7	1500000	650	1000	—	—	1B4P/951
1B5/255	Duplex-Diode Triode	S.	6M	2.0	0.06	1.6	1.9	3.6	Triode Class-A	135	-3.0	—	—	0.8	35000	575	20	—	—	1B5/255

Courtesy ARRL Handbook

RECEIVING TUBE SUBSTITUTION GUIDE

TABLE VI—2.0-VOLT BATTERY RECEIVING TUBES—Continued

Type	Name	Base Connec-tions	Socket Connec-tions	Filament		Capacitance $\mu$ fd.		Use	Plate Supply Volts	Grid Bias	Screen Volts	Screen Current Ma.	Plate Current Ma.	Plate Resistance Ohms	Transcon-ductance Micromhos	Amp. Factor	Load Resistance Ohms	Power Output Watts	Type
				Volts	Amp.	In	Out												
1C6	Pentagrid Converter	S, 6L	6L	2.0	0.12	10	10	Converter	180	-3.0	67.5	2.0	1.5	750000	Anode grid (No. 2) 135 max. volts	340	135000	0.34	1C6
1F4	Pentode Power Amplifier	M, 5K	5K	2.0	0.12	—	—	Class-A Amp.	135	-4.5	135	2.6	8.0	200000	1700	340	16000	0.34	1F4
1F6	Duplex-Diode Pentode	S, 6W	6W	2.0	0.06	4	9	R.F. Amplifier	180	-1.5	67.5	0.6	2.0	1000000	650	650	—	—	1F6
15 $\frac{1}{2}$	Sharp Cut-off Pentode	S, 5F	5F	2.0	0.22	2.3	7.8	R.F. Amplifier	135	-1.5	67.5	0.3	1.85	800000	750	600	Amp. =48	—	15
19	Twin-Triode Amplifier	S, 6C	6C	2.0	0.26	—	—	Class-B Amp.	135	0	—	—	—	Load plate-to-plate	10000	10000	2.1	19	
30	Triode Detector Amplifier	S, 4D	4D	2.0	0.06	—	—	Class-A Amp.	180	-13.5	—	—	3.1	10300	900	9.3	—	—	30
31	Triode Power Amplifier	S, 4D	4D	2.0	0.13	3.5	2.7	Class-A Amp.	180	-30.0	—	—	12.3	3600	1050	3.8	5700	0.375	31
32	Sharp Cut-off Pentode	M, 4K	4K	2.0	0.06	5.3	10.5	R.F. Amplifier	180	-3.0	67.5	0.4	1.7	1200000	650	780	—	—	32
33	Pentode Power Amplifier	M, 5K	5K	2.0	0.26	8	12	Class-A Amp.	180	-18.0	180	5.0	22.0	55000	1700	90	6000	1.4	33
34	Variable- $\mu$ Pentode	M, 4M	4M	2.0	0.06	6	11	R.F. Amplifier	180	-3.0	67.5	1.0	2.8	1000000	620	620	—	—	34
49	Dual-Grid Power Amp.	M, 5C	5C	2.0	0.12	—	—	Class-A Amp. <sup>1</sup>	135	-20.0	—	—	6.0	4175	1125	4.7	11000	0.17	49
840	Pentode	S, 5J	5J	2.0	0.13	—	—	Class-B Amp. <sup>2</sup>	180	0	—	—	—	Power output for 2 tubes	400	400	—	—	840
950	Pentode Power Amplifier	M, 5K	5K	2.0	0.12	—	—	Class-A Amp.	180	-3.0	67.5	0.7	1.0	1000000	400	400	—	—	950
RK24	Triode	M, 4D	4D	2.0	0.12	—	—	Class-A Amp.	135	-16.5	135	2.0	7.0	10000	1000	125	13500	0.575	950
1229	Tetode	M, 4K	4K	2.0	0.06	—	—	Class-A Amp.	180	-13.5	—	—	8.0	5000	1600	8.0	12000	0.25	RK24
1230	Triode	M, 4D	4D	2.0	0.06	3.0	2.1	—	180	-13.5	—	—	8.0	5000	1600	8.0	12000	0.25	1229
																			1230

<sup>1</sup> Grid No. 2 tied to plate.

<sup>2</sup> Grids Nos. 1 and 2 tied together.

TABLE VII—2.0-VOLT BATTERY TUBES WITH OCTAL BASES

Type	Name	Socket Connec-tions	Filament		Capacitance $\mu$ fd.		Use	Plate Supply Volts	Grid Bias	Screen Volts	Screen Current Ma.	Plate Current Ma.	Plate Resistance Ohms	Transcon-ductance Micromhos	Amp. Factor	Load Resistance Ohms	Power Output Watts	Type	
			Volts	Amp.	In	Out													Plate-Grid
1C7G	Heptode	7Z	2.0	0.06	10	14	0.26	Converter	180	-3.0	67.5	0.7	2.2	600000	650	—	—	—	1C7G
1D5GP	Variable- $\mu$ Pentode	5Y	2.0	0.06	5	11	.007	R.F. Amplifier	180	-3.0	67.5	0.7	2.2	600000	650	—	—	—	1D5GP
1D5GT <sup>1</sup>	Variable- $\mu$ Tetode	5R	2.0	0.06	—	—	—	R.F. Amplifier	180	-3.0	67.5	0.7	2.2	600000	650	—	—	—	1D5GT
1D7G	Pentagrid Converter	7Z	2.0	0.06	10.5	9.0	0.25	Converter	180	-3.0	67.5	0.7	2.2	600000	650	—	—	—	1D7G
1E5GP	Pentode Amplifier	5Y	2.0	0.06	5	11	.007	R.F. Amplifier	180	-3.0	67.5	0.7	2.2	600000	650	—	—	—	1E5GP
1E7G	Double Pentode Power Amp.	8C	2.0	0.24	—	—	—	Class-A Amplifier	135	-7.5	135	2.0	6.5	220000	1600	350	24000	0.65	1E7G
1F5G	Pentode Power Amplifier	6X	2.0	0.12	—	—	—	Class-A Amplifier	135	-13.5	135	2.5	8.7	160000	1550	250	9000	0.55	1F5G
1F7G <sup>2</sup>	Duplex-Triode Pentode	7AD	2.0	0.12	3.8	9.5	0.01	Detector-Amplifier	135	-13.5	135	2.5	8.7	160000	1550	250	9000	0.55	1F7G
1G5G	Pentode Power Amplifier	6X	2.0	0.12	—	—	—	Class-A Amplifier	135	-16.5	135	2.0	7.0	—	—	—	—	—	1G5G
1H4G	Triode Amplifier	5S	2.0	0.06	—	—	—	Detector-Amplifier	135	-16.5	135	2.0	7.0	—	—	—	—	—	1H4G
1H6G	Duplex-Diode Triode	7AA	2.0	0.06	1.6	1.9	3.6	Detector-Amplifier	135	-16.5	135	2.0	7.0	—	—	—	—	—	1H6G
1J5G <sup>1</sup>	Pentode Power Amplifier	6X	2.0	0.12	—	—	—	Class-A Amplifier	90	-1.5	—	—	1.1	26600	750	20	8000	1.0	1J5G
1J6G	Twin Triode	7AB	2.0	0.24	—	—	—	Class-B Amplifier	90	-1.5	—	—	1.1	26600	750	20	8000	1.0	1J6G
4A6G	Twin Triode	8L	4.0	0.12	—	—	—	Class-A, 1 section	90	-1.5	—	—	10.8	—	—	—	—	—	4A6G
			4.0	0.06	—	—	—	Class-B, 2 sections	90	-1.5	—	—	10.8	—	—	—	—	—	

<sup>1</sup> Discontinued.

<sup>2</sup> Total current for both sections; no signal.

<sup>3</sup> Type GV has 7AF base.

<sup>4</sup> Max. signal.

Courtesy ARRL Handbook

RECEIVING TUBE SUBSTITUTION GUIDE

TABLE VIII—1.5-VOLT FILAMENT BATTERY TUBES

See also Table X for Special 1.4-volt Tubes

Type	Name	Base	Socket Connections	Filament		Capacitance $\mu\text{ufd.}$		Plate-Grid	Use	Plate Supply Volts	Grid Bias	Screen Volts	Screen Current Ma.	Screen Current Ma.	Plate Current Ma.	Plate Resistance Ohms	Transconductance Micromhos	Amp. Factor	Lead Resistance Ohms	Power Output M-watts	Type
				Volts	Amp.	In	Out														
1A5GT	Pentode Power Amplifier	O	6X	1.4	0.05	—	—	—	Class-A Amp.	90	-4.5	90	0.6	0.55	300000	850	240	25000	115	1A5GT	
1A7GT	Pentagrid Converter	O	7Z	1.4	0.05	—	—	—	Converter	90	0	45	0.6	0.55	600000	—	—	—	—	1A7GT	
1AB5	Pentode R.F. Amplifier	L	5BF	1.2	0.05	2.8	4.2	0.25	R.F. Amplifier	90	0	90	0.8	3.5	275000	1100	—	—	—	1AB5	
1B7GT #	Heptode	O	7Z	1.4	0.1	—	—	—	Converter	90	0	45	1.3	1.5	350000	Grid No. 1 resistor 200,000 ohms	—	—	—	1B7GT	
1B8GT	Diode Triode Pentode	O	8AW	1.4	0.1	—	—	—	Triode Amplifier Pentode Amp.	90	-6.0	90	—	0.15	240000	275	—	14000	210	1B8GT	
1C5GT	Pentode Power Amplifier	O	6X	1.4	0.1	—	—	—	Class-A Amp.	90	-7.5	90	1.6	7.5	115000	1550	165	8000	240	1C5GT	
1D8GT	Diode Triode Pentode	O	8AJ	1.4	0.1	—	—	—	Triode Amp. Pentode Amp.	90	0	90	1.0	5.0	43500	575	25	—	—	1D8GT	
1E4G	Triode Amplifier	O	55	1.4	0.05	2.4	6	2.40	Class-A Amp.	90	-3.0	—	—	4.5	11000	1325	14.5	—	—	1E4G	
1G4GT	Triode Amplifier	O	55	1.4	0.05	2.2	3.4	2.80	Class-A Amp.	90	-6.0	—	—	1.5	17000	825	14	—	—	1G4GT	
1G6GT	Twin Triode	O	7AB	1.4	0.1	—	—	—	Class-A Amp.	90	0	—	—	2.3	10700	825	8.8	—	—	1G6GT	
1H5GT	Diode High- $\mu$ Triode	O	5Z	1.4	0.05	1.1	6	1.00	Class-A Amp.	90	0	—	—	1/7	45000	675	30	—	—	1H5GT	
1LA4	Pentode Power Amplifier	L	5AD	1.4	0.05	—	—	—	Class-A Amp.	90	0	45	0.6	0.55	200000	975	—	—	—	1LA4	
1LB4	Pentode Power Amplifier	L	7AK	1.4	0.05	—	—	—	Class-A Amp.	90	-9	90	1.0	5.0	200000	975	—	12000	200	1LB4	
1LB6	Heptode Converter	L	8AX	1.4	0.05	—	—	—	Converter	90	0	67.5	2.2	0.4	Grid No. 4—67.5 v., No. 5—0 v.	—	—	—	—	—	1LB6
1LC5	Remote Cut-off Pentode	L	7AO	1.4	0.05	3.2	7	.007	R.F. Amplifier	90	0	45	0.2	1.15	1500000	775	—	—	—	1LC5	
1LC6	Pentagrid Converter	L	7AK	1.4	0.05	—	—	—	Converter	90	0	35	0.7	0.75	—	—	—	—	—	1LC6	
1LD5	Diode Pentode	L	6AX	1.4	0.05	3.2	6	0.18	Class-A Amp.	90	0	45	0.1	0.6	950000	600	—	—	—	1LD5	
1LE3	Triode Amplifier	L	4AA	1.4	0.05	1.7	3	1.70	Class-A Amp.	90	-3	—	—	4.5	11200	1300	14.5	—	—	1LE3	
1LG5	Pentode R.F. Amp.	L	7AO	1.4	0.05	—	—	—	Class-A Amp.	90	0	45	0.4	1.7	1000000	800	—	—	—	1LG5	
1LH4	Diode High- $\mu$ Triode	L	5AG	1.4	0.05	1.1	6	1.00	Class-A Amp.	90	0	—	—	0.15	240000	275	65	—	—	1LH4	
1LN5	Remote Cut-off Pentode	L	7AO	1.4	0.05	3.4	8	.007	Class-A Amp.	90	0	90	0.3	1.2	1500000	750	—	—	—	1LN5	
1N5GT	Remote Cut-off Pentode	O	5Y	1.4	0.05	3	10	.007	Class-A Amp.	90	0	90	0.3	1.2	1500000	750	1160	—	—	1N5GT	
1N6G †	Diode-Power-Pentode	O	7AM	1.4	0.05	—	—	—	Class-A Amp.	90	-4.5	90	0.6	3.1	300000	800	—	25000	100	1N6G	
1P5GT	Pentode	O	5Y	1.4	0.05	3	10	.007	R.F. Amplifier	90	0	90	0.7	2.3	800000	800	640	—	—	1P5GT	
1Q5GT	Tetode Power Amplifier	O	6AF	1.4	0.1	—	—	—	Class-A Amp.	85	-5.0	85	1.2	7.2	70000	1950	—	9000	250	1Q5GT	
1R4/1294	U.h.f. Diode	L	4AH	1.4	0.15	—	—	—	Rectifier	90	0	67.5	0.68	2.45	800000	970	—	—	—	1R4/1294	
1SA6GT	Medium Cut-off Pentode	O	6CA	1.4	0.05	5.2	8.6	0.01	R.F. Amplifier	90	0	67.5	1.038	1.45	700000	665	—	—	—	1SA6GT	
1SB6GT	Diode Pentode	O	6CB	1.4	0.05	3.2	3	0.25	Class-A Amp.	90	0	90	—	—	—	—	—	—	—	1SB6GT	
1T5GT	Beam Power Amplifier	O	6AF	1.4	0.05	4.8	8	0.50	R.C. Amplifier	90	0	90	1.4	6.5	Screen resistor 5 meg., grid 10 meg.	—	—	1 meg.	110	1T5GT	
3B7/1291	U.h.f. Twin Triode	L	7BE	2.8	0.11	1.4	2.6	2.6	Class-A Amp.	90	-6.0	90	—	—	—	—	—	—	—	3B7/1291	
1293	U.h.f. Triode	L	4AA	1.4	0.11	1.7	3.0	1.7	Class-A Amp.	90	0	—	—	5.2	11350	1850	21	—	—	1293	
3D6/1299	U.h.f. Tetode	L	6BB	2.8	0.11	7.5	6.5	0.30	Class-A Amp.	135	-6	90	0.7	5.7	10750	1300	14	—	—	3D6/1299	
3E6	R.F. Pentode	L	7CJ	1.4	0.10	5.5	7.5	0.007	Class-A Amp.	90	0	90	1.3	3.8	300000	2100	—	—	—	3E6	
RK42	Triode Amplifier	S	4D	1.5	0.6	—	—	—	Class-A Amp.	—	—	—	—	—	—	—	—	—	—	RK42	
RK43	Twin Triode Amplifier	S	6C	1.5	0.12	—	—	—	Class-A Amp.	135	-3	—	—	4.5	14500	900	13	—	—	RK43	

# Discontinued.

† Through series resistor. Screen voltage must be at least 10 volts lower than oscillator anode.

‡ Voltage gain.

§ Center-top filament permits 1.4-volt operation.

Courtesy ARRL Handbook



RECEIVING TUBE SUBSTITUTION GUIDE

TABLE IX—HIGH-VOLTAGE HEATER TUBES

Type	Name	Base	Socket Connections	Heater		Capacitance $\mu\mu\text{fd.}$			Plate-Grid	Use	Plate Supply Volts	Grid Bias	Screen Volts	Screen Current Ma.	Screen Current Ma.	Plate Current Ma.	Plate Resistance Ohms	Transconductance Micromhos	Amp. Factor	Load Resistance Ohms	Power Output Watts	Type
				Volts	Amp.	In	Out	In														
12A5	Pentode Power Amplifier	M.	7F	12.6	0.3	9.0	9.0	0.3	Class-A; Amp. <sup>6</sup>	100	-15	100	3/5.5	17/19	50000	1700	—	—	4500	0.8	12A5	
12A6	Beam Power Amplifier	O.	7AC	12.6	0.6	—	—	—	Class-A Amp.	180	-25	180	8/14	45/48	35000	2400	—	—	3300	3.4	12A6	
12A7	Rectifier-Amplifier	M.	7K	12.6	0.3	—	—	—	Class-A Amp.	250	-12.5	250	3.5	30	70000	3000	—	—	7500	3.4	12A7	
12A8GT	Heptode	O.	8A	12.6	0.3	9.3	12	0.26	Converter	135	-13.5	135	2.5	9.0	102000	975	—	—	13500	0.55	12A8GT	
12AH7GT	Twin Triode	O.	8BE	12.6	0.15	Each	Triode Sect.	—	Class-A Amp.	180	-6.5	—	—	—	8400	1900	—	—	—	—	12AH7GT	
12B6M	Diode Triode	O.	6Y	12.6	0.15	—	—	—	Class-A Amp.	250	-2.0	—	—	—	91000	1100	—	—	—	—	12B6M	
12B7M1	Pentode Amplifier	O.	8V	12.6	0.15	—	—	—	Class-A Amp.	250	-3.0	100	2.6	9.2	800000	2000	—	—	—	—	12B7M1	
12B8GT	Triode-Pentode	O.	8T	12.6	0.3	Triode	Section	—	Class-A Amp.	100	-1	—	—	8	73000	1500	—	—	—	—	12B8GT	
12C8	Duplex-Diode Pentode	O.	8E	12.6	0.15	6	9	.005	Class-A Amp.	250	-13.5	—	—	50	—	1450	—	—	—	—	12C8	
12E5GT	Triode Amplifier	O.	6Q	12.6	0.15	3.4	5.5	2.60	Class-A Amp.	250	-2.0	—	—	—	65F5—Table I	—	—	—	—	—	12E5GT	
12F5GT	Triode Amplifier	O.	5M	12.6	0.15	1.9	3.4	2.40	Class-A Amp.	250	-3.0	—	—	—	58000	1200	—	—	—	—	12F5GT	
12G7G	Duplex-Diode Triode	O.	7V	12.6	0.15	—	—	—	Class-A Amp.	250	-3.0	—	—	—	—	—	—	—	—	—	12G7G	
12H6	Twin Diode	O.	7Q	12.6	0.15	—	—	—	Rectifier	—	—	—	—	—	—	—	—	—	—	—	12H6	
12J5GT	Triode Amplifier	O.	6Q	12.6	0.15	3.4	3.6	3.40	Class-A Amp.	—	—	—	—	—	—	—	—	—	—	—	12J5GT	
12J7GT	Sharp Cut-off Pentode	O.	7R	12.6	0.15	4.2	5.0	3.8	Class-A Amp.	—	—	—	—	—	—	—	—	—	—	—	12J7GT	
12K7GT	Remote Cut-off Pentode	O.	7R	12.6	0.15	4.6	12	.005	R.F. Amplifier	100	-1	—	—	—	—	—	—	—	—	—	12K7GT	
12K8	Triode Hexode Converter	O.	8K	12.6	0.15	—	—	—	Converter	180	-9.0	180	2.8	13.0	160000	2150	—	—	10000	1.0	12K8	
12L8GT	Twin Pentode	O.	8BU	12.6	0.15	5	6	0.70	Class-A; Amp.	—	—	—	—	—	—	—	—	—	—	—	12L8GT	
12Q7GT	Duplex-Diode Triode	O.	7V	12.6	0.15	2.2	5	1.60	Class-A Amp.	250	-2.0	—	—	—	—	—	—	—	—	—	12Q7GT	
12S5GT	Triode-Diode Triode	O.	8CB	12.6	0.15	2.0	3.8	1.2	Class-A Amp.	250	-2.0	—	—	—	—	—	—	—	—	—	12S5GT	
12S7A7	Heptode	O.	8R	12.6	0.15	9.5	12	0.13	Converter	—	—	—	—	—	—	—	—	—	—	—	12S7A7	
12S7	Twin Triode	O.	8S	12.6	0.15	2.2	3.0	2.0	Class-A Amp.	—	—	—	—	—	—	—	—	—	—	—	12S7	
12S7F5	High- $\mu$ Triode	O.	6AB	12.6	0.15	4	3.6	2.40	Class-A Amp.	—	—	—	—	—	—	—	—	—	—	—	12S7F5	
12S7F7	Diode Variable- $\mu$ Pentode	O.	7AZ	12.6	0.15	5.5	6.0	.004	Class-A Amp.	—	—	—	—	—	—	—	—	—	—	—	12S7F7	
12S7G7	Medium Cut-off Pentode	O.	8BK	12.6	0.15	8.5	7.0	.003	Class-A Amp.	—	—	—	—	—	—	—	—	—	—	—	12S7G7	
12SH7	Sharp Cut-off Pentode	O.	8BK	12.6	0.15	8.5	7.0	.003	H-F Amplifier	—	—	—	—	—	—	—	—	—	—	—	12SH7	
12S17	Sharp Cut-off Pentode	O.	8N	12.6	0.15	—	—	—	Class-A Amp.	—	—	—	—	—	—	—	—	—	—	—	12S17	
12S17GT	Remote Cut-off Pentode	O.	8N	12.6	0.15	6.0	7.0	.003	R.F. Amplifier	—	—	—	—	—	—	—	—	—	—	—	12S17GT	
12S7GT	Twin Triode	O.	8BD	12.6	0.15	—	—	—	Class-A Amp.	—	—	—	—	—	—	—	—	—	—	—	12S7GT	
12SQ7	Duplex-Diode Triode	O.	8Q	12.6	0.15	3.2	3.0	1.60	Class-A Amp.	—	—	—	—	—	—	—	—	—	—	—	12SQ7	
12SR7	Duplex-Diode Triode	O.	8Q	12.6	0.15	3.6	2.8	2.40	Class-A Amp.	—	—	—	—	—	—	—	—	—	—	—	12SR7	
12SW7	Duplex-Diode Triode	O.	8Q	12.6	0.15	3.0	2.8	2.4	Class-A; Amp.	250	-9	—	—	9.5	8500	1900	—	—	—	—	12SW7	
12SX7	Twin Triode	O.	8BD	12.6	0.3	3.0	0.8	3.6	Class-A; Amp. <sup>3</sup>	250	-8	—	—	9	7700	2600	—	—	—	—	12SX7	
12SY7	Heptode Converter	O.	8R	12.6	0.15	0.1c.	Grid leak	20000 ohms	Converter	250	-2	100	8.5	3.5	1000000	450	—	—	—	—	12SY7	
14A4	Triode Amplifier	L.	5AC	14	0.16	3.4	3.0	4.00	Class-A Amp.	250	-12.5	250	3.5/5.5	30/32	70000	3000	—	—	7500	2.8	14A4	
14A5	Beam Power Amplifier	L.	6AA	14	0.16	—	—	—	Class-A; Amp.	250	-3.0	100	2.6	9.2	800000	2000	—	—	—	—	14A5	
14A7/12B7	Remote Cut-off Pentode	L.	8V	14	0.16	6.0	7.0	.005	Class-A Amp.	250	-3.0	100	2.6	9.2	800000	2000	—	—	—	—	14A7/12B7	
14AF7	Twin Triode	L.	8AC	14	0.16	2.2	1.6	2.30	Class-A Amp.	250	-10	—	—	9	7600	2100	—	—	—	—	14AF7	
1486	Duplex-Diode Triode	L.	8W	14	0.16	—	—	—	Class-A Amp.	—	—	—	—	—	—	—	—	—	—	—	1486	
1488	Pentagrid Converter	L.	8X	14	0.16	1c2=4	Ma.	—	Converter	—	—	—	—	—	—	—	—	—	—	—	1488	
14C5	Beam Power Amplifier	L.	6AA	14	0.24	—	—	—	Class-A Amp.	—	—	—	—	—	—	—	—	—	—	—	14C5	

Courtesy ARRL Handbook

RECEIVING TUBE SUBSTITUTION GUIDE

TABLE IX — HIGH-VOLTAGE HEATER TUBES — Continued

Type	Name	Base	Socket Connections	Heater		Capacitance $\mu\text{fd}$ .			Plate-Grid	Use	Plate Supply Volts	Grid Bias	Screen Volts	Screen Current Ma.	Plate Current Ma.	Plate Resistance Ohms	Transconductance Micromhos	Amp. Factor	Load Resistance Ohms	Power Output Watts	Type
				Volts	Amp.	In	Out	Grid													
14C7	R.F. Pentode	L	8V	14	0.16	6.0	6.5	.007	Class-A Amp.	250	-3.0	100	0.7	2.2	1000000	1375	—	—	—	14C7	
14E6	Duplex-Diode Triode	L	8W	14	0.16	—	—	—	Class-A Amp.	—	—	—	—	—	—	—	—	—	—	14E6	
14E7	Duplex-Diode Pentode	L	8AE	14	0.16	4.6	5.3	.005	Class-A Amp.	—	—	—	—	—	—	—	—	—	—	14E7	
14F7	Twin Triode	L	8AC	14	0.16	—	—	—	Class-A Amp.	—	—	—	—	—	—	—	—	—	—	14F7	
14F8	Twin Triode	L	8BW	12.6	0.15	2.8	1.4	1.2	Class-A1 Amp.	—	—	—	—	—	—	—	—	—	—	14F8	
14H7	Semi-Variable- $\mu$ Pentode	L	8V	14	0.16	8.0	7.0	.007	Class-A Amp.	250	-2.5	150	3.5	9.5	800000	3800	—	—	—	14H7	
14J7	Triode-Hexode Converter	L	8BL	14	0.16	—	—	—	Converter	—	—	—	—	—	—	—	—	—	—	14J7	
14N7	Twin Triode	L	8AC	14	0.32	—	—	—	Class-A Amp.	—	—	—	—	—	—	—	—	—	—	14N7	
14Q7	Heptode Pentagrid Converter	L	8AL	14	0.16	—	—	—	Converter	—	—	—	—	—	—	—	—	—	—	14Q7	
14R7	Duplex-Diode Pentode	L	8AE	14	0.16	5.6	5.3	.004	Class-A Amp.	250	-2.0	100	3	1.8	1250000	525	—	—	—	14R7	
14S7	Triode Heptode	L	8BL	14	0.16	—	—	—	Converter	300	-2.0	150	3.9	9.6	300000	5800	—	—	—	14S7	
14V7	H.F. Pentode	L	8V	14	0.24	—	—	—	Class-A Amp.	300	-2.2	150	3.9	10	300000	5800	—	—	—	14V7	
14W7	Pentode	L	8BL	14	0.24	—	—	—	Class-A Amp.	300	-2.2	150	3.9	10	300000	5800	—	—	—	14W7	
18	Pentode	M	6B	14	0.30	—	—	—	Class-A Amp.	—	—	—	—	—	—	—	—	—	—	18	
198G6G	Beam Power Amp.	O	8BT	18.9	0.3	11	6.5	0.65	Deflection Amp.	400	-3.0	100	3.4	1.5	—	—	—	—	—	198G6G	
20J8GM	Triode Heptode Converter	O	8H	20	0.15	—	—	—	Converter	250	-3.0	100	2.8	1.3	—	—	—	—	—	20J8GM	
21A7	Triode Hexode Converter	L	8AR	21	0.16	—	—	—	Converter	250	-3.0	100	2.8	1.3	—	—	—	—	—	21A7	
25A6	Pentode Power Amplifier	O	7S	25	0.3	8.5	12.5	0.20	Class-A Amp.	135	-20.0	135	8	37	35000	2450	85	4000	2.0	25A6	
25A7GT	Rectifier Power Pentode	O	8F	25	0.3	—	—	—	Class-A Amp.	100	-15.0	100	4	20.5	50000	1800	90	4500	0.77	25A7GT	
25AC5GT	Triode Power Amplifier	O	6Q	25	0.3	—	—	—	Class-A Amp.	110	+15.0	—	—	—	—	—	—	—	—	25AC5GT	
25B5	Direct-Coupled Triodes	S	6D	25	0.3	—	—	—	Class-A Amp.	110	0	110	7	45	11400	2200	25	2000	2.0	25B5	
25B6G	Pentode Power Amplifier	O	7S	25	0.3	—	—	—	Class-A Amp.	95	-15.0	95	4	45	—	—	—	—	—	25B6G	
25B8GT	Triode Pentode	O	8T	25	0.15	—	—	—	Class-A Amp.	—	—	—	—	—	—	—	—	—	—	25B8GT	
25BQ6GT	Beam Pentode	O	6AM	25	0.3	—	—	—	Deflection Amp.	250	47*	150	2.1	45	—	—	—	—	—	25BQ6GT	
25C6G	Beam Power Amplifier	O	7AC	25	0.3	—	—	—	Class-A1 Amp.	135	-13.5	135	3.5/11.5	58/60	9300	7000	—	—	—	25C6G	
25D8GT	Diode Triode Pentode	O	8AF	25	0.15	—	—	—	Triode Amp.	100	-1.0	—	—	—	—	—	—	—	—	25D8GT	
25L6	Beam Power Amplifier	O	7AC	25	0.3	16	13.5	0.30	Pentode Amp.	100	-3.0	100	2.7	8.5	200000	1900	100	—	—	25L6	
25N6G	Direct-Coupled Triodes	O	7W	25	0.3	—	—	—	Class-A1 Amp.	110	-8.0	110	3.5/10.5	45/48	10000	8000	80	3000	2.2	25N6G	
26A7GT	Twin Beam-Power Audio Amplifier	O	8BU	26.5	0.6	—	—	—	Class-A Amp.	110	0	110	7	45	11400	2200	25	2000	2.0	26A7GT	
32L7GT	Diode-Beam Tetrode	O	8Z	32.5	0.3	—	—	—	Class-AB Amp.	26.5	-4.5	26.5	2/5.5	20/20.5	2500	5500	—	—	—	32L7GT	
35A5	Beam Power Amplifier	L	6AA	35	0.15	—	—	—	Class-A Amp.	110	-7.5	110	3	40	15000	6000	—	—	—	35A5	
35L6G	Beam Power Amplifier	O	7AC	35	0.15	13	9.5	0.80	Class-A1 Amp.	110	-7.5	110	3/7	40/41	14000	5800	—	—	—	35L6G	
43	Pentode Power Amplifier	M	6B	25	0.3	8.5	12.5	0.20	Class-A Amp.	95	-15.0	95	4.0	20.0	45000	2000	90	4500	0.90	43	
48	Tetrode Power Amplifier	M	6A	30	0.4	—	—	—	Class-A Amp.	96	-19.0	96	9.0	52.0	—	—	—	—	—	48	
50A5	Beam Power Amplifier	L	6AA	50	0.15	—	—	—	Class-A1 Amp.	110	-7.5	110	4/11	49/50	10000	8200	—	—	—	50A5	
50C6GT	Beam Power Amplifier	O	7AC	50	0.15	—	—	—	Class-A1 Amp.	135	-13.5	135	3.5/11.5	58/60	9300	7000	—	—	—	50C6GT	
50L6GT	Beam Power Amplifier	O	7AC	50	0.15	—	—	—	Class-A Amp.	110	-7.5	110	4/11	49/50	8200	4100	82	2000	2.2	50L6GT	
70A7GT	Diode-Beam Tetrode	O	8AB	70	0.15	—	—	—	Class-A Amp.	110	-7.5	110	3.0	40	—	—	—	—	—	70A7GT	
117L7GT/117M7GT	Rectifier-Amplifier	O	8AA	70	0.15	—	—	—	Class-A1 Amp.	110	-7.5	110	3/6	40/43	15000	7500	—	—	—	117L7GT/117M7GT	
117N7GT	Rectifier-Amplifier	O	8AO	117	0.09	—	—	—	Class-A Amp.	105	-5.2	105	4/5.5	43	17000	5300	—	—	—	117N7GT	
117P7GT	Rectifier-Amplifier	O	8AV	117	0.09	—	—	—	Class-A Amp.	100	-6.0	100	5.0	51	16000	7000	—	—	—	117P7GT	
		O	8AV	117	0.09	—	—	—	Class-A Amp.	105	-5.2	105	4/5.5	43	17000	5300	—	—	—	117P7GT	

Courtesy ARRL Handbook

# RECEIVING TUBE SUBSTITUTION GUIDE

TABLE IX—HIGH-VOLTAGE HEATER TUBES—Continued

Type	Name	Base	Socket Connections	Heater		Capacitance $\mu$ fd.			Plate-Grid	Use	Plate Supply Volts	Grid Bias	Screen Volts	Screen Current Ma.	Plate Current Ma.	Plate Resistance Ohms	Transconductance Micromhos	Amp. Factor	Load Resistance Ohms	Power Output Watts	Type
				Volts	Amp.	In	Out	In													
1280	Pentode	L	8V	12.6	0.15	6.0	6.5	0.007	Class-A Amp.	250	-3.0	100	2.5	9.0	830000	2000	—	—	—	1284	
1284	U.h.f. Pentode	L	8V	12.6	0.15	5.0	6.0	0.01	Class-A Amp.	250	-3.0	100	2.5	9.0	830000	2000	—	—	—	1623	
1629	Electron-Ray Tube	O	6RA	12.6	0.15	—	—	—	Indicator Tube	—	—	—	—	—	—	—	—	—	—	1631	
1631	Beam Power Amplifier	O	7AC	12.6	0.45	—	—	—	Class-A Amp.	—	—	—	—	—	—	—	—	—	—	1632	
1632	Beam Power Amplifier	O	7AC	12.6	0.6	—	—	—	Class-A Amp.	—	—	—	—	—	—	—	—	—	—	1633	
1633	Twin Triode	O	8BD	25	0.15	—	—	—	Class-A Amp.	—	—	—	—	—	—	—	—	—	—	1634	
1634	Twin Triode	O	8S	12.6	0.15	—	—	—	Class-A Amp.	—	—	—	—	—	—	—	—	—	—	1634	
1644	Twin Pentode	O	Fig. 7	12.6	0.15	—	—	—	Class-A Amp.	160	-9.0	180	2.8/4.5	13	1600000	2150	—	10000	1.0	XXD/14AF7	
XXD/14AF7	Twin Triode	L	8AC	12.6	0.15	—	—	—	Class-A Amp.	250	-10	—	—	—	—	—	2100	—	—	14AF7	
20D7	Double Beam Power Amplifier	L	8BS	28.0	0.4	—	—	—	Class-A Amp.	28	180*	28 <sup>2</sup>	0.7 <sup>2</sup>	9.0 <sup>2</sup>	—	—	—	4000 <sup>1</sup>	0.08 <sup>2</sup>	28D7	

\* Cathode resistor—ohms.  
<sup>1</sup> 6.3-volt pilot lamp must be connected between Pins 6 and 7.  
<sup>2</sup> Per section—resistance-coupled.  
<sup>3</sup> P.p. operation—values for both sections.  
<sup>4</sup> Plate to plate.  
<sup>5</sup> Values are for each unit.  
<sup>6</sup> Values are for single tube.  
<sup>7</sup> Grids 2 and 3 connected to plate.  
<sup>8</sup> Discontinued.

TABLE X—SPECIAL RECEIVING TUBES

Type	Name	Base	Socket Connections	Fil. or Heater		Capacitance $\mu$ fd.			Plate-Grid	Use	Plate Supply Volts	Grid Bias	Screen Volts	Screen Current Ma.	Plate Current Ma.	Plate Resistance Ohms	Transconductance Micromhos	Amp. Factor	Load Resistance Ohms	Power Output Watts	Type
				Volts	Amp.	In	Out	In													
00-A <sup>7</sup>	Triode Detector	M	4D	5.0	0.25	3.2	2.0	8.50	Grid-Leak Det.	45	—	—	—	—	1.5	30000	666	20	—	00-A	
01-A <sup>7</sup>	Triode Detector Amplifier	M	4D	5.0	0.25	—	—	—	Class-A Amp.	135	-9.0	—	—	—	3.0	10000	800	8.0	—	01-A	
3A8GT	Diode Triode Pentode	O	8AS	2.8	0.05	2.6	4.2	2.0	Class-A Triode	90	0	—	—	—	0.15	240000	275	65	—	3A8GT	
3B5GT	Beam Power Amplifier	O	7AP	1.4	0.1	—	—	—	Class-A Pentode	90	0	90	0.3	1.2	600000	750	—	—	—	3B5GT	
3C5GT	Power Output Pentode	O	7AQ	2.8	0.05	—	—	—	Class-A Amp.	67.5	-7.0	67.5	0.6	8.0	100000	1650	—	5000	0.2	3C5GT	
3C6	Twin Triode	L	7BW	1.4	0.1	—	—	—	Class-A Amp.	90	-9.0	90	1.4	6.0	—	1550	—	—	8000	0.24	
3LE4	Power Amplifier Pentode	L	6BA	2.8	0.05	—	—	—	Class-A Amp.	90	0	—	—	—	—	1450	—	—	10000	0.26	
3LF4	Power Amplifier Tetrode	L	6BB	1.4	0.1	—	—	—	Class-A Amp.	90	-4.5	90	1.3	9.5	75000	2200	—	6000	0.30	3LE4	
3O5GT	Beam Power Amplifier	O	7AQ	2.8	0.05	—	—	—	Class-A Amp.	90	-4.5	90	1.3	9.5	80000	2000	—	8000	0.27	3LF4	
4A6G	Twin Triode Amplifier	O	8L	4	0.12	—	—	—	Class-A Amp.	90	-1.5	—	—	—	2.2	13300	1500	20	—	3O5GT	
6F4	Acorn Triode	A	7BR	6.3	0.225	2.0	0.6	1.90	Class-B Amp.	90	0	—	—	—	4.6	—	—	—	3000	1.0	
6L4	U.H.F. Triode	A	7BR	6.3	0.225	1.3	0.5	1.6	Class-A Amp.	80	150*	—	—	—	13.0	2900	5800	17	—	6F4	
10	Triode Power Amplifier	M	4D	7.5	1.25	4.0	3.0	7.00	Class-A Amp.	425	-32.0	—	—	—	9.5	4400	6400	28	—	6L4	
11/12 <sup>7</sup>	Triode Detector Amplifier	M	4F/4D	1.1	0.25	—	—	—	Class-A Amp.	—	-10.5	—	—	—	3.0	15000	440	6.6	—	11/12	
20 <sup>7</sup>	Triode Power Amplifier	S	4D	3.3	0.132	2.0	2.3	4.10	Class-A Amp.	135	-22.5	—	—	—	6.5	6300	525	3.3	6500	0.11	
22 <sup>7</sup>	Tetrode R.F. Amplifier	M	4K	3.3	1.03	2.8	2.5	8.10	Class-A Amp.	180	-14.5	—	—	—	3.7	325000	500	160	—	22	
26	Triode Amplifier	M	4D	5.0	0.25	2.8	2.2	2.00	Class-A Amp.	180	-3.0	—	—	—	6.2	7300	1150	8.3	—	26	
40 <sup>7</sup>	Triode Voltage Amplifier	M	4D	7.5	1.25	4.2	3.4	7.10	Class-A Amp.	180	-84.0	—	—	—	5.0	150000	200	30	—	40	
50	Triode Power Amplifier	M	4D	7.5	1.25	4.2	3.4	7.10	Class-A Amp.	450	—	—	—	—	55.0	1830	2100	3.8	4350	4.6	

Courtesy ARRL Handbook



# RECEIVING TUBE SUBSTITUTION GUIDE

TABLE X—SPECIAL RECEIVING TUBES—Continued

Type	Name	Base Connections	Socket Connections		FIL or Heater		Capacitance $\mu$ fd.		Use	Plate Supply Volts	Grid Bias	Screen Volts	Screen Current Ma.	Plate Current Ma.	Plate Resistance Ohms	Transconductance Micromhos	Amp. Factor	Load Resistance Ohms	Power Output Watts	Type
			Volts	Amp.	In	Out	Plate-Grid													
71-A	Triode Power Amplifier	M, 4D	5.0	0.25	3.2	2.9	7.50	Class-A Amp.	180	-43.0	—	—	23.0	1750	1700	3.0	4800	0.79	71-A	
99*	Triode Detector Amplifier	S, 4D	3.3	0.063	2.5	2.5	3.30	Class-A Amp.	90	-4.5	—	—	2.5	15500	425	6.6	—	—	99	
112A	Triode Detector Amplifier	M, 4D	5.0	0.25	—	—	—	Class-A Amp.	180	-13.5	—	—	7.7	4700	1800	0.5	—	—	112A	
182B/482B	Triode Amplifier	M, 4D	5.0	1.25	—	—	—	Class-A Amp.	250	-35.0	—	—	18.0	—	1500	5.0	—	—	182B/482B	
183/483	Power Triode	M, 4D	5.0	1.25	—	—	—	Class-A Amp.	250	-60.0	—	—	23.0	18000	1800	3.2	4500	2.0	183/483	
485	Triode	S, 5A	3.0	1.3	—	—	—	Class-A Amp.	180	-9.0	—	—	6.0	9300	1350	12.5	—	—	485	
864	Triode Amplifier	S, 4D	1.1	0.25	—	—	—	Class-A Amp.	90	-4.5	—	—	2.9	13500	610	8.2	—	—	864	
954	Pentode Detector, Amplifier	A, 58B	6.3	0.15	3.4	3.0	0.007	Class-A Amp.	250	-3.0	100	0.7	2.0	1.5 meg.	1400	2000	—	—	954	
								Bias Detector	250	-6.0	100	—	—	Plate current to be adjusted to 0.1 ma. with no signal	—	—	—	—	—	
955	Triode Detector, Amplifier, Oscillator	A, 58C	6.3	0.15	1.0	0.6	1.40	Class-A Amp.	250	-7.0	—	—	6.3	11400	2200	25	—	—	955	
								Class-A Amp.	90	-2.5	—	—	2.5	14700	1700	25	—	—	—	
956	Variable- $\mu$ Pentode R.F. Amplifier	A, 58B	6.3	0.15	3.4	3.0	0.007	Class-A Amp.	250	-3.0	100	2.7	6.7	700000	1800	1440	—	—	956	
								Mixer	250	-10.0	100	—	—	Oscillator peak volts—7 min.	—	—	—	—	—	
957	Triode Detector, Amplifier, Oscillator	A, 58D	1.25	0.05	0.3	0.7	1.20	Class-A Amp.	135	-5.0	—	—	2.0	20800	650	13.5	—	—	957	
958	Triode A.F. Amplifier, Oscillator	A, 58D	1.25	0.1	0.6	0.8	2.60	Class-A Amp.	135	-7.5	—	—	3.0	10000	1200	12	—	—	958	
958-A								Class-A Amp.	145	-3.0	67.5	0.4	1.7	800000	600	480	—	—	958-A	
959	Pentode Detector, Amplifier	A, 58E	1.25	0.05	1.8	2.5	0.015	Class-A Amp.	145	-3.0	67.5	0.4	1.7	800000	600	480	—	—	959	
7E5/1201	U.h.f. Triode	L, 88N	6.3	0.15	3.6	2.8	1.50	Class-A Amp.	180	-3	—	—	3.5	12000	—	36	—	—	7E5/1201	
7C4/1203	U.h.f. Diode	L, 4AH	6.3	0.15	—	—	—	Rectifier	180	-3	—	—	—	Max. r.m.s. voltage—150	—	—	—	—	7C4/1203	
7AB7/1204	Sharp Cut-off Pentode	L, 88O	6.3	0.15	3.5	4.0	0.06	Class-A Amp.	250	-2	100	0.6	1.75	800000	1200	—	—	—	7AB7/1204	
1276	Triode Power Amplifier	M, 4D	4.5	1.14	—	—	—	Class-A Amp.	—	—	—	—	—	Characteristics similar to 6A3	—	—	—	—	1276	
1609	Pentode Amplifier	S, 5B	1.1	0.25	—	—	—	Class-A Amp.	135	-1.5	67.5	0.65	2.5	400000	725	300	—	—	1609	
9004	U.h.f. Diode	A, 48J	6.3	0.15	—	—	—	Detector	—	—	—	—	—	Max. a.c. voltage—117. Max. d.c. output current—5 ma.	—	—	—	—	9004	
9005	U.h.f. Diode	A, 58G	3.6	0.165	—	—	—	Detector	—	—	—	—	—	Max. a.c. voltage—117. Max. d.c. output current—1 ma.	—	—	—	—	9005	
EF-50	Sharp Cut-off Pentode	L, 9C	6.3	0.3	8	5	0.007	I.F.-R.F. Amp.	250	150*	250	3.1	10	600000	6300	—	—	—	EF-50	
GL-2C44	U.h.f. Triode	O, Fig. 17	6.3	0.75	—	—	—	Class-A Amp. and Modulator	250	100*	—	—	25.0	—	7000	—	—	—	GL-2C44	
GL-446A	U.h.f. Triode	O, Fig. 19	6.3	0.75	—	—	—	Oscillator, Amp. or Converter	250	200*	—	—	15.0	—	4500	45	—	—	GL-446A	
GL-446B	U.h.f. Diode	O, Fig. 18	6.3	0.75	—	—	—	Detector or trans. line switch	5.0	—	—	—	24.0	—	—	—	—	—	GL-446B	
559	U.h.f. Diode	O, Fig. 18	6.3	0.75	—	—	—	Detector or trans. line switch	5.0	—	—	—	24.0	—	—	—	—	—	559	
GL-559																			GL-559	
NU-2C35	Special Hi-Mu Triode	O, Fig. 38	6.3	0.3	5.2	2.3	0.62	Shunt Voltage Regulator	8000	-200	—	—	5.0	525000	950	500	—	—	NU-2C35	
VT52	Triode	M, 4D	7.0	1.18	5.0	3.0	7.7	Class-A Amp.	220	-43.5	—	—	29.0	1650	2300	3.8	3800	1.0	VT52	
X6030	Diode	L, Fig. 4	3.0	0.6	—	—	—	Noise Diode	90	—	—	—	4.0	—	—	—	—	—	X6030	

Courtesy ARRL Handbook

TABLE X—SPECIAL RECEIVING TUBES—Continued

Type	Name	Base	Socket Connections	Fil. or Heater		Capacitance $\mu\mu\text{fd}$ .		Plate-Grid	Use	Plate Supply Volts	Grid Bias	Screen Volts	Screen Current Ma.	Plate Current Ma.	Plate Resistance Ohms	Transconductance Micromhos	Amp. Factor	Load Resistance Ohms	Power Output Watts	Type
				Volts	Amp.	In	Out													
XXB	Twin-Triode Frequency Converter	L	Fig. 9	2.8/ 1.4 3.2/ 1.6	0.05/ 0.10	—	—	—	Converter <sup>2</sup>	90 <sup>1</sup>	0	—	—	4.5 <sup>1</sup> 4.5 <sup>1</sup>	1300 <sup>1</sup> 1300 <sup>1</sup>	14.5 <sup>1</sup>	—	—	—	XXB
XXFM	Twin-Diode Triode	L	8BZ	6.3	0.3	—	—	—	Class-A Amp.	250 100	0 0	—	—	1.9 1.2	6700 85000	100 85	—	—	—	XXFM

\* Cathode resistor—ohms.

<sup>1</sup> Both sections.

<sup>2</sup> Dry battery operation.

<sup>3</sup> Section No. 2.

<sup>4</sup> Same as 199. Type V99 is same, but socket connections are 4E.

<sup>5</sup> Discontinued.

TABLE XI—MINIATURE RECEIVING TUBES  
Other miniature types in Tables XIII and XV

Type	Name	Base	Socket Connections	Fil. or Heater		Capacitance $\mu\mu\text{fd}$ .		Plate-Grid	Use	Plate Supply Volts	Grid Bias	Screen Volts	Screen Current Ma.	Plate Current Ma.	Plate Resistance Ohms	Transconductance Micromhos	Amp. Factor	Load Resistance Ohms	Power Output Watts	Prototype	
				Volts	Amp.	In	Out														
1A3	H. F. Diode	B	5AP	1.4	0.15	—	—	—	Detector F.M. Discrim.	90	0	90	2.0	4.5	500000	1025	—	—	—	1N5GT	
1L4	Sharp Cut-off Pentode	B	6AR	1.4	0.05	3.6	7.5	.008	Class-A Amp.	90	0	67.5	3.0	1.7	300000	300	—	—	—	1A78T	
1R5	Pentagrid Converter	B	7AT	1.4	0.05	—	—	—	Converter	90	-7.0	67.5	1.4	7.4	100000	1575	—	8000	—	1G95T	
1S4	Pentagrid Power Amp.	B	7AV	1.4	0.1	—	—	—	Class-A Amp.	67.5	0	67.5	0.4	1.6	600000	625	—	—	—	—	
1S5	Diode Pentode	B	6AU	1.4	0.05	—	—	—	R-Coupled Amp.	90	0	90	—	—	—	—	—	1 meg.	—	0.050	
1T4	Variable- $\mu$ Pentode	B	6AR	1.4	0.05	3.6	7.5	0.01	Class-A Amp.	90	0	67.5	1.4	3.5	500000	900	—	—	—	—	1P9GT
1U4	Sharp Cut-off Pentode	B	6AR	1.4	0.05	3.6	7.5	0.01	Class-A Amp.	90	0	90	0.5	1.6	1500000	900	—	—	—	—	1N5GT
1U5	Diode Pentode	B	6BW	1.4	0.05	—	—	—	Class-A Amp.	67.5	0	67.5	0.4	1.6	600000	625	—	—	—	—	—
2C31	Twin Triode	B	8CJ	6.3	0.3	2.2	1.0	1.3	Class-A Amp.	150	-2	—	—	8.2 <sup>1</sup>	—	3500	—	—	—	—	7F8
2E30	Beam Power Pentode	B	7CQ	6.0	0.7	10	4.5	0.5	Class-A Single	250	450*	250	7.1	44 <sup>1</sup>	63000	3700	40 <sup>1</sup>	4800	—	—	—
3A4	Power Amplifier Pentode	B	7BB	1.4 2.8	0.2 0.1	4.8	4.2	0.34	Class-A Amp. <sup>2</sup>	250	225*	250	14.3 <sup>1</sup>	88 <sup>1</sup>	—	—	—	—	—	—	—
3A5	H.F. Twin Triode	B	7BC	1.4 2.8	0.22 0.11	0.9	1.0	3.20	Class-AB Amp. <sup>3</sup>	250	-25	250	15.5 <sup>2</sup>	80 <sup>1</sup>	—	—	—	—	—	—	—
3C4	Power Amplifier Pentode	B	7BA	1.4	0.1	Series Filaments	—	—	Class-A Amp.	90	-2.5	—	—	3.7	8900	1800	15	—	—	—	
3S4	Power Amplifier Pentode	B	7BA	1.4	0.1	Parallel Filaments	—	—	Class-A Amp.	90	-4.5	90	2.1	9.5	100000	2150	—	10000	—	—	
3V4	Power Amplifier Pentode	B	6BX	1.4	0.1	Series Filaments	—	—	Class-A Amp.	90	-7.0	67.5	1.4	7.4	100000	1575	—	8000	—	—	
6AB4	Triode R.F. Amp.	B	5CE	6.3	0.15	2.2	0.5	1.5	Class-A Amp.	250	-2	—	—	10	—	5500	85	—	—	—	
6AG5	Sharp Cut-off Pentode	B	7BD	6.3	0.3	—	—	—	Class-A Amp.	250	200*	150	2.0	7.0	800-00	5000	—	—	—	—	
6AH6	Sharp Cut-off Pentode	B	7CC	6.3	0.45	10	2	0.03	Pentode Amp.	100	160*	150	1.6	5.5	300000	4750	—	—	—	—	
6AJ5	Sharp Cut-off Pentode	B	7PM	6.3	0.175	—	—	—	Triode Amp. <sup>1</sup>	150	160*	—	—	12.5	3600	11000	40	—	—	—	
6AK5	Sharp Cut-off Pentode	B	7BD	6.3	0.175	4.3	2.1	0.03	R.F. Amplifier	180	200*	120	2.4	7.7	600000	5100	—	—	—	—	
									Class-AB Amp. <sup>3</sup>	150	330*	140	2.2	7.0	420000	4300	—	—	—	—	—
									R.F. Amplifier	120	200*	120	2.5	7.5	340000	5000	1700	—	—	—	

Courtesy ARRL Handbook

RECEIVING TUBE SUBSTITUTION GUIDE

TABLE XI—MINIATURE RECEIVING TUBES—Continued

Type	Name	Base	Socket Connect-ions	Fill. or Heater		Capacitance $\mu\text{fd.}$			Plate-Grid	Use	Plate Supply Volts	Grid Bias	Screen Volts	Screen Current Ma.	Screen Current Ma.	Plate Current Ma.	Plate Resistance Ohms	Transcon-ductance Micromhos	Amp. Factor	Load Resistance Ohms	Power Output Watts	Prototype
				Volts	Amp.	In	Out	In														
6AK6	Power Amplifier Pentode	B	7BK	6.3	0.15	3.6	4.2	0.12	Class-A Amp.	180	-9.0	180	2.5	15.0	200000	2300	—	—	10000	1.1	—	6H6GT
6AL5	U.h.f. Twin Diode	B	6BT	6.3	0.3	—	—	—	Detector	120	-6	120	12	35	12500	8000	—	—	—	—	—	6AG7
6AN5	Power Amp. Pentode	B	7BD	6.3	0.5	9.0	4.8	0.05	Class-A Amp.	120	-6	120	12	35	12500	8000	—	—	—	—	—	6AG7
6AN6	Twin Diode	B	7BJ	6.3	0.2	—	—	—	Detector	120	-6	120	12	35	12500	8000	—	—	—	—	—	6AG7
6AQ5	Beam Power Tetrode	B	7BZ	6.3	0.45	7.6	6.0	0.35	Class-A Amp.	180	-8.5	180	4.0	30	50000	3700	29	—	5000	2.0	—	6V6GT
6AQ6	Duo-diode Hi-mu Triode	B	7BT	6.3	0.15	1.7	1.5	1.80	Class-A Triode	250	-3.0	250	7.0	47	32000	4100	45	—	5000	4.5	—	6V6GT
6AR5	Pentode Power Amp.	B	6CC	6.3	0.4	—	—	—	Class-A Amp.	100	-1.0	250	5.5	33	60000	2300	—	—	7000	3.4	—	6K6GT
6AS3	Beam Pentode	B	7CV	6.3	0.8	12	6.2	0.6	Class-A Amp.	250	-16.5	250	5.5	35	65000	2400	—	—	4500	2.2	—	—
6AS6	Sharp Cut-off Pentode	B	7CM	6.3	0.175	4.0	3.0	0.02	Class-A Amp.	120	-2	120	3.5	5.3	—	3500	—	—	—	—	—	—
6AT6	Duplex Diode Triode	B	7BT	6.3	0.3	2.3	1.1	2.10	Class-A Amp.	250	-3	250	—	—	—	—	—	—	—	—	—	—
6AU6	Sharp Cut-off Pentode	B	7BK	6.3	0.3	5.5	5.0	.0035	Class-A Amp.	250	-1	150	4.3	10.8	200000	5200	—	—	—	—	—	—
6AV6	Duo-diode Hi-mu Triode	B	7BT	6.3	0.3	—	—	—	Class-A Amp.	250	-2	100	4.2	11	1500000	4400	—	—	—	—	—	—
6BA6	Remote Cut-off Pentode	B	7CC	6.3	0.3	5.5	5.0	.0035	Class-A Amp.	250	68*	100	10	3.8	1000000	3.5	—	—	—	—	—	—
6BA7	Pentagrid Converter	B	8CT	6.3	0.3	9.5	8.3	—	Converter	250	-1	100	5	13	120000	2350	—	—	—	—	—	—
6BD6	Remote Cut-off Pentode	B	7CC	6.3	0.3	—	—	—	Class-A Amp.	250	-3	100	3.5	9	700000	2000	—	—	—	—	—	—
6BS6	Pentagrid Converter	B	7CH	6.3	0.3	Osc. Grid	50000	□	Converter	250	-1.5	100	7.8	3.0	1000000	475	—	—	—	—	—	—
6BR6	Duplex-Diode Triode	B	7BT	6.3	0.3	1.8	1.1	2.0	Class-A Amp.	250	-9	—	—	—	8500	1900	—	—	10000	—	—	—
6BH6	Sharp Cut-off Pentode	B	7CM	6.3	0.15	5.4	4.4	0.0035	Class-A Amp.	250	-1	150	2.9	7.4	1400000	4600	—	—	—	—	—	—
6BJ6	Remote Cut-off Pentode	B	7CM	6.3	0.15	4.5	5.0	.0035	Class-A Amp.	250	-1	100	3.3	9.2	1300000	3800	—	—	—	—	—	—
6CA	Triode Amplifier	B	6BG	6.3	0.15	1.8	1.3	1.40	Class-A Amp.	250	-8.5	—	—	—	7700	2200	—	—	—	—	—	—
6CA	U.h.f. Grounded-Grid R.F. Amplifier	B	7BQ	6.3	0.4	5.5	0.24	4.0	Grounded-Grid	150	200*	—	—	—	15.0	4500	12000	55	—	—	—	—
6C6	Twin Triode	B	7BF	6.3	0.45	2.2	0.4	1.6	Class-A Amp.	100	50*	—	—	—	8.5	7100	5300	38	—	—	—	—
6N4	U.h.f. Triode Amplifier	B	7CA	6.3	0.2	3.0	1.6	1.10	Class-A Amp.	180	-3.5	—	—	—	12.0	—	6000	32	—	—	—	—
6T8	Triode-Diode Triode	B	9E	6.3	0.45	1.5	1.1	2.4	Class-A Amp.	250	-3	—	—	—	1.0	5800	1200	70	—	—	—	—
12AL5	Twin Diode	B	6BT	12.6	0.15	2.5	—	—	Detector	100	-1	—	—	—	0.8	5400	1300	70	—	—	—	—
12A16	Duplex Diode Triode	B	7BT	12.6	0.15	2.3	1.1	2.10	Class-A Amp.	250	-3.0	—	—	—	1.0	58000	1200	—	—	—	—	—
12A17	Double Triode	B	9A	6.3	0.3	2.5	0.45	1.45	Class-A Amp.	250	-2	—	—	—	10	10000	5500	55	—	—	—	—
12AU6	Sharp Cut-off Pentode	B	7CC	12.6	0.15	2.5	0.35	1.45	Each Unit	180	-1	—	—	—	11	9400	6400	62	—	—	—	—
12AU7	Twin-Triode Amplifier	B	9A	6.3	0.3	5.3	5.0	.0035	Class-A Amp.	250	-1.0	150	4.3	10.8	1 meg.	5200	—	—	—	—	—	—
12AV6	Duo-diode Hi-mu Triode	B	7BT	12.6	0.15	1.6	0.35	1.5	Class-A Amp.	250	-8.5	—	—	—	10.5	7700	2200	17	—	—	—	—
12AW6	Sharp Cut-off Pentode	B	7CM	12.6	0.15	6.5	1.5	0.025	Class-A Amp.	250	-2	—	—	—	1.2	62500	1600	100	—	—	—	—
12AW7	Sharp Cut-off Pentode	B	7CM	12.6	0.15	6.5	1.5	0.025	Triode Amp.	250	200*	150	2.0	7.0	800000	5000	—	—	—	—	—	—
12AX7	Double Triode	B	9A	12.6	0.15	1.6	0.46	1.7	Class-A Amp.	250	200*	150	2.0	7.0	0.8 meg.	5000	—	—	—	—	—	—
12AY7	Dual Triode	B	9A	6.3	0.3	1.6	0.34	1.7	Class-A Amp.	250	-2	—	—	—	1.2	62500	1600	100	—	—	—	—
12BA6	Remote Cut-off Pentode	B	7CC	12.6	0.15	1.3	0.6	1.3	Class-A Amp.	250	-4	—	—	—	0.5	8000	1250	100	—	—	—	—
				12.6	0.15	5.5	5.0	.0035	Lo-Level Amp.	150	2700*	100	—	—	3	—	1750	40	—	—	—	—
				12.6	0.15	5.5	5.0	.0035	Class-A Amp.	250	68*	100	—	—	4.2	1500000	4400	—	—	—	—	—

Courtesy ARRL Handbook

RECEIVING TUBE SUBSTITUTION GUIDE

TABLE XI — MINIATURE RECEIVING TUBES — Continued

Type	Name	Base	Socket Connections <sup>1</sup>	Fil. or Heater		Capacitance $\mu\text{fd.}$			Plate-Grid	Use	Plate Supply Volts	Grid Bias	Screen Volts	Screen Current Ma.	Plate Current Ma.	Plate Resistance Ohms	Transcon-ductance Micromhos	Amp. Factor	Load Resistance Ohms	Power Output Watts	Prototype
				Volts	Amp.	In	Out	In													
12BA7	Pentagrid Converter	B.	8CT	12.6	0.15	9.5	8.3	—	—	250	-1	100	10	3.8	1000000	3.5	—	—	—	—	—
12BD6	Remote Cut-off Pentode	B.	7CC	12.6	0.15	4.3	5.0	.004	—	Class-A Amp.	250	-3	100	3.5	9.0	700000	2000	—	—	—	12SK7GT
12BE6	Pentagrid Converter	B.	7CH	12.6	0.15	Osc. Grid 50000 $\Omega$	—	—	—	Converter	250	-1.5	100	7.8	3.0	1000000	475	—	—	—	12SA7GT
12BF6	Duodiode Triode	B.	7BT	12.6	0.15	1.8	1.1	2.00	—	Class-A Amp.	250	-9	—	—	9.5	1900	16	—	—	—	12SR7GT
19A6	Twin Triode	B.	7BF	18.9	0.15	2.0	0.4	1.5	—	Class-A Amp.	100	50*	—	—	8.5	7100	5300	—	—	—	—
19T8	Triode-Diode Triode	B.	9E	18.9	0.15	1.5	1.1	2.4	—	Class-A Amp.	250	-3	—	—	1.0	5800	1200	—	—	—	—
26A6	Remote Cut-off Pentode	B.	7BK	26.5	0.07	6.0	5.0	.0035	—	Class-A Amp.	250	125*	100	4	10.5	1000000	4000	—	—	—	—
26C6	Duplex-Diode Triode	B.	7BT	26.5	0.07	1.8	1.4	2	—	Class-A Amp.	250	-9	—	—	9.5	8500	1900	—	—	—	—
26D6	Pentagrid Converter	B.	7CH	26.5	0.07	Osc. Grid 20000 $\Omega$	—	—	—	Converter	250	-1.5	100	7.8	3.0	1000000	475	—	—	—	—
35B5	Beam Power Amplifier	B.	7BZ	35	0.15	11	6.5	0.4	—	Class-A Amp.	110	-7.5	110	7	41	—	5800	40	2500	1.5	35L6GT
35C5	Beam Power Amplifier	B.	7CV	35	0.15	12	6.2	0.57	—	Class-A Amp.	110	-7.5	110	3/7	40/41	—	5800	—	2500	1.5	—
50B5	Beam Power Amplifier	B.	7BZ	50	0.15	13	6.5	0.50	—	Class-A Amp.	110	-7.5	110	4.0	49.0	14000	7500	—	3000	1.9	50L6GT
50C5	Beam Power Amplifier	B.	7CV	50	0.15	—	—	—	—	Class-A Amp.	110	-7.5	110	4/8.5	49/50	10000	7500	—	2500	1.9	—
5590	Pentode	B.	7BD	6.3	0.15	3.4	2.9	0.01	—	Class-A Amp.	90	820*	90	1.4	3.9	300000	2000	—	—	—	—
5591	R.F. Pentode	B.	7BD	6.3	0.15	3.9	2.85	0.01	—	Class-A Amp.	180	200*	120	2.4	1.7	690000	5100	—	—	—	—
5654	Sharp Cut-off Pentode	B.	7BD	6.3	0.175	4	2.9	0.02	—	Class-A Amp.	120	200*	120	2.5	7.5	340000	5000	—	—	—	—
5687	Dual Triode	B.	9H	12.6	0.45	4	0.45	3.1	—	Class-A Amp.	250	-12.5	—	—	16	4000	4100	—	—	—	—
5722	Noise Generating Diode	B.	5CB	2/3.5	1.6	—	—	—	—	Noise Generator	200	—	—	—	35	—	—	—	—	—	—
9001	Sharp Cut-off Pentode	B.	7PM	6.3	0.15	3.6	3.0	0.01	—	Class-A Amp.	250	-3.0	100	0.7	2.0	1 meg.	1400	—	—	—	—
9002	Triode Detector, Amplifier, Oscillator	B.	7TM	6.3	0.15	1.2	1.1	1.40	—	Mixer	250	-5.0	100	Osc. peak voltage 4 volts	6.3	11400	2200	—	—	—	—
9003	Remote Cut-off Pentode	B.	7PM	6.3	0.15	3.6	3.0	0.01	—	Class-A Amp.	90	2.5	—	—	2.5	14700	1700	—	—	—	—
9006	U.h.f. Diode	B.	6BH	6.3	0.15	—	—	—	—	Mixer	250	-3.0	100	Osc. peak voltage 9 volts	6.7	700000	1800	—	—	—	—

\* Cathode resistor—ohms.  
<sup>1</sup> Per Plate.  
<sup>2</sup> Maximum-signal current for full-power output.  
<sup>3</sup> Values are for two tubes in push-pull.  
<sup>4</sup> Also no-signal plate ma. when so indicated.  
<sup>5</sup> No signal plate ma.  
<sup>6</sup> Effective plate-to-plate.  
<sup>7</sup> Triode No. 1.  
<sup>8</sup> Triode No. 2.  
<sup>9</sup> Grid No. 2 tied to plate and No. 3 to cathode.  
 Max. a.c. voltage—270. Max. d.c. output current—5 ma.

TABLE XII — SUB-MINIATURE TUBES

Type	Name	Base	Socket Connections	Fil. or Heater		Capacitance $\mu\text{fd.}$			Plate-Grid	Use	Plate Supply Volts	Grid Bias	Screen Volts	Screen Current Ma.	Plate Current Ma.	Plate Resistance Ohms	Transcon-ductance Micromhos	Amp. Factor	Load Resistance Ohms	Power Output Watts	Type
				Volts	Amp.	In	Out	In													
1AG5	Power Pentode	Bs.	Fig. 14	1.25	0.04	—	—	—	—	Class-A Amp.	67.5	-4.5	67.5	0.4	2.0	150000	730	—	25000	0.05	1AG5
1AD5	Sharp Cut-off Pentode	Bs.	Fig. 16	1.25	0.04	1.8	2.8	0.01	—	Class-A Amp.	67.5	0	67.5	0.75	1.85	700000	735	—	—	—	1AD5
1C8	Heptode	—	—	1.25	0.04	6.5	4.0	0.25	—	Converter	30	0	30	0.75	0.32	300000	100	—	—	—	1C8
1E8	Pentagrid Converter	Bs.	Fig. 27	1.25	0.04	6	—	—	—	Converter	67.5	0	67.5	1.5	1.0	—	150	—	—	—	1E8
1T6	Diode-Pentode	Bs.	Fig. 28	1.25	0.04	—	—	—	—	Class-A Amp.	67.5	0	67.5	0.4	1.6	400000	600	—	—	—	1T6
1W5	Audio Pentode	1	?	1.25	0.04	—	—	—	—	Class-A Amp.	67.5	-4.5	67.5	0.4	2.0	150000	730	—	25000	0.05	1W5
2E31	Sharp Cut-off Pentode	1	?	1.25	0.05	2.3	3.5	0.01	—	Class-A Amp.	67.5	0	67.5	0.75	1.85	700000	735	—	—	—	1W5
2E32	R.F. Pentode	1	?	1.25	0.05	—	—	—	—	Class-A Amp.	22.5	0	22.5	0.3	0.4	—	500	—	—	—	2E31
2E35	Audio Pentode	1	?	1.25	0.03	—	—	—	—	Class-A Amp.	22.5	0	22.5	0.3	0.4	350000	500	—	—	—	2E32
2E36	Audio Pentode	1	?	1.25	0.03	—	—	—	—	Class-A Amp.	45	-1.25	45	0.11	0.45	250000	385	—	150000	0.0012	2E35
2E41	Diode Pentode	1	?	1.25	0.03	—	—	—	—	Detector Amp.	22.5	0	22.5	0.07	0.27	220000	385	—	100000	0.006	2E36
2E42	Diode Pentode	1	?	1.25	0.03	—	—	—	—	Detector Amp.	22.5	0	22.5	0.12	0.35	250000	375	—	1 meg.	—	2E41

Courtesy ARRL Handbook

RECEIVING TUBE SUBSTITUTION GUIDE

TABLE XII — SUB-MINIATURE TUBES — Continued

Type	Name	Base	Socket Connections	Pl. or Heater	Capacitance	Grids	Plate Supply Volts	Grid Bias	Screen Volts	Screen Current Ma.	Plate Current Ma.	Plate Resistance Ohms	Transcon-ductance Micromhos	Amp. Factor	Lead Resistance Ohms	Power Output Watts	Type
2G21	Triode Heptode Converter	1	1	1.25	0.05	—	22.5	—	22.5	0.2	0.3	—	75	—	—	—	2G21
2G22	Triode Converter	1	2	1.25	0.05	—	22.5	0	22.5	0.3	0.2	500000	60	—	—	—	2G22
6K4	Triode Diode	1	2	6.3	0.15	2.4	200	680*	—	—	11.5	4650	3450	16	—	—	6K4
1247	Pentode Voltage Amplifier	1	2	0.7	0.065	—	30	0	Max. a.c. volts—300 D.C. plate current—0.4 Ma.	—	—	1000000	325	—	—	—	1247
CK501	Pentode Voltage Amplifier	1	2	1.25	0.033	—	45	-1.25	45	0.085	0.28	1500000	300	—	—	—	CK501
CK502	Pentode Output Amplifier	1	2	1.25	0.033	—	30	0	30	0.18	0.55	500000	400	—	60000	0.003	CK502
CK503	Pentode Output Amplifier	1	2	1.25	0.033	—	30	0	30	0.33	1.5	150000	600	—	20000	0.006	CK503
CK504	Pentode Output Amplifier	1	2	1.25	0.033	—	30	-1.25	30	0.09	0.4	900000	350	—	60000	0.003	CK504
CK505	Pentode Voltage Amplifier	1	2	0.625	0.03	—	30	0	30	0.07	0.17	1100000	140	—	—	—	CK505
CK506	Pentode Output Amplifier	1	2	1.25	0.05	—	45	-4.5	45	0.4	1.25	2000000	150	—	—	—	CK506
CK507	Pentode Output Amplifier	1	2	1.25	0.05	—	45	-2.5	45	0.21	0.6	3600000	500	—	80000	0.010	CK507
CK509	Triode Voltage Amplifier	1	2	0.625	0.03	—	45	0	—	—	—	1500000	160	14	1000000	—	CK509
CK510	Dual Space-Charge Tetrode	1	2	0.625	0.05	—	45	0	0.2	200 $\mu$ c	40 $\mu$ c	500000	65	32.8	—	—	CK510
CK512	Low Microphonic Pentode	1	2	0.625	0.02	—	22.5	0	22.5	0.04	0.125	—	160	—	—	—	CK512
CK515BX	Triode Voltage Amplifier	1	2	0.625	0.03	—	45	0	—	—	—	—	160	—	—	—	CK515BX
CK520AX	Audio Pentode	1	2	0.625	0.05	—	45	-2.5	45	0.07	0.24	—	180	—	0.0045	—	CK520AX
CK521AX	Audio Pentode	1	2	1.25	0.05	—	22.5	-3	22.5	0.22	0.8	—	400	—	—	—	CK521AX
CK522AX	Audio Pentode	1	2	1.25	0.02	—	22.5	-3	22.5	0.08	0.3	—	450	—	—	—	CK522AX
CK523AX	Pentode Output Amp.	1	—	1.25	0.03	—	22.5	-1.2	22.5	0.075	0.3	—	360	—	0.0025	—	CK523AX
CK524AX	Pentode Output Amp.	1	—	1.25	0.03	—	15	-1.75	15	0.125	0.45	—	300	—	—	—	CK524AX
CK525AX	Pentode Output Amp.	1	—	1.25	0.2	—	22.5	-1.2	22.5	0.06	0.25	—	325	—	0.0022	—	CK525AX
CK526AX	Pentode Output Amp.	1	—	1.25	0.2	—	22.5	-1.5	22.5	0.12	0.45	—	460	—	0.004	—	CK526AX
CK527AX	Pentode Output Amp.	1	—	1.25	0.015	—	22.5	-1.5	22.5	0.025	0.1	—	75	—	—	—	CK527AX
CK529AX	Shielded Output Pentode	1	—	1.25	0.02	—	15	-1.5	15	0.05	0.2	—	275	—	—	0.0012	CK529AX
CK531AXA	Diode Pentode	1	2	1.25	0.03	—	22.5	0	22.5	0.04	0.17	—	235	—	—	—	CK531AXA
CK533AXA	R.F. Pentode	1	2	1.25	0.05	—	22.5	0	22.5	0.13	0.42	—	880	—	—	—	CK533AXA
CK556AX	U.h.f. Triode	1	2	1.25	0.125	—	135	-5	—	—	4.0	—	1600	—	—	—	CK556AX
CK569AX	R.F. Triode	1	2	1.25	0.07	—	135	-6	—	—	1.9	—	450	—	—	—	CK569AX
CK605CX	Sharp Cut-off Pentode	1	—	6.3	0.2	—	67.5	0	67.5	0.48	1.8	—	1100	—	—	—	CK605CX
CK606BX	Single Diode	1	2	6.3	0.15	—	120	-2	120	2.5	7.5	—	8000	—	—	—	CK606BX
CK619CX	Hi-Mu Triode	1	2	6.3	0.2	—	150 a.c.	—	—	—	9.0 a.c.	—	9000	—	—	0.75	CK619CX
CK624CX	Sharp Cut-off Pentode	1	—	6.3	0.2	—	250	-2	—	—	4.0	—	4000	—	—	—	CK624CX
CK650AX	Sharp Cut-off Pentode	1	2	6.3	0.2	—	120	-2	120	3.5	5.2	—	3000	—	—	—	CK650AX
CK5672	Pentode Output Amp.	1	—	1.25	0.05	—	67.5	-6.25	67.5	1.0	2.75	—	625	—	—	0.06	CK5672
HY113	Triode Amplifier	1	5K	1.4	0.07	—	45	-4.5	—	—	0.4	25000	250	6.3	40000	0.0065	HY113
HY115	Pentode Voltage Amplifier	1	5K	1.4	0.07	—	45	-1.5	22.5	0.008	0.03	5700000	58	300	—	—	HY115
HY145	Pentode Power Amplifier	1	5K	1.4	0.07	—	45	-1.5	45	0.1	0.48	1500000	270	370	—	—	HY145
HY155	Tetrode Power Amplifier	1	2	0.625	0.04	—	45	-3.0	45	0.2	0.9	825000	310	255	50000	0.0115	HY155
M54	Tetrode Voltage Amplifier	1	2	0.625	0.02	—	30	0	30	0.3	2.6	420000	430	190	28000	0.09	HY125
M64	Tetrode Voltage Amplifier	1	2	0.625	0.02	—	30	0	30	0.06	0.5	130000	200	26	35000	0.003	M54
M74	Tetrode Voltage Amplifier	1	2	0.625	0.02	—	30	0	—	—	0.03	200000	110	25	—	—	M64
SK61	Gas Triode	1	2	1.4	0.05	—	30	0	7.0	0.01	0.02	500000	125	70	—	—	M74
SD917A	Triode	1	2	6.3	0.15	2.6	100	820*	—	—	1.5	—	—	—	—	—	SK61
5637	Triode	1	2	6.3	0.15	0.7	100	820*	—	—	1.4	26000	2700	70	—	—	SD917A
5637	Triode	1	2	6.3	0.15	0.7	100	820*	—	—	1.4	26000	2700	70	—	—	5637

Courtesy ARRL Handbook



RECEIVING TUBE SUBSTITUTION GUIDE

TABLE XII — SUB-MINIATURE TUBES — Continued

Type	Name	Base	Socket Connections	Fil. or Heater		Capacitance $\mu$ fd.		Use	Plate Supply Volts	Grid Bias	Screen Volts	Screen Current Ma.	Plate Current Ma.	Plate Resistance Ohms	Transcon- distance Micromhos	Amp. Factor	Load Resistance Ohms	Power Output Watts	Type
				Volts	Amp.	In	Out												
5D828A	Audio Pentode	1	2	6.3	0.15	4.0	3.0	Class-A; Amp.	100	270*	100	1.25	4.8	150000	3300	—	—	—	5D828A
5638																			5638
5D828E	Sharp Cut-off Pentode	1	—	6.3	0.15	4.4	2.8	Class-A; Amp.	100	150*	100	2.5	6.5	240000	3500	—	—	—	5D828E
5634																			5634
5N944	Remote Cut-off Pentode	1	—	6.3	0.15	4.0	2.8	Class-A; Amp.	100	150*	100	2.8	7.0	200000	3400	—	—	—	5N944
5633																			5633
5N946	Diode	1	2	6.3	0.15	1.8	—	Rectifier	150	—	—	—	9.0	—	—	—	—	—	5N946
5N947D	Audio Beam Pentode	1	2	6.3	0.45	—	—	Class-A; Amp.	100	-9	100	2.2	31.0	15000	5000	—	3000	—	5N947C
5640																			5640
5N948C	Voltage Regulator	1	—	—	—	—	—	Regulator	—	—	—	—	—	—	—	—	—	—	5N948C
5N953D	Power Pentode	1	—	6.3	0.15	9.5	3.8	Class-A Amp.	150	100*	100	4/7.5	21/20	50000	9000	—	9000	1.0	5N953D
5N954	Half-Wave Rectifier	1	2	6.3	0.45	—	—	Rectifier	300	—	—	—	45.0	—	—	—	—	—	5N954
5641																			5641
5N955B	Dual Triode	1	2	6.3	0.45	2.8	1.0	Class-A; Amp.	100	100*	—	—	5.5	8000	4250	34	—	—	5N955B
5N956B	H.V. Half-Wave Rectifier	1	—	1.25	0.14	—	—	H.V. Rectifier	—	—	—	—	—	—	—	—	—	—	5N956B
5642																			5642
5N957A	Triode	1	2	6.3	0.15	2.0	1.0	Class-A; Amp.	100	560*	—	—	5.0	7400	2700	20	—	—	5N957A
5645																			5645
5N1006	Triode	1	2	6.3	0.15	—	—	Class-A; Amp.	100	820*	—	—	1.4	29000	2400	70	—	—	5N1006
5N1007B	Mixer	1	—	6.3	0.15	5.0	2.8	0.003 Mixer	100	150*	100	5.0	4.0	230000	900	—	—	—	5N1007B

\* Cathode resistor ohms.

1 No base; tinned wire leads.

2 Leads identified on tube.

3 No screen connection.

4 Double-ended type.

5 Values per triode.

TABLE XIII — CONTROL AND REGULATOR TUBES

Type	Name	Base	Socket Connections	Cathode	Fil. or Heater		Use	Peak Anode Voltage	Max. Anode Ma.	Minimum Supply Voltage	Operating Voltage	Operating Mc.	Grid Resistor	Tube Voltage Drop	Type
					Volts	Amp.									
0A2	Voltage Regulator	7-pin B.	5B0	Cold	—	—	Voltage Regulator	—	—	185	150	5-30	—	—	0A2
0A5	Gas Pentode	7-pin B.	Fig. 33	Cold	—	—	Relay or Trigger	—	—	133	108	5-30	—	—	0A5
0B2	Voltage Regulator	7-pin B.	5B0	Cold	—	—	Voltage Regulator	—	—	—	—	—	—	—	0B2
0A4G	Gas Triode	6-pin O.	4V	Cold	—	—	Cold-Cathode Starter-Anode Relay Tube	—	—	—	—	—	—	—	0A4G
1B67	Voltage Regulator	7-pin B.	—	—	—	—	Voltage Regulator	—	—	225	82	1-2	—	—	1B67
1C21	Gas Triode	6-pin O.	4V	Cold	—	—	Relay Tube	—	—	66 <sup>1</sup>	—	—	—	—	1C21
2A4G	Gas Triode Grid Type	7-pin O.	5S	Fil.	2.5	2.5	Control Tube	125-145	0.1 <sup>1</sup>	180 <sup>1</sup>	—	—	—	—	2A4G
6Q5G	Gas Triode Grid Type	8-pin O.	6Q	Hr.	6.3	0.6	Sweep Circuit Oscillator	200	100	—	—	—	—	—	6Q5G
2B4	Gas Triode	5-pin M.	5A	Hr.	2.5	1.4	Control Tube	300	300	—	—	—	—	—	2B4
2C4	Gas Triode	7-pin B.	5A5	Fil.	2.5	0.65	Control Tube	—	—	—	—	—	—	—	2C4
2B21	Gas Tetrode	7-pin B.	7B8	Hr.	6.3	0.6	Grid-Controlled Rectifier	—	—	—	—	—	—	—	2B21
3C23	Gas and Mercury Vapor Grid Type	4-pin M.	3G	Fil.	2.5	7.0	Grid-Controlled Rectifier	—	—	—	—	—	—	—	3C23
6D4	Gas Triode	7-pin B.	5AY	Hr.	6.3	0.25	Control Tube	—	—	—	—	—	—	—	6D4
17	Mercury Vapor Triode	4-pin M.	3G	Fil.	2.5	5.0	Grid-Controlled Rectifier	7500 <sup>1</sup>	500	—	650	100	0.1-10 <sup>1</sup>	8	17
874	Voltage Regulator	4-pin M.	4S	—	—	—	Voltage Regulator	2500	2000	—	1000	250	—	10-24	874
876	Current Regulator	Megul	—	—	—	—	Current Regulator	—	—	—	—	—	—	—	876
884	Gas Triode Grid Type	6-pin O.	6Q	Hr.	6.3	0.6	Sweep Circuit Oscillator	300	300	—	40-60	1.7	—	—	884
885	Gas Triode Grid Type	5-pin S.	5A	Hr.	2.5	1.4	Grid-Controlled Rectifier	350	300	—	—	—	—	—	885

Characteristics same as Type 884

Courtesy ARRL Handbook

TABLE XIII—CONTROL AND REGULATOR TUBES

Type	Name	Base	Socket Connections	Cathode	Fil. or Heater		Use	Peak Anode Voltage	Max. Anode Ma.	Minimum Supply Voltage	Operating Voltage	Operating Ma.	Grid Resistor	Tube Voltage Drop	Type
					Volts	Amp.									
886	Current Regulator	Mogul 4-pin M.	—	—	—	—	—	—	—	—	40-60	2.05	—	—	886
967	Mercury Vapor Triode	4-pin M.	3G	Fil.	2.5	5.0	Current Regulator	2500	500	-5.1	—	—	—	10-24	967
991	Voltage Regulator	Bayonet	—	—	—	—	Grid-Controlled Rectifier	—	—	87	55-60	2.0	—	—	991
1265	Voltage Regulator	6-pin O.	4AJ	Cold	—	—	Voltage Regulator	—	—	130	90	5-30	—	—	1265
1266	Voltage Regulator	6-pin O.	4AJ	Cold	—	—	Voltage Regulator	—	—	—	70	5-40	—	—	1266
1267	Gas Triode	6-pin O.	4V	Cold	—	—	Relay Tube	—	—	Characteristics same as OA4G					
2050	Gas Triode	8-pin O.	8BA	Htr.	6.3	0.6	Grid-Controlled Rectifier	650	500	—	—	100	0.1-10 <sup>1</sup>	8	2050
2051	Gas Triode	8-pin O.	8BA	Htr.	6.3	0.6	Grid-Controlled Rectifier	350	375	—	—	75	0.1-10 <sup>1</sup>	14	2051
2523N1/128AS	Gas Triode Grid Type	5-pin M.	5A	Htr.	2.5	1.75	Relay Tube	400	300	—	—	1.0	300 <sup>1</sup>	13	2523N1/128AS
5651	Voltage Regulator	7-pin B.	5B0	Cold	—	—	Voltage Regulator	115	—	115	87	1.5-3.5	—	—	5651
KY21	Gas Triode Grid Type	4-pin M.	—	Fil.	2.5	10.0	Grid-Controlled Rectifier	—	—	—	3000	500	—	—	KY21
RK61	Thyatron	—	—	Fil.	1.4	0.05	Relay Tube	45	1.5	30	—	0.5-1.5	3 <sup>1</sup>	30	RK61
RK62	Gas Triode Grid Type	4-pin S.	4D	Fil.	1.4	0.05	Relay Tube	45	1.5	—	30-45	0.1-1.5	—	15	RK62
RM208	Permatron	4-pin M.	—	Fil.	2.5	5.0	Controlled Rectifier <sup>1</sup>	7500 <sup>2</sup>	1000	—	—	—	—	15	RM208
RM209	Permatron	4-pin M.	—	Fil.	5.0	10.0	Controlled Rectifier <sup>1</sup>	7500 <sup>2</sup>	5000	—	—	—	—	15	RM209
OA3/VR73	Voltage Regulator	6-pin O.	4AJ	Cold	—	—	Voltage Regulator	—	—	105	75	5-40	—	—	OA3/VR73
OB3/VR90	Voltage Regulator	6-pin O.	4AJ	Cold	—	—	Voltage Regulator	—	—	125	90	5-40	—	—	OB3/VR90
OC3/VR105	Voltage Regulator	6-pin O.	4AJ	Cold	—	—	Voltage Regulator	—	—	135	105	5-40	—	—	OC3/VR105
OD3/VR150	Voltage Regulator	6-pin O.	4AJ	Cold	—	—	Voltage Regulator	—	—	185	150	5-40	—	—	OD3/VR150
KY866	Mercury Vapor Triode	4-pin M.	Fig. 8	Fil.	2.5	5.0	Grid-Controlled Rectifier	10000	1000	0-150	—	—	—	—	KY866

<sup>1</sup> For use as grid-controlled rectifier or with external magnetic control. RM-208 has characteristics of 866, RM-209 of 872.

<sup>2</sup> When under control peak inverse rating is reduced to 2500.

<sup>3</sup> At 1000 anode volts.

<sup>4</sup> Grid.

<sup>5</sup> Grid tied to plate.

<sup>6</sup> Peak inverse voltage.

<sup>7</sup> Megohms.

<sup>8</sup> Grid voltage.

<sup>9</sup> No base. Tinned wire leads.

Courtesy ARRL Handbook

## RECEIVING TUBE SUBSTITUTION GUIDE

### TABLE XV—RECTIFIERS—RECEIVING AND TRANSMITTING

See also Table XIII—Control and Regulator Tubes

Type No.	Name	Base	Socket Connections	Cathode	Fil. or Heater		Max. A.C. Voltage Per Plate	D.C. Output Current Ma.	Max. Inverse Peak Voltage	Peak Plate Current Ma.	Type	
					Volts	Amp.						
BA	Full-Wave Rectifier	4-pin M.	4J	Cold	—	—	350	350	Tube drop 80 v.	—	G	
BH	Full-Wave Rectifier	4-pin M.	4J	Cold	—	—	350	125	Tube drop 90 v.	—	G	
BR	Half-Wave Rectifier	4-pin M.	4H	Cold	—	—	300	50	Tube drop 60 v.	—	G	
CE-220	Half-Wave Rectifier	4-pin M.	4P	Fil.	2.5	3.0	—	20	20000	100	HV	
OY4	Half-Wave Rectifier	5-pin O.	4BU	Cold	Connect Pins 7 and 8		95	75	300	500	G	
OZ4	Full-Wave Rectifier	5-pin O.	4R	Cold	—	—	350	30-75	1250	200	G	
1	Half-Wave Rectifier	4-pin S.	4G	Hr.	6.3	0.3	350	50	1000	400	MV	
1-V	Half-Wave Rectifier	4-pin S.	4G	Hr.	6.3	0.3	350	50	—	—	HV	
1B3GT/8016	Half-Wave Rectifier	6-pin O.	3C	Fil.	1.25	0.2	—	2.0	4000	17	HV	
1B4B	Half-Wave Rectifier	7-pin B.	—	Cold	—	—	800	6	2700	50	G	
1X2	Half-Wave Rectifier	9-pin B.	Fig. 29	Fil.	1.25	0.2	—	1	15000	10	HV	
1Z2	Half-Wave Rectifier	7-pin B.	7CB	Fil.	1.5	0.3	7800	2	20000	10	HV	
2B25	Half-Wave Rectifier	7-pin B.	3T	Fil.	1.4	0.11	1000	1.5	—	9	HV	
2V3G	Half-Wave Rectifier	6-pin O.	4Y	Fil.	2.5	5.0	—	2.0	16500	12	HV	
2W3	Half-Wave Rectifier	5-pin O.	4X	Fil.	2.5	1.5	350	55	—	—	HV	
2X2/879 <sup>10</sup>	Half-Wave Rectifier	4-pin S.	4AB	Hr.	2.5	1.75	4500	7.5	—	—	HV	
2X2-A	Half-Wave Rectifier	4-pin S.	4AB	Same as 2X2/879 but will withstand severe shock & vibration								HV
2Y2	Half-Wave Rectifier	4-pin M.	4AB	Fil.	2.5	1.75	4400	5.0	—	—	HV	
2Z2/G84	Half-Wave Rectifier	4-pin M.	4B	Fil.	2.5	1.5	350	50	—	—	HV	
3B24	Half-Wave Rectifier	4-pin M.	T-4A	Fil.	5.0	3.0	—	60	20000	300	HV	
3B25	Half-Wave Rectifier	4-pin M.	4P	Fil.	2.5	3.0	—	30	20000	150	HV	
3B25	Half-Wave Rectifier	4-pin M.	4P	Fil.	2.5	5.0	—	500	4500	2000	G	
3B26	Half-Wave Rectifier	8-pin O.	Fig. 31	Hr.	2.5	4.75	—	20	15000	8000	HV	
DR-3B27	Half-Wave Rectifier	4-pin M.	4B	Fil.	2.5	5.0	3000	250	8500	1000	HV	
5A24	Full-Wave Rectifier	5-pin O.	5T	Fil.	5.0	2.0	Same as Type 80					HV
5R4GY	Full-Wave Rectifier	5-pin O.	5T	Fil.	5.0	2.0	900 <sup>4</sup> 950 <sup>7</sup>	150 <sup>4</sup> 175 <sup>7</sup>	2800	650	HV	
5T4	Full-Wave Rectifier	5-pin O.	5T	Fil.	5.0	3.0	450	250	1250	800	HV	
5U4G	Full-Wave Rectifier	8-pin O.	5T	Fil.	5.0	3.0	Same as Type 5Z3					HV
5V4G	Full-Wave Rectifier	8-pin O.	5L	Hr.	5.0	2.0	Same as Type 83V					HV
5W4	Full-Wave Rectifier	5-pin O.	5T	Fil.	5.0	1.5	350	110	1000	—	HV	
5X3	Full-Wave Rectifier	4-pin M.	4C	Fil.	5.0	2.0	1275	30	—	—	HV	
5X4G	Full-Wave Rectifier	8-pin O.	5O	Fil.	5.0	3.0	Same as 5Z3					HV
5Y3G	Full-Wave Rectifier	5-pin O.	5T	Fil.	5.0	2.0	Same as Type 80					HV
5Y4G	Full-Wave Rectifier	8-pin O.	5Q	Fil.	5.0	2.0	Same as Type 80					HV
5Z3	Full-Wave Rectifier	4-pin M.	4C	Fil.	5.0	3.0	500	250	1400	—	HV	
5Z4	Full-Wave Rectifier	5-pin O.	5L	Hr.	5.0	2.0	400	125	1100	—	HV	
6W4GT	Damper Service	6-pin O.	4CG	Hr.	6.3	1.2	—	125	2000	600	HV	
	Half-Wave Rectifier						350	125	1250	600		
6W5G	Full-Wave Rectifier	6-pin O.	6S	Hr.	6.3	0.9	350	100	1250	350	HV	
6X4	Full-Wave Rectifier	7-pin B.	7CF	Hr.	6.3	0.6	325	70	1250	210	HV	
6X5	Full-Wave Rectifier	6-pin O.	6S	Hr.	6.3	0.5	350	75	—	—	HV	
6Y3G	Half-Wave Rectifier	5-pin O.	4AC	Hr.	6.3	0.7	5000	7.5	—	—	HV	
6Y5 <sup>10</sup>	Full-Wave Rectifier	6-pin S.	6J	Hr.	6.3	0.8	350	50	—	—	HV	
6Z3	Half-Wave Rectifier	4-pin M.	4G	Fil.	6.3	0.3	350	50	—	—	HV	
6Z5 <sup>10</sup>	Full-Wave Rectifier	6-pin S.	6K	Hr.	6.3	0.6	230	60	—	—	HV	
6ZY5G	Full-Wave Rectifier	6-pin O.	6S	Hr.	6.3	0.3	350	35	1000	150	HV	
7Y4	Full-Wave Rectifier	8-pin L.	5AB	Hr.	6.3	0.5	350	60	—	—	HV	
7Z4	Full-Wave Rectifier	8-pin L.	5AB	Hr.	6.3	0.9	450 <sup>1</sup> 325 <sup>4</sup>	100	1250	300	HV	
12A7	Rectifier-Pentode	7-pin S.	7K	Hr.	12.6	0.3	125	30	—	—	HV	
12Z3	Half-Wave Rectifier	4-pin S.	4G	Hr.	12.6	0.3	250	60	—	—	HV	
12Z5	Voltage Doubler	7-pin M.	7L	Hr.	12.6	0.3	225	60	—	—	HV	
14Y4	Full-Wave Rectifier	8-pin L.	5AB	Hr.	12.6	0.3	450 <sup>1</sup> 325 <sup>4</sup>	70	1250	210	HV	
14Z3	Half-Wave Rectifier	4-pin S.	4G	Hr.	12.6	0.3	250	60	—	—	HV	
25A7G <sup>10</sup>	Rectifier-Pentode	8-pin O.	8F	Hr.	25	0.3	125	75	—	—	HV	
25W4	Half-Wave Rectifier	6-pin O.	4CG	Hr.	25	0.3	350	125	1250	600	HV	
25X6GT	Voltage Doubler	7-pin O.	7Q	Hr.	25	0.15	125	60	—	—	HV	
25Y4GT	Half-Wave Rectifier	6-pin O.	5AA	Hr.	25	0.15	125	75	—	—	HV	
25Y5 <sup>10</sup>	Voltage Doubler	6-pin S.	6E	Hr.	25	0.3	250	85	—	—	HV	
25Z3	Half-Wave Rectifier	4-pin S.	4G	Hr.	25	0.3	250	50	—	—	HV	
25Z4	Half-Wave Rectifier	6-pin O.	5AA	Hr.	25	0.3	125	125	—	—	HV	
25Z5	Rectifier-Doubler	6-pin S.	6E	Hr.	25	0.3	125	100	—	500	HV	
25Z6	Rectifier-Doubler	7-pin O.	7Q	Hr.	25	0.3	125	100	—	500	HV	
28Z5	Full-Wave Rectifier	8-pin L.	5AB	Hr.	28	0.24	450 <sup>7</sup> 325 <sup>4</sup>	100	—	300	HV	
32L7GT	Rectifier-Tetrode	8-pin O.	8Z	Hr.	32.5	0.3	125	60	—	—	HV	
35W4	Half-Wave Rectifier	7-pin B.	5BQ	Hr.	35 <sup>2</sup>	0.15	125	100 <sup>3</sup>	330	600	HV	
35Y4	Half-Wave Rectifier	8-pin O.	5AL	Hr.	35 <sup>1</sup>	0.15	235	60 100 <sup>8</sup>	700	600	HV	
35Z3	Half-Wave Rectifier	8-pin L.	4Z	Hr.	35	0.15	250 <sup>3</sup>	100	700	600	HV	
35Z4GT	Half-Wave Rectifier	6-pin O.	5AA	Hr.	35	0.15	250	100	700	600	HV	
35Z5G	Half-Wave Rectifier	6-pin O.	6AD	Hr.	35 <sup>2</sup>	0.15	125	60 100 <sup>8</sup>	—	—	HV	

Courtesy ARRL Handbook



# RECEIVING TUBE SUBSTITUTION GUIDE

## TABLE XV—RECTIFIERS—RECEIVING AND TRANSMITTING—Continued

See also Table XIII—Control and Regulator Tubes

Type No.	Name	Base	Socket Connections	Cathode	Fil. or Heater		Max. A.C. Voltage Per Plate	D.C. Output Current Ma.	Max. Inverse Peak Voltage	Peak Plate Current Ma.	Type
					Volts	Amp.					
35Z6G	Voltage Doubler	6-pin O.	7Q	Htr.	35	0.3	125	110	—	500	HV
40Z5GT	Half-Wave Rectifier	6-pin O.	6AD	Htr.	40 <sup>2</sup>	0.15	125	60 100 <sup>3</sup>	—	—	HV
45Z3	Half-Wave Rectifier	7-pin B.	5AM	Htr.	45	0.075	117	65	350	390	HV
45Z5GT	Half-Wave Rectifier	6-pin O.	6AD	Htr.	45 <sup>2</sup>	0.15	125	60 100 <sup>3</sup>	—	—	HV
50X6	Voltage Doubler	8-pin I.	7AJ	Htr.	50	0.15	117	75	700	450	HV
50Y6GT	Full-Wave Rectifier	7-pin O.	7Q	Htr.	50	0.15	125	85	—	—	HV
50Y7GT	Voltage Doubler	8-pin I.	8AN	Htr.	50 <sup>2</sup>	0.15	117	65	700	—	HV
50Z6G	Voltage Doubler	7-pin O.	7Q	Htr.	50	0.3	125	150	—	—	HV
50Z7G <sup>10</sup>	Voltage Doubler	8-pin O.	8AN	Htr.	50	0.15	117	65	—	—	HV
70A7GT	Rectifier-Tetrode	8-pin O.	8AB	Htr.	70	0.15	125 <sup>5</sup>	60	—	—	HV
70L7GT	Rectifier-Tetrode	8-pin O.	8AA	Htr.	70	0.15	117	70	—	350	HV
72	Half-Wave Rectifier	4-pin M.	4P	Fil.	2.5	3.0	—	30	20000	150	HV
73	Half-Wave Rectifier	8-pin O.	4Y	Fil.	2.5	4.5	—	20	13000	3000	HV
80	Full-Wave Rectifier	4-pin M.	4C	Fil.	5.0	2.0	350 <sup>4</sup> 500 <sup>7</sup>	125 125	1400	375	HV
81	Half-Wave Rectifier	4-pin M.	4B	Fil.	7.5	1.25	700	85	—	—	HV
82	Full-Wave Rectifier	4-pin M.	4C	Fil.	2.5	3.0	500	125	1400	400	MV
83	Full-Wave Rectifier	4-pin M.	4C	Fil.	5.0	3.0	500	250	1400	800	MV
83-V	Full-Wave Rectifier	4-pin M.	4AD	Htr.	5.0	2.0	400	200	1100	—	HV
84/6Z4	Full-Wave Rectifier	5-pin S.	5D	Htr.	6.3	0.5	350	60	1000	—	HV
117L7GT/ 117M7GT	Rectifier-Tetrode	8-pin O.	8AO	Htr.	117	0.09	117	75	—	—	HV
117N7GT	Rectifier-Tetrode	8-pin O.	8AV	Htr.	117	0.09	117	75	350	450	HV
117P7GT	Rectifier-Tetrode	8-pin O.	8AV	Htr.	117	0.09	117	75	350	450	HV
117Z3	Half-Wave Rectifier	7-pin B.	4BR	Htr.	117	0.04	117	90	330	—	HV
117Z4GT	Half-Wave Rectifier	6-pin O.	5AA	Htr.	117	0.04	117	90	330	—	HV
117Z6GT	Voltage Doubler	7-pin O.	7Q	Htr.	117	0.075	235	60	700	360	HV
217-A <sup>10</sup>	Half-Wave Rectifier	4-pin J.	4AT	Fil.	10	3.25	—	—	3500	600	HV
217-C	Half-Wave Rectifier	4-pin J.	4AT	Fil.	10	3.25	—	—	7500	600	HV
2225	Half-Wave Rectifier	4-pin M.	4P	Fil.	2.5	5.0	—	250	10000	1000	MV
249-B	Half-Wave Rectifier	4-pin M.	Fig. 53	Fil.	2.5	7.5	3180	375	10000	1500	MV
HK253	Half-Wave Rectifier	4-pin J.	4AT	Fil.	5.0	10	—	350	10000	1500	HV
705A RK-705A	Half-Wave Rectifier	4-pin W.	T-3AA	Fil.	2.5 <sup>1</sup> 5.0	5.0	—	50 100	35000 35000	375 750	HV
816	Half-Wave Rectifier	4-pin S.	4P	Fil.	2.5	2.0	2200	125	7500	500	MV
836	Half-Wave Rectifier	4-pin M.	4P	Htr.	2.5	5.0	—	—	5000	1000	HV
866A/866	Half-Wave Rectifier	4-pin M.	4P	Fil.	2.5	5.0	3500	250	10000	1000	MV
866B	Half-Wave Rectifier	4-pin M.	4P	Fil.	5.0	5.0	—	—	8500	1000	MV
866 Jr.	Half-Wave Rectifier	4-pin M.	4B	Fil.	2.5	2.5	1250	250 <sup>1</sup>	—	—	MV
HY866 Jr.	Half-Wave Rectifier	4-pin M.	4P	Fil.	2.5	2.5	1750	250 <sup>1</sup>	5000	—	MV
RK866	Half-Wave Rectifier	4-pin M.	4P	Fil.	2.5	5.0	3500	250	10000	1000	MV
871 <sup>10</sup>	Half-Wave Rectifier	4-pin M.	4P	Fil.	2.5	2.0	1750	250	5000	500	MV
878	Half-Wave Rectifier	4-pin M.	4P	Fil.	2.5	5.0	7100	5	20000	—	HV
879	Half-Wave Rectifier	4-pin S.	4P	Fil.	2.5	1.75	2650	7.5	7500	100	HV
872A/872	Half-Wave Rectifier	4-pin J.	4AT	Fil.	5.0	7.5	—	1250	10000	5000	MV
975A	Half-Wave Rectifier	4-pin J.	4AT	Fil.	5.0	10.0	—	1500	15000	6000	MV
OZ4A/ 1003	Full-Wave Rectifier	5-pin O.	4R	Cold	—	—	—	110	880	—	G
1005/ CK1005	Full-Wave Rectifier	8-pin O.	5AQ	Fil.	6.3	0.1	—	70	450	210	G
1006/ CK1006	Full-Wave Rectifier	4-pin M.	4C	Fil.	1.75	2.25	—	200	1600	—	G
CK1007	Full-Wave Rectifier	8-pin O.	T-9G	Fil.	1.0	1.2	—	110	980	—	G
CK1009/BA	Full-Wave Rectifier	4-pin M.	—	Cold	—	—	—	350	1000	—	G
1274	Full-Wave Rectifier	6-pin O.	6S	Htr.	6.3	0.6	—	—	—	—	HV
1275	Full-Wave Rectifier	4-pin M.	4C	Fil.	5.0	1.75	—	—	—	—	HV
1616	Half-Wave Rectifier	4-pin M.	4P	Fil.	2.5	5.0	—	130	6000	800	HV
1641/ RK60	Full-Wave Rectifier	4-pin M.	T-4AG	Fil.	5.0	3.0	—	50 250	4500 2500	—	HV
1654	Half-Wave Rectifier	7-pin B.	2Z	Fil.	1.4	0.05	2500	1	7000	6	HV
5517	Half-Wave Rectifier	7-pin B.	5BU	Cold	—	—	1200	6	—	50	G
5825	Half-Wave Rectifier	4-pin M.	4P	Fil.	1.6	1.25	—	2	60000	40	HV
8008	Half-Wave Rectifier	4-pin <sup>6</sup>	Fig. 11	Fil.	5.0	7.5	—	1250	10000	5000	MV
8013A	Half-Wave Rectifier	4-pin M.	4P	Fil.	2.5	5.0	—	20	40000	150	HV
8016	Half-Wave Rectifier	6-pin O.	4AC	Fil.	1.25	0.2	—	2.0	10000	7.5	HV
8020	Half-Wave Rectifier	4-pin M.	4P	Fil.	5.0 5.8	5.5 6.5	10000 12500	100	40000	750	HV
RK19	Full-Wave Rectifier	4-pin M.	4AT	Htr.	7.5	2.5	1250	200 <sup>4</sup>	3500	600	HV
RK21	Half-Wave Rectifier	4-pin M.	4P	Htr.	2.5	4.0	1250	200 <sup>4</sup>	3500	600	HV
RK22	Full-Wave Rectifier	4-pin M.	T-4AG	Htr.	2.5	8.0	1250	200 <sup>4</sup>	3500	600	HV

<sup>1</sup> With input choke of at least 20 henrys.

<sup>2</sup> Tapped for pilot lamps.

<sup>3</sup> Per pair with choke input.

<sup>4</sup> Condenser input.

<sup>5</sup> With 100 ohms min. resistance in series with plate; without series resistor, maximum r.m.s. plate rating is 117 volts.

<sup>6</sup> Same as 872A/872 except for heavy-duty push-type base.

Filament connected to pins 2 and 3, plate to top cap.

<sup>7</sup> Choke input.

<sup>8</sup> Without panel lamp.

<sup>9</sup> Using only one-half of filament.

<sup>10</sup> Discontinued.

# CATHODE-RAY TUBE BASES

**4AE**

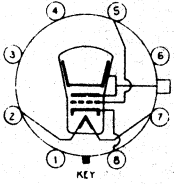

**4AF**

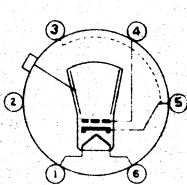

**5AJ**

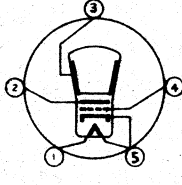

**5AN**

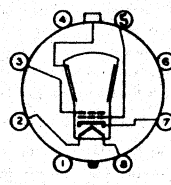

**5BP**

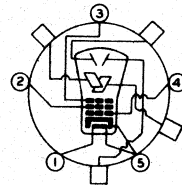

**5BR**

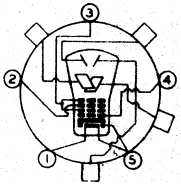

**5BV**

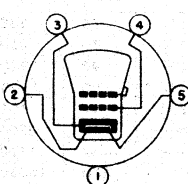

**5CC**

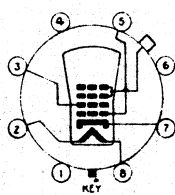

**6AL**

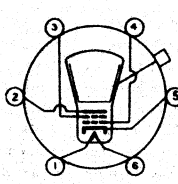

**6AZ**

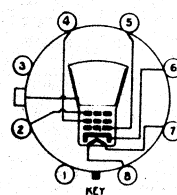

**6BF**

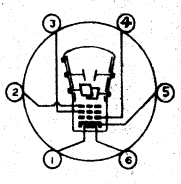

**6BN**

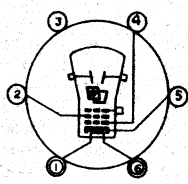

**6BV**

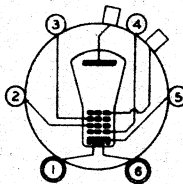

**7AN**

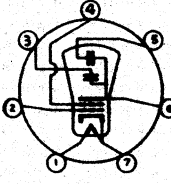

**7CE**

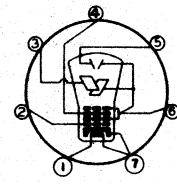

**8BP**

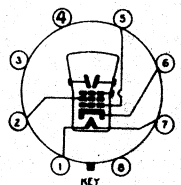

**8BQ**

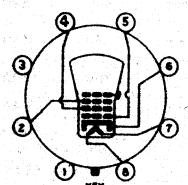

**8BR**

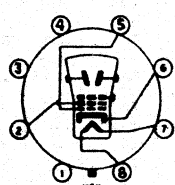

**8BX**

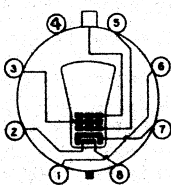

**8CD**

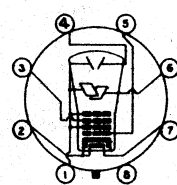

**9D**

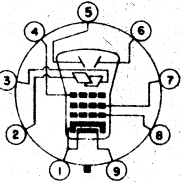

**11A**

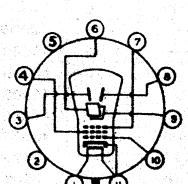

**11B**

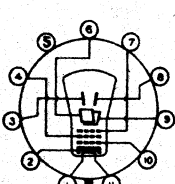

**11C**

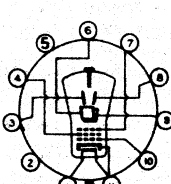

**11D**

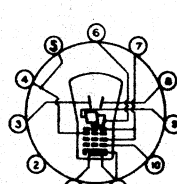

# RECEIVING TUBE SUBSTITUTION GUIDE

**11E**

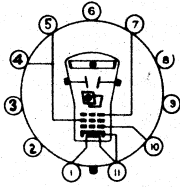

**11F**

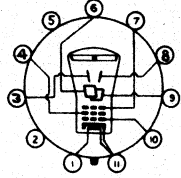

**11G**

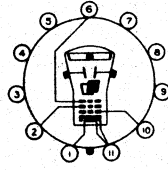

**11H**

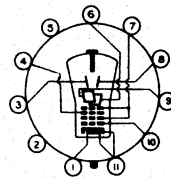

**11J**

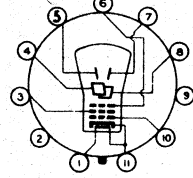

**11L**

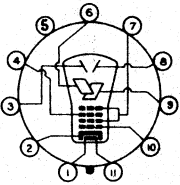

**11M**

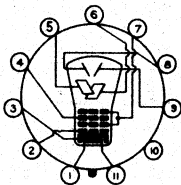

**11N**

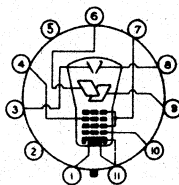

**11P**

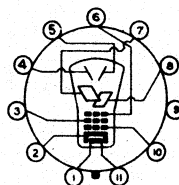

**11Q**

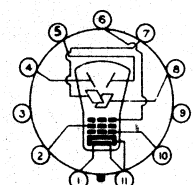

**11S**

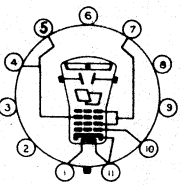

**11T**

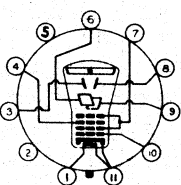

**12A**

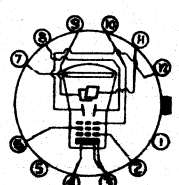

**12C**

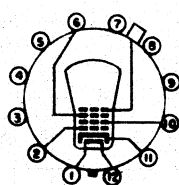

**12D**

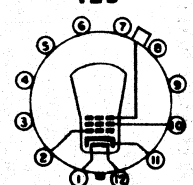

**12E**

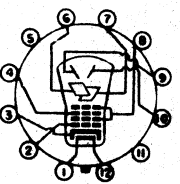

**12F**

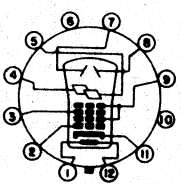

**12H**

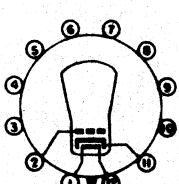

**14A**

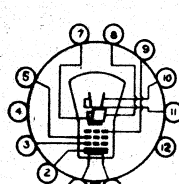

**14B**

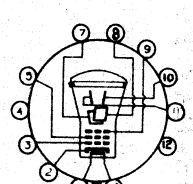

**14C**

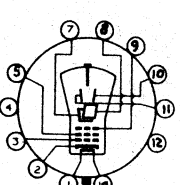

**14D**

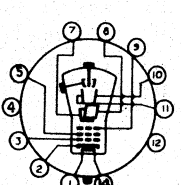

**14E**

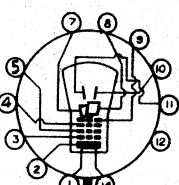

**14F**

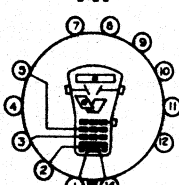

**14G**

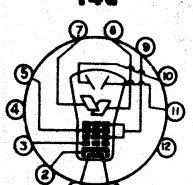

**14H**

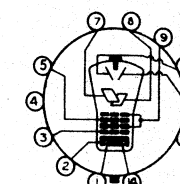

**14J**

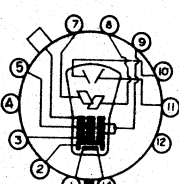

**14K**

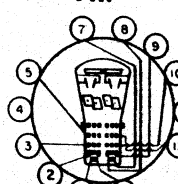

**14L**

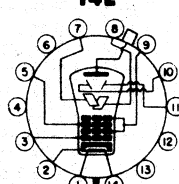

# RECEIVING TUBE SUBSTITUTION GUIDE

## CATHODE-RAY TUBE CHARACTERISTICS

### ELECTROSTATIC TYPES—CATHODE RAY TUBES

Type	Heater		Nominal Dimensions		Base	RHA Basing	Screen		Maximum Design Center Ratings				Typical Operating Conditions			
	Volts	Amperes	Diameter Inches	Length Inches			Fluorescence	Persistence	Anode #1 Volts	Anode #2 Volts	Anode #3 Deflection Peak Volts	Anode #2 to Deflection Peak Volts	Anode #1 Avg. Volts**	Anode #3 Grid Range Volts*	Avg. Volts DC/Inch	Deflection
														D 1-2	D 3-4	
2AP1 ) 2AP1A )	6.3	0.6	2	7-7/16	Small Shell Magnal 11 Pin	11B 11L	Medium	500	1000	.....	600	500	125	15-45 30-90	115	98
2BP1 ) 2BP1A )	6.3	0.6	2-1/16	7-5/8	Small Shell Duodecal 12 Pin	12F 12E	Medium	1000	2500	.....	500	1000	150-280	0-67.5 0-135	115-155 230-310	196
3AP1 ) 3AP1A ) 3AP4 )	2.5	2.1	3	11-1/2	Medium 7 Pin	7AN 7CE 7AN	Medium Medium White	1000	1500	.....	600	800	170	14-40 14-60 17-50 20-60 22.5-67.5	47 61 76 91 114	45
3BP1 ) 3BP1A )	6.3	0.6	3	10	Medium Shell Diheptal 12 Pin	14A 14A	Medium Medium	1000	2000	.....	500	1500	430	22.5-67.5 30-90	168	123
3CP1 ) 3CP1A )	6.3	0.6	3	10-3/8	Medium Magnal 11 Pin, Sleeve	11C	Medium	1000	2000	.....	500	1500	430	22.5-67.5 30-90	165.5	221
3DP1 ) 3DP1A )	6.3	0.6	3	10-7/16	Medium Shell Diheptal 12 Pin	14C 14H	Medium	1000	2000	.....	500	1500	430	22.5-67.5 30-90	166	123
3EP1 ) 3EP1A )	6.3	0.6	3	9-15/16	Large Wafer Magnal 11 Pin, Sleeve	11A	Medium	1000	2000	.....	500	1500	430	22.5-67.5 30-90	165.5	124
3FP7 ) 3FP7A )	6.3	0.6	3	10	Medium Shell Diheptal 12 Pin	14B 14J	Characteristics of Phosphor No. 1	1000	2000	4000	500	2000	575	20-30 22.5-67.5 30-90	221	164
3GP1 ) 3GP4 )	6.3	0.6	3	11-1/2	Medium Shell Magnal 11 Pin	11A	Medium White	1000	1500	.....	500	1000	234	16.5-49.5 25-75	80	70
3GP1A ) 3GP4A )	6.3	0.6	3	11-1/2	Medium Shell Magnal 11 Pin	11N 11N	Medium White	1000	1500	.....	550	1000	163-291	16.5-49.5 25-75	64-96 96-144	56-84
3JP1 ) 3JP1A )	6.3	0.6	3	10	Medium Shell Diheptal 12 Pin	14J 14J	Medium	1000	2000	4000	500	2000	430	22.5-67.5 30-90	120	89
3KP1 ) 3KP4 )	6.3	0.6	3	11-1/2	Medium Shell Magnal 11 Pin	11M 11M	Medium White	1000	2500	.....	500	2000	320-600	0-45 0-90	50-68 100-136	38-52 76-104
3MP1 ) 3MP1A )	6.3	0.6	3	8	Small Shell Duodecal 12 Pin	12F	Medium	1000	2500	.....	500	2000	200-350	0-63 0-126	140-190 280-380	130-180 260-360
3NP1 ) 3NP1A )	6.3	0.3	2-3/4	6-1/8	European 9 Pin	9D	Medium	700	1500	.....	550	2000	200-320	21-50 31-74	143-193 214-290	89-121 133-181
3BP1 ) 3BP1A )	6.3	0.6	3	9-1/8	Small Shell Duodecal 12 Pin	12F	Medium	1000	2500	.....	500	1000	165-310	67.5 13.5	85	122
3SP1 ) 3SP4 )	6.3	0.6	3x1-1/2	9-1/8	Small Shell Duodecal 12 Pin	12E	Medium White	1100	2750	.....	...	2000	330-620	28.5-67.5 58-135	73-99 146-198	52-70 104-140
5AP1 ) 5AP4 )	6.3	0.6	5-1/4	13	Large Wafer Magnal 11 Pin, Sleeve	11A	Medium	1200	2000	.....	500	1500	430	31-57 40-74	93	90
5BP1 ) 5BP4 )	6.3	0.6	5-1/4	13	Large Wafer Magnal 11 Pin, Sleeve	11A	White	1200	2000	.....	500	1500	430	17.6-57 22.8-74	93	90
5DP1 ) 5DP4 )	6.3	0.6	5-1/4	16-3/4	Large Wafer Magnal 11 Pin	11A	Medium White	1000	2000	.....	500	1500	310	20-60	63	57
5EP1A ) 5EP7A )	6.3	0.6	5-1/4	16-3/4	Medium Shell Magnal 11 Pin	11N	Medium	1000	2000	.....	500	1500	337-450	15-45 20-60	63	57
5FP7A )	6.3	0.6	5-1/4	16-3/4	Medium Shell Magnal 11 Pin	11N	Characteristics of P7 Screen	1000	2000	.....	500	1500	235-420 315-560	15-45 20-60	52-74 70-98	63-89

\* Cut-off voltage. Supply should be adjustable from 0 to value shown.  
 \*\* Bogen value for focus. Voltage should be adjustable about value shown.  
 Commonly used Phosphors only listed. Courtesy Sylvania Electric Products Inc.

# RECEIVING TUBE SUBSTITUTION GUIDE

## ELECTROSTATIC TYPES—CATHODE RAY TUBES

Type	Heater		Nominal Dimensions		Base	RVA Basing	Screen		Maximum Design Center Ratings			Typical Operating Conditions			
	Volts	Amperes	Diameter Inches	Length Inches			Fluorescence	Persistence	Anode #1 Volts	Anode #2 Volts	Anode #3 Deflection Plate Peak Volts	Anode #2 to Deflection Plate Peak Volts	Anode #1 Avg. Volts**	Anode #2 Volts	Anode #3 Grid Range Volts*
5CP1	6.3	0.6	5-1/4	16-3/4	Medium Shell Diheptal 12 Pin	14B	Green	Medium	1000	2000	4000	500	2000	30-90	73
5CP4	6.3	0.6	5-1/4	16-3/4	Medium Shell Diheptal 12 Pin	14B	White	Medium	1000	2000	4000	500	2000	22.5-67.5	64
5CP1A	6.3	0.6	5-1/4	16-3/4	Medium Shell Diheptal 12 Pin	14J	Green	Medium	1000	2000	4000	500	2000	30-90	92
5CP1	6.3	0.6	5-1/4	16-3/4	Large Wafer Magnal 11 Pin, Sleeve	11A	Green	Medium	1000	2000	4000	500	2000	24-56	72
5RP1	6.3	0.6	5-1/4	16-3/4	Large Wafer Magnal 11 Pin, Sleeve	11A	Green	Medium	1000	2000	4000	500	1500	15-45	63.5
5RP4	6.3	0.6	5-1/4	16-3/4	Large Wafer Magnal 11 Pin, Sleeve	11A	White	Medium	1000	2000	4000	500	2000	20-60	84.8
5RP1A	6.3	0.6	5-1/4	16-3/4	Large Wafer Magnal 11 Pin, Sleeve	11N	Green	Medium	1000	2000	4000	500	1500	15-45	63
5RP4	6.3	0.6	5-5/16	16-3/4	Medium Magnal 11 Pin	11F	Green	Medium	1000	2000	4000	500	2000	20-60	84
5RP4A	6.3	0.6	5-5/16	16-3/4	Medium Magnal 11 Pin	11S	White	Medium	1000	2000	4000	500	2000	45-105	96
5LP1	6.3	0.6	5-5/16	16-3/4	Medium Magnal 11 Pin, Sleeve	11F	Green	Medium	1000	2000	4000	500	1000	15-45	52
5LP4	6.3	0.6	5-5/16	16-3/4	Medium Magnal 11 Pin, Sleeve	11F	White	Medium	1000	2000	4000	500	1500	22.5-67.5	77
5LP1A	6.3	0.6	5-5/16	16-3/4	Medium Magnal 11 Pin, Sleeve	11T	Green	Medium	1000	2000	4000	550	1500	30-90	103
5LP4A	2.5	2.1	5-5/16	15-7/8	Large 7 Pin	7AN	Green	Medium	1000	1500	4000	600	2000	16.5-49.5	66
5NP1	6.3	0.6	5-5/16	16-3/4	Large Wafer Magnal 11 Pin, Sleeve	7AN	Green	Medium	1000	2000	4000	500	1500	15-45	84
5NP4	6.3	0.6	5-1/4	16-3/4	Medium Shell Diheptal 12 Pin	14F	Green	Medium	15550	3500	25500	1200	2000	30-90	30-45
5RP1	6.3	0.6	5-1/4	16-3/4	Medium Shell Diheptal 12 Pin	14F	White	Medium	15550	3500	25500	1200	2000	30-90	36-54
5RP4	6.3	0.6	5-1/4	16-3/4	Medium Shell Diheptal 12 Pin	14F	Green	Medium	15550	3500	25500	1200	2000	30-90	30-45
5RP1A	6.3	0.6	5-1/4	18-1/2	Medium Shell Diheptal 12 Pin	14K	Green	Medium	1000	2000	4000	500	1500	22.5-67.5	55
5RP4A	6.3	0.6	5-1/4	18-1/2	Medium Shell Diheptal 12 Pin	14K	White	Medium	1000	2000	4000	500	1500	22.5-67.5	48
5SP1	6.3	0.6	5-1/4	14-3/4	Small Shell Duodecal 12 Pin	12E	Green	Medium	1000	2500	4000	500	1000	22.5-67.5	69
5SP7	6.3	0.6	5-1/4	16-3/4	Medium Shell Magnal 11 Pin	11N	Green	Medium	1000	2500	4000	500	1000	22.5-67.5	28-31
5XP1	6.3	0.6	5-1/4	17-5/8	Medium Shell Diheptal 12 Pin	14F	Green	Medium	1550	3500	25500	1200	2000	30-90	72-108
7BP4	6.3	0.6	7	15-1/2	Medium Shell Magnal 11 Pin	11N	White	Medium	1500	3300	4000	700	2500	36-84	110
7BP4	6.3	0.6	7	14-1/2	Medium Shell Diheptal 12 Pin	14G	White	Medium	1500	4000	4000	500	3000	36-84	93-123
7JP1	6.3	0.6	7	14-1/2	Medium Shell Diheptal 12 Pin	14G	Green	Medium	2800	6000	6000	750	6000	72-168	150-204
7JP4	6.3	0.6	8-3/4	16-1/2	Medium Shell Diheptal 12 Pin	14G	White	Medium	3100	6600	6000	750	6000	186-246	124-198
9NP1	2.5	2.1	9	21	Medium 6 Pin	6RN	Green	Medium	1500	5500	5000	1500	5000	45-135	190

\* Cut-off voltage. Supply should be adjustable from 0 to value shown.

\*\* Bogey value for focus. Voltage should be adjustable about value shown.

Courtesy Sylvania Electric Products Inc.

# RECEIVING TUBE SUBSTITUTION GUIDE

## ELECTROSTATIC TYPES—CATHODE RAY TUBES

Type	Heater		Nominal Dimensions		Base	RNA Basing	Screen†		Maximum Design Center Ratings				Typical Operating Conditions				
	Volts	Amperes	Diameter Inches	Length Inches			Fluorescence	Persistence	Anode #1 Volts	Anode #2 Volts	Anode #3 Deflection Plate Peak Volts	Anode #2 to #3 Deflection Plate Peak Volts	Anode #2 Volts	Anode #1 Avg. Volts**	Anode #3 Volts	Grid Range Volts*	Deflection Avg. Volts DC/Inch
10CP4	6.3	0.6	10	18-1/2	Medium Shell Dileptal 12 Pin	14G	White	Medium	2000	5000	500	4500	1130-1660	4000	54-126	112-149	
10IP4	6.3	0.6	10	19-1/4	Medium Shell Dileptal 12 Pin	14G	White	Medium	2000	5000	600	4000	960-1440	4000	48-112	125-165	
12FP7	6.3	0.6	12	24	Medium Shell Dileptal 12 Pin	14F	Characteristics of Phosphor No. 7	Characteristics of Phosphor No. 7	2000	4000	1000	2000	1200-1800	4000	60-140	88-120	
12CP7	6.3	0.6	12	22	Medium Shell Dileptal 12 Pin	14B	Characteristics of Phosphor No. 7	Characteristics of Phosphor No. 7	2000	4000	1000	3000	857	4000	49-147	68-92	
12HP1	6.3	0.6	12	23-1/2	Medium Magnal 11 Pin, Sleeve	11J	Green	Medium	1500	5500	1000	5000	1150 +2% -30%	4000	45-135	85-115	
14AP1	2.5	2.1	13-3/8	24-1/4	12 Pin Peripheral Contact	12A	Green	Medium	1800	4000	8000	2000	500	4000	20-60	65	
20AP4	2.5	2.1	20	27-7/8	12 Pin Peripheral Contact	12A	Green	Medium	1800	4000	8000	2000	500	4000	20-60	55	
902	6.3	0.6	2	7-1/2	Medium Shell Octal 8 Pin	8CD	Green	Medium	300	600	347	400	100	4000	20-60	93	
902-A	6.3	0.6	2	7-7/16	Medium Shell Octal 8 Pin	8CD	Green	Medium	300	600	347	400	100	4000	20-60	78	
905	2.5	2.1	5-1/4	16-1/2	Long Shell Medium 5 Pin Micanol	5BP 5BP 5BP	Green Bluish-White	Medium Very Short Long	600	2000	1000	1500	338	4000	13-39	86	
905-A	2.5	2.1	5-1/4	16-1/2	Long Shell Medium 5 Pin Micanol	5BR	Green	Medium	600	2000	1000	1500	450	4000	17.5-52.5	97	
908	2.5	2.1	3	11-1/2	Medium 7 Pin	7AN 7AN	Bluish-White	Very Short Long	1000	1500	600	600	170	4000	46.3	44	
908-A	2.5	2.1	3	11-1/2	Medium 7 Pin	7CE	Blue	Very Short	1000	1500	500	1000	287	4000	16.5-49.5	76	
912	2.5	2.1	5-1/4	16-1/2	Medium 5 Pin Micanol	912	Green	Medium	4500	1500	7000	5000	1000	4000	27-81	306	
913	6.3	0.6	1-5/8	4-3/4	Small Wafer Octal 8 Pin	913	Green	Medium	200	500	250	250	50	4000	31-93	620	
914	2.5	2.1	9-1/4	21-1/2	Medium 6 Pin	6BF	Green	Medium	1900	7000	3000	1500	300	4000	35-105	910	
914A	2.5	2.1	9-1/4	20-1/16	Medium 6 Pin	914A	Green	Medium	1000	7000	3000	1500	300	4000	25-75	75	
VCR 139A	4.0	1.1	2-3/4	7-7/8	European	VCR 139A	Green	Medium	1000	1000	800	800	120-150	4000	7-16	104	

\* Cut-off voltage. Supply should be adjustable from 0 to value shown.

\*\* Polex value for focus. Voltage should be adjustable about value shown.

Courtesy Sylvania Electric Products Inc.

# RECEIVING TUBE SUBSTITUTION GUIDE

## MAGNETIC TYPE CATHODE RAY TUBES

Type No.	Heater		Bulb							Ion Trap Required	Base	RMA Housing	µuf. Filter Capacitance Provided by Bulb Coating	Deflection and Focusing Method	Maximum Design Center Ratings		Typical Operation		
	Volts	Amperes	Nominal Dimensions in Inches	Length Inches	Construction	Terminal	Face Plate Color	Deflection Angle in Degrees (Note 1)	Anode Volts						Accelerator Grid Volts	Anode Volts	Accelerator Grid Volts	Control Grid Negative Volts	Type No.
3BP7	6.3	0.6	3 Diam.	9-13/16	Glass	Snap	Clear	55	None	Medium Shell Octal 8 Pin	5AN	None	Magnetic	5000	200	4000	150	15-45	3BP7
3BP4	6.3	0.6	2-9/16 Diam.	10	Glass	Recessed Small Ball	Clear	42	None	Special 5 Pin	3BP4	275 Min, 375 Max.	Magnetic	25000	...	24000	...	60	3BP4
5FP4A	6.3	0.6	5 Diam.	11-1/8	Glass	Recessed Small Ball	Clear	53	None	Medium Shell Octal 8 Pin	8BX	None	Magnetic	8000	300	6000	250	45	5FP4A
5FP7A	6.3	0.6	5 Diam.	11-1/2	Glass	Recessed Small Ball	Clear	53	None	Medium Shell Octal 8 Pin	8BX	None	Magnetic	8000	700	4000	250	25-70	5FP7A
5FP7	6.3	0.6	5 Diam.	11-1/8	Glass	Snap	Clear	55	None	Small Wafer Octal 8 Pin with Sleeve	5AN	None	Magnetic	7000	300	4000	250	25-75	5FP7
5FP14	6.3	0.6	5 Diam.	11-1/8	Glass	Snap	Clear	55	None	Small Wafer Octal 8 Pin with Sleeve	5AN	None	Magnetic	7000	700	4000	250	25-75	5FP14
5TP4	6.3	0.6	5 Diam.	11-3/4	Glass	Recessed Small Cavity	Clear	50	None	Medium Shell Duodecal 12 Pin	12C1	100 Min, 500 Max.	Note 2	27000	350	27000	200	70	5TP4
5MP15	6.3	0.6	5 Diam.	11-7/16	Glass	Recessed Small Cavity	Clear	50	None	Small Shell Duodecal 7 Pin	12C1	100 Min, 500 Max.	Note 2	27000	350	20000	200	70	5MP15
7AP4	2.5	2.1	7-1/8 Diam.	13-1/2	Glass	None	Clear	55	None	Medium 5 Pin	5AJ	None	Note 2	35000	No Grid	35000	No Grid	67.5	7AP4
7BP1	6.3	0.6	7 Diam.	13-1/4	Glass	Snap	Clear	55	None	Octal 8 Pin with Sleeve	5AN	None	Magnetic	7000	675	4000	250	90	7BP1
7BP7	6.3	0.6	7 Diam.	13-1/4	Glass	Snap	Clear	55	None	Octal 8 Pin with Sleeve	5AN	None	Magnetic	7000	300	4000	250	50	7BP7
7BP7A	6.3	0.6	7 Diam.	13-1/4	Glass	Recessed Small Ball	Clear	53	None	Medium Shell Octal 8 Pin	8BX	None	Magnetic	8000	700	4000	250	25-70	7BP7A
7CP1	6.3	0.6	7 Diam.	13-7/16	Glass	Snap	Clear	57	None	Medium Shell Octal 8 Pin	6AZ	None	Note 2	8000	300	4000	250	45	7CP1
7CP4	6.3	0.6	7 Diam.	13-7/16	Glass	Recessed Small Ball	Clear	57	None	Medium Shell Octal 8 Pin	6AZ	None	Note 2	8000	300	6000	250	45	7CP4
7DP4	6.3	0.6	7-3/16 Diam.	14-1/16	Glass	Recessed Small Cavity	Clear	50	Double	Small Shell Duodecal 7 Pin	12C2	400 Min, 1500 Max.	Note 2	8000	410	6000	250	45	7DP4
7RP4	6.3	0.6	7-3/16 Diam.	13	Glass	Recessed Small Ball	Clear	50	None	Small Shell Duodecal 7 Pin	12D2	500 Max.	Magnetic	8000	410	6000	250	33-77	7RP4
8AP4	6.3	0.6	8-1/2 Diam.	14-1/4	Metal	Cone Lip	Clear	54	Single	Small Shell Duodecal 7 Pin	12H	None	Magnetic	10000	No Grid	9000	No Grid	27-63	8AP4
8AP4A	6.3	0.6	8-1/2 Diam.	14-1/4	Metal	Cone Lip	Gray	54	Single	Small Shell Duodecal 5 Pin	12H	None	Magnetic	9000	No Grid	7000	No Grid	27-63	8AP4A
9AP4	2.5	2.1	9-1/8 Diam.	21	Glass	Cap	Clear	40	None	Medium 6 Pin	6AL	None	Note 2	7000	250	6000	250	25	9AP4
9CP4	2.5	2.1	9 Diam.	15-7/8	Glass	Cap	Clear	...	None	6 Pin Base	4AF	None	Magnetic	7000	No Grid	6000	No Grid	90	9CP4
9GP7	6.3	0.6	9 Diam.	17	Glass	Cap	Clear	55	None	Octal 8 Pin with Sleeve	5AN	None	Magnetic	7000	300	4000	250	45	9GP7
9JP1	2.5	2.1	9 Diam.	15-11/16	Glass	Snap	Clear	55	None	Small Wafer Octal 8 Pin with Sleeve	8BF	None	Note 3	5000	No Grid	2500	No Grid	45	9JP1
9LP7	6.3	0.6	9 Diam.	14-31/32	Glass	Cap	Clear	55	None	Octal 8 Pin with Sleeve	5AN	None	Magnetic	7000	300	4000	250	55-105	9LP7
9MP7	6.3	0.6	9 Diam.	17-1/2	Glass	Cap	Clear	55	None	Octal 8 Pin with Sleeve	5AN	None	Magnetic	7000	300	4000	250	25-75	9MP7
10BP4	6.3	0.6	10-1/2 Diam.	17-5/8	Glass	Recessed Small Cavity	Clear	50	Double	Small Shell Duodecal 7 Pin	12D2	500 Min, 2500 Max.	Magnetic	10000	410	9000	250	20-60	10BP4
10BP4A	6.3	0.6	10-1/2 Diam.	16-5/8	Glass	Recessed Small Ball	Gray	50	None	Small Shell Duodecal 7 Pin	12D2	500 Max.	Magnetic	11000	410	8000	250	30-66	10BP4A
10CP4	6.3	0.6	10-1/2 Diam.	16-5/8	Glass	Recessed Small Ball	Clear	50	None	Small Shell Duodecal 7 Pin	12D2	500 Max.	Magnetic	11000	410	8000	250	30-66	10CP4

Courtesy Sylvania Electric Products Inc.



## RECEIVING TUBE SUBSTITUTION GUIDE

### MAGNETIC TYPE CATHODE RAY TUBES

Type No.	Heater		Bulb							Ion Trap Required	Base	RMA Heating	Waf. Filter Characteristics Provided by Bulb Constr.	Deflection and Focusing Method	Maximum Design Center Ratings		Typical Operation			Type No.	
	Volts	Amperes	Nominal Face Dimensions in Inches	Length in Inches	Construction	Terminal	Face Plate Color	Deflection Angle in Degrees (Note 2)	Acce-lerator Grid Volts						Acce-lerator Grid Volts	Control Grid Negative Volts	Acce-lerator Grid Volts	Acce-lerator Grid Volts	Control Grid Negative Volts		
10DP4	6.3	0.6	10-1/2 Diam.	17-5/8	Glass	Recessed Small Cavity	Clear	50	None	Small Shell Duodecal 7 Pin	12C3	None	Note 2	Note 2	10000	410	9000	250	36-84	10DP4	
10EP4	6.3	0.6	10-1/2 Diam.	17-5/8	Glass	Snap	Clear	50	Double	Small Shell Duodecal 7 Pin	12P2	.....	Magnetic	Magnetic	11000	330	8000	250	20-65	10EP4	
10FP4	6.3	0.6	10-1/2 Diam.	17-5/8	Glass	Recessed Small Cavity	Clear	50	None	Small Shell Duodecal 7 Pin	12C1	500 Min, 2500 Max.	Magnetic	Magnetic	10000	410	9000	250	27-63	10FP4	
10KP7	6.3	0.6	10-1/2 Diam.	17-5/8	Glass	Recessed Small Cavity	Clear	50	None	Small Shell Duodecal 7 Pin	12D1	None	None	Magnetic	Magnetic	10000	700	7000	250	27-63	10KP7
10MP4	6.3	0.6	10-1/2 Diam.	17	Glass	Recessed Small Cavity	Clear	52	Double	Small Shell Duodecal 3 Pin	12C	500 Min, 2500 Max.	Magnetic	Magnetic	10000	No Grid	9000	No Grid	27-63	10MP4	
10MP4A							Gray														10MP4A
12AP4	2.5	2.1	12-1/16 Diam.	25-3/8	Glass	Cap	Clear	40	None	Medium 6 Pin	6AL	None	Note 2	Note 2	7000	250	6000	250	75	12AP4	
12CP4	2.5	2.1	12-1/16 Diam.	18-5/8	Glass	Cap	Clear	...	None	6 Pin Base	4AF	None	Magnetic	Magnetic	7000	No Grid	6000	No Grid	90	12CP4	
12DP7	6.3	0.6	12 Diam.	20-3/4	Glass	Medium Cap	Clear	55	None	Small Wafer Octal 8 Pin with Sleeve	5AN	None	Magnetic	Magnetic	7000	300	4000	250	25-75	12DP7	
12DP7A	6.3	0.6	12 Diam.	19-5/8	Glass	Medium Cap	Clear	50	None	Medium Shell Octal 8 Pin	61W	None	Magnetic	Magnetic	10000	700	4000	250	25-70	12DP7A	
12JP4	6.3	0.6	12 Diam.	17-1/2	Glass	Snap	Clear	50	None	Small Shell Duodecal 7 Pin	12D1	None	Magnetic	Magnetic	12000	410	10000	250	27-63	12JP4	
12KP4	6.3	0.6	12-7/16 Diam.	17-5/8	Glass	Recessed Small Cavity	Clear	54	None	Small Shell Duodecal 7 Pin	12D2	500 Min, 2500 Max.	Magnetic	Magnetic	12000	410	10000	250	27-63	12KP4	
12KPA4	6.3	0.6	12-7/16 Diam.	17-5/8	Glass	Recessed Small Cavity	Gray	54	None	Small Shell Duodecal 5 Pin	12D2	500 Min, 2500 Max.	Magnetic	Magnetic	12000	410	11000	250	27-63	12KPA4	
12LP4	6.3	0.6	12-7/16 Diam.	18-3/4	Glass	Recessed Small Cavity	Clear	54	Double	Small Shell Duodecal 5 Pin	12D2	750 Min, 3000 Max.	Magnetic	Magnetic	12000	410	11000	250	27-63	12LP4	
12LP4A							Gray														12LP4A
12OP4	6.3	0.6	12-7/16 Diam.	17-1/2	Glass	Recessed Small Ball Cap	Clear	55	Single	Small Shell Duodecal 7 Pin	12D1	None	Magnetic	Magnetic	12000	410	10000	250	27-63	12OP4	
12QPA4							Gray														12QPA4
12RP4	6.3	0.6	12 Diam.	17-1/2	Glass	Recessed Small Ball Cap	Clear	56	Single	Small Shell Duodecal 7 Pin	12D2	.....	Magnetic	Magnetic	12000	410	10000	250	27-63	12RP4	
12SP7	6.3	0.6	12-7/16 Diam.	18-3/4	Glass	Recessed Small Cavity	Clear	55	None	Small Shell Duodecal 7 Pin	12D1	None	Magnetic	Magnetic	10000	410	9000	250	27-63	12SP7	
12TP4	6.3	0.6	12-7/16 Diam.	18-3/4	Glass	Recessed Small Cavity	Clear	54	Double	Small Shell Duodecal 7 Pin	12D1	None	Magnetic	Magnetic	12000	410	11000	250	27-63	12TP4	
12UP4	6.3	0.6	12-7/16 Diam.	18-5/8	Metal	Cone Lip	Clear	54	Double	Small Shell Duodecal 7 Pin	12D3	None	Magnetic	Magnetic	12000	410	11000	250	27-63	12UP4	
12VP4A							Gray														12VP4A
12VP4B							Gray														12VP4B
12VP4	6.3	0.6	12-3/8 Diam.	18	Glass	Recessed Small Cavity	Clear	55	Double	Small Shell Duodecal 6 Pin	12D	750 Min, 3000 Max.	Magnetic	Magnetic	12000	No Grid	11000	No Grid	33-77	12VP4	
12VP4A							Gray														12VP4A
14BP4	6.3	0.6	12-1/2 x 9-11/16	16-13/16	Glass	Recessed Small Cavity	Gray	65	Double	Small Shell Duodecal 9 Pin	12D2	500 Min, 2000 Max.	Magnetic	Magnetic	12000	410	11000	250	27-63	14BP4	
14CP4	6.3	0.6	12-1/2 x 9-11/16	16-3/4	Glass	Recessed Small Cavity	Gray	65	Double	Small Shell Duodecal 6 Pin	12D2	1500	Magnetic	Magnetic	14000	410	12000	300	33-77	14CP4	
14DP4	6.3	0.6	12-1/2 x 9-11/16	16-3/4	Glass	Recessed Small Cavity	Gray	65	Double	Small Shell Duodecal 5 Pin	12D1	None	Magnetic	Magnetic	14000	410	11000	250	27-63	14DP4	
15AP4	6.3	0.6	15-1/2 Diam.	20-1/2	Glass	Recessed Small Ball	Clear	52	None	Small Shell Duodecal 7 Pin	12C	None	Magnetic	Magnetic	15000	410	12000	250	27-63	15AP4	
15CP4	6.3	0.6	15-1/2 Diam.	21-1/2	Glass	Recessed Small Cavity	Clear	57	Double	Small Shell Duodecal 7 Pin	12D1	None	Magnetic	Magnetic	15000	410	9000	250 +	45	15CP4	

Courtesy Sylvania Electric Products Inc.



## RECEIVING TUBE SUBSTITUTION GUIDE

### MAGNETIC TYPE CATHODE RAY TUBES

Type No.	Heater		Bulb						Ion Trap Required	Base	RMA Beaming	Waf Filters Replaced by Bulb Containing	Deflection and Focusing Method	Maximum Design Center Ratings		Typical Operation		Type No.		
	Volts	Amperes	Nominal Face Dimensions in Inches	Length in Inches	Construction	Terminal	Face Plate Color	Deflection Angle in Degrees (Note 1)						Accelerator Anode Volts	Control Grid Negative Volts	Accelerator Anode Volts	Control Grid Negative Volts			
16DP4	6.3	0.6	15-1/2 Diam.	20-1/2	Glass	Recessed Small Ball Cap	Clear	57	Double	Small Shell Duodecal 5 Pin	12D1	None	Magnetic	15000	410	13000	250	27-63	16DP4	
16AP4	6.3	0.6	15-7/8 Diam.	22-5/16	Metal	Cone Lip	Clear	53	Double	Small Shell Duodecal 5 Pin	12D3	None	Magnetic	14000	410	9000	300	33-77	16AP4	
16AP4A							Gray													16AP4A
16CP4	6.3	0.6	15-7/8 Diam.	21-1/2	Glass	Recessed Small Cavity	Clear	52	Double	Small Shell Duodecal 7 Pin	12D1	None	Magnetic	15000	410	12000	250	27-63	16CP4	
16DP4	6.3	0.6	15-7/8 Diam.	20-3/4	Glass	Recessed Small Cavity	Clear	60	Double	Small Shell Duodecal 7 Pin	12D1	None	Magnetic	15000	410	9000	250	45	16DP4	
16DP4A							Gray													16DP4A
16FP4	6.3	0.6	15-7/8 Diam.	19-5/8	Metal	Cone Lip	Clear	60	Double	Small Shell Duodecal 5 Pin	12D3	None	Magnetic	14000	410	12000	300	33-77	16FP4	
16EP4A							Gray													16EP4A
16FP4	6.3	0.6	16-1/8 Diam.	20-1/4	Glass	Recessed Small Ball Cap	Clear	62	Single	Small Shell Duodecal 7 Pin	12D1	None	Magnetic	16000	410	13000	250	27-63	16FP4	
16GP4	6.3	0.6	15-7/8 Diam.	17-11/16	Metal	Cone Lip	Clear	70	Single	Small Shell Duodecal 5 Pin	12D3	None	Magnetic	14000	410	12000	300	33-77	16GP4	
16HP4	6.3	0.6	15-7/8 Diam.	21-1/4	Glass	Recessed Small Cavity	Clear	60	Double	Small Shell Duodecal 5 Pin	12D2	1500 Min., 3500 Max.	Magnetic	14000	410	12000	300	33-77	16HP4	
16HP4A							Gray													16HP4A
16JP4	6.3	0.6	16-1/8 Diam.	20-3/4	Glass	Recessed Small Cavity	Clear	60	Double	Small Shell Duodecal 5 Pin	12D2	750 Min., 2000 Max.	Magnetic	14000	410	11000	250	27-63	16JP4	
16JP4A							Gray													16JP4A
16KP4	6.3	0.6	14-3/4 x 11-1/2	18-3/4	Glass	Recessed Small Cavity	Clear	65	Single	Small Shell Duodecal 5 Pin	12D2	1500	Magnetic	16000	410	14000	300	33-77	16KP4	
16LP4	6.3	0.6	15-7/8 Diam.	22-1/4	Glass	Recessed Small Cavity	Clear	52	Double	Small Shell Duodecal 5 Pin	12D2	1500 Min., 3500 Max.	Magnetic	14000	410	12000	300	33-77	16LP4	
16LP4A							Gray													16LP4A
16MP4	6.3	0.6	16-1/8 Diam.	21-3/4	Glass	Recessed Small Cavity	Clear	60	Double	Small Shell Duodecal 5 Pin	12D2	1500 Min., 3500 Max.	Magnetic	14000	410	12000	300	33-77	16MP4	
16MP4A							Gray													16MP4A
16OP4	6.3	0.6	14-3/4 x 11-17/32	19-1/4	Glass	Recessed Small Cavity	Gray	65	Double	Small Shell Duodecal 7 Pin	12D1	None	Magnetic	16000	410	8000	250	27-63	16OP4	
16PP4	6.3	0.6	14-3/4 x 11-1/2	18-3/4	Glass	Recessed Small Cavity	Gray	65	Single	Small Shell Duodecal 5 Pin	12D2	1500	Magnetic	16000	410	12800	300	33-77	16PP4	
16SP4	6.3	0.6	15-7/8 Diam.	17-5/16	Glass	Recessed Small Cavity	Clear	70	Double	Small Shell Duodecal 5 Pin	12D2	1500 Min., 3500 Max.	Magnetic	14000	410	12000	300	33-77	16SP4	
16SP4A							Gray													16SP4A
16TP4	6.3	0.6	16-1/8 Diam.	18-1/8	Glass	Recessed Small Cavity	Gray	70	Single	Small Shell Duodecal 5 Pin	12D2	1500	Magnetic	14000	410	12000	300	33-77	16TP4	
16UP4	6.3	0.6	14-3/4 x 11-1/2	18-1/8	Glass	Recessed Small Cavity	Gray	65	Single	Small Shell Duodecal 5 Pin	12D1	None	Magnetic	15000	410	12000	300	27-63	16UP4	
16VP4	6.3	0.6	15-7/8 Diam.	17-3/16	Glass	Recessed Small Cavity	Gray	70	Single	Small Shell Duodecal 5 Pin	12D1	None	Magnetic	15000	410	12000	250	27-63	16VP4	
16WP4	6.3	0.6	15-7/8 Diam.	17-3/4	Glass	Recessed Small Cavity	Gray	70	Double	Small Shell Duodecal 5 Pin	12D1	None	Magnetic	15000	410	12000	250	27-63	16WP4	
16XP4	6.3	0.6	14-3/4 x 11-17/32	18-3/4	Glass	Recessed Small Cavity	Gray	65	Double	Small Shell Duodecal 5 Pin	12D1	None	Magnetic	15000	410	12000	250	27-63	16XP4	
16YP4	6.3	0.6	15-7/8 Diam.	17-5/16	Glass	Recessed Small Cavity	Gray	70	Single	Small Shell Duodecal 5 Pin	12D2	750 Min., 2000 Max.	Magnetic	14000	410	12000	300	33-77	16YP4	
19AP4	6.3	0.6	18-5/8 Diam.	21-1/2	Metal	Cone Lip	Clear	66	Single	Small Shell Duodecal 7 Pin	12D3	None	Magnetic	19000	410	13000	250	27-63	19AP4	
19AP4A							Gray													19AP4A

Courtesy Sylvania Electric Products Inc.

## RECEIVING TUBE SUBSTITUTION GUIDE

### MAGNETIC TYPE CATHODE RAY TUBES

Type No.	Heater		Bulb							Ion Trap Required	Base	RMA Basin <sup>1</sup>	Waf Filter Capacitance Provided by Bulb Coating	Deflection and Focusing Method	Maximum Design Center Ratings			Typical Operation			Type No.
	Volts	Amps	Nominal Face Dimensions in Inches	Length in Inches	Construction	Terminal	Face Plate Color	Deflection Angle in Degrees (Note 1)	Anode Volts						Accelerator Grid Volts	Anode Volts	Accelerator Grid Volts	Control Grid Negative Volts	Accelerator Grid Volts	Anode Volts	
19BP4	6.3	0.6	18-7/8 Diam.	21-1/2	Glass	Recessed Small Cavity	Clear	66	Double	Small Shell Duodecal 5 Pin	12D2	1000 Min, 3000 Max.	Magnetic	19000	410	13000	250	26-63	19BP4		
19FP4	6.3	0.6	18-7/8 Diam.	22	Glass	Recessed Small Cavity	Gray	66	Double	Small Shell Duodecal 5 Pin	12D1	None	Magnetic	19000	410	13000	250	27-63	19FP4		
19GP4	6.3	0.6	18-7/8 Diam.	21-1/4	Glass	Recessed Small Cavity	Gray	66	Single	Small Shell Duodecal 5 Pin	12D1	None	Magnetic	19000	410	13000	250	27-63	19GP4		
20BP4	6.3	0.6	20 Diam.	28-3/4	Glass	Medium Cap	Clear	54	None	Small Shell Duodecal 7 Pin	12D1	None	Magnetic	16500	750	15000	250	25-70	20BP4		
22AP4	6.3	0.6	21-11/16 Diam.	22-7/8	Metal	(Cone Lip)	Clear	70	Single	Small Shell Duodecal 5 Pin	12D3	None	Magnetic	19000	410	14000	300	33-77	22AP4		
22AP4A							Gray												22AP4A		
904	2.5	2.1	5-1/16 Diam.	16-1/4	Glass	Cap	Clear	...	None	Medium 6 Pin	6AL	None	Note 4	4600	250	1000	100	34	904		
5WP11	6.3	0.6	5 Diam.	11-7/16	Glass	Recessed Small Cavity	Clear	50	None	Small Shell Duodecal 7 Pin	12C2	100 Min, 500 Max.	Note 2	27000	350	27000	200	42-98	5WP11		
7MP7	6.3	0.6	7-3/16 Diam.	12-1/2	Glass	Recessed Small Cavity	Clear	50	None	Small Shell Duodecal 5 Pin	12D1	None	Magnetic	8000	700	4000	250	27-63	7MP7		
19BP4	6.3	0.6	17 x 13-3/32	21-1/8	Glass	Recessed Small Cavity	Gray	65	Single	Small Shell Duodecal 5 Pin	12D2	1000 Min, 2500 Max.	Magnetic	19000	410	13000	250	26-63	19BP4		
16ZP4	6.3	0.6	15-7/8 Diam.	22-1/4	Glass	Recessed Small Cavity	Gray	52	Single	Small Shell Duodecal 5 Pin	12D2	750 Min, 2000 Max.	Magnetic	16000	410	12000	300	33-77	16ZP4		
16WP4A	6.3	0.6	15-7/8 Diam.	17-3/4	Glass	Recessed Small Cavity	Gray	70	Single	Small Shell Duodecal 5 Pin	12D2	750 Min, 2000 Max.	Magnetic	16000	410	12000	250	27-63	16WP4A		
17AP4	6.3	0.6	15-3/8 x 12-1/4	18-5/8	Glass	Recessed Small Cavity	Gray	65	Single	Small Shell Duodecal 5 Pin	12D2	750 Min, 2000 Max.	Magnetic	16000	410	12000	300	33-77	17AP4		
17BP4	6.3	0.6	15-25/64 x 12-9/64	19-5/8	Glass	Recessed Small Cavity	Clear	65	Single	Small Shell Duodecal 5 Pin	12D2	750 Min, 2000 Max.	Magnetic	16000	410	12000	300	33-77	17BP4		
17FP4A							Gray												17FP4A		
10FP4A	6.3	0.6	10-1/2 Diam.	17-5/8	Glass	Recessed Small Cavity	Gray	54	None	Small Shell Duodecal 5 Pin	12D2	500 Min, 2500 Max.	Magnetic	12000	410	11000	250	27-63	10FP4A		

- Note 1: Horizontal Deflection Angles are given for Rectangular Tubes.
- Note 2: Magnetic Deflection, Electrostatic Focusing.
- Note 3: Electrostatic and Magnetic Deflection, Magnetic Focusing.
- Note 4: Electrostatic and Magnetic Deflection, Electrostatic Focusing.

Courtesy Sylvania Electric Products Inc.

CROSS INDEX OF ARMY VT NUMBERS AND COMMERCIAL NUMBERS

VT NUMBER	COMMERCIAL NUMBER	VT NUMBER	COMMERCIAL NUMBER	VT NUMBER	COMMERCIAL NUMBER
VT-1 . . . . .	WE-203A (obsolete)	VT-53 . . . . .	Canceled (super- seded by VT-42A).	VT-99 . . . . .	6F8G.
VT-2 . . . . .	WE-205B	VT-54 . . . . .	34.	VT-100 . . . . .	807.
VT-3 . . . . .	Obsolete.	VT-55 . . . . .	865.	VT-100A . . . . .	807 Modified.
VT-4A . . . . .	Obsolete.	VT-56 . . . . .	56.	VT-101 . . . . .	837.
VT-4B . . . . .	Commercial 211.	VT-57 . . . . .	57.	VT-102 . . . . .	Canceled.
VT-4C . . . . .	JAN 211.	VT-58 . . . . .	58.	VT-103 . . . . .	6SQ7.
VT-5 . . . . .	WE-215A	VT-59 . . . . .	59.	VT-104 . . . . .	12SQ7.
VT-6 . . . . .	212A (obsolete)	VT-60 . . . . .	850.	VT-105 . . . . .	6SC7.
VT-7 . . . . .	WX-12 (obsolete)	VT-61 . . . . .	801,801A.	VT-106 . . . . .	803.
VT-8 . . . . .	UV-204 (obsolete)	VT-62 . . . . .	46.	VT-107 . . . . .	6V6.
VT-10 . . . . .	Obsolete.	VT-63 . . . . .	800.	VT-107A . . . . .	6V6GT.
VT-11 . . . . .	Obsolete.	VT-64 . . . . .	800.	VT-107B . . . . .	6V6G.
VT-12 . . . . .	Obsolete.	VT-65 . . . . .	6C5.	VT-108 . . . . .	450TH.
VT-13 . . . . .	Obsolete.	VT-65A . . . . .	6C5G.	VT-109 . . . . .	2051.
VT-14 . . . . .	Obsolete.	VT-66 . . . . .	6F6.	VT-111 . . . . .	5BP4/1802P4.
VT-16 . . . . .	Obsolete.	VT-66A . . . . .	6F6G.	VT-112 . . . . .	6AC7/1852.
VT-17 . . . . .	860.	VT-67 . . . . .	30 Special.	VT-114 . . . . .	5T4.
VT-18 . . . . .	Obsolete.	VT-68 . . . . .	6B7.	VT-115 . . . . .	6L6.
VT-19 . . . . .	861.	VT-69 . . . . .	6D6.	VT-115A . . . . .	6L6G.
VT-20 . . . . .	Obsolete.	VT-70 . . . . .	6F7.	VT-116 . . . . .	6SJ7.
VT-21 . . . . .	Obsolete.	VT-72 . . . . .	842.	VT-116A . . . . .	6SJ7GT.
VT-22 . . . . .	204A.	VT-73 . . . . .	843.	VT-116B . . . . .	6SJ7Y.
VT-23 . . . . .	Obsolete.	VT-74 . . . . .	5Z4.	VT-117 . . . . .	6SK7.
VT-24 . . . . .	864.	VT-75 . . . . .	75.	VT-117A . . . . .	6SK7GT.
VT-25 . . . . .	10.	VT-76 . . . . .	76.	VT-118 . . . . .	832.
VT-25A . . . . .	10 Special.	VT-77 . . . . .	77.	VT-119 . . . . .	2X2/879.
VT-26 . . . . .	22.	VT-78 . . . . .	78.	VT-120 . . . . .	954.
VT-27 . . . . .	30.	VT-80 . . . . .	80.	VT-121 . . . . .	955.
VT-28 . . . . .	24, 24A.	VT-83 . . . . .	83.	VT-122 . . . . .	530.
VT-29 . . . . .	27.	VT-84 . . . . .	84/6Z4.	VT-123 . . . . .	RCA A-5586 (super- seded by VT-128).
VT-30 . . . . .	01-A	VT-86 . . . . .	6K7.	VT-124 . . . . .	1A5GT.
VT-31 . . . . .	31.	VT-86A . . . . .	6K7G.	VT-125 . . . . .	1C5GT.
VT-32 . . . . .	Obsolete.	VT-86B . . . . .	6K7GT.	VT-126 . . . . .	6X5.
VT-33 . . . . .	33.	VT-87 . . . . .	6L7.	VT-126A . . . . .	6X5G.
VT-34 . . . . .	207.	VT-87A . . . . .	6L7G.	VT-126B . . . . .	6X5GT.
VT-35 . . . . .	35/51.	VT-88 . . . . .	6R7.	VT-127 . . . . .	Special tube.
VT-36 . . . . .	36.	VT-88A . . . . .	6R7G.	VT-127A . . . . .	Special tube.
VT-37 . . . . .	37.	VT-88B . . . . .	6R7GT.	VT-128 . . . . .	1630 (A-5588).
VT-38 . . . . .	38.	VT-89 . . . . .	89	VT-129 . . . . .	304TL.
VT-39 . . . . .	869.	VT-90 . . . . .	6H6.	VT-130 . . . . .	250TL.
VT-39A . . . . .	869A	VT-90A . . . . .	6H6GT.	VT-131 . . . . .	12SK7.
VT-40 . . . . .	40.	VT-91 . . . . .	6J7.	VT-132 . . . . .	12K8 Special.
VT-41 . . . . .	851.	VT-91A . . . . .	6J7GT.	VT-133 . . . . .	12SR7
VT-42 . . . . .	872.	VT-92 . . . . .	6Q7.	VT-134 . . . . .	12A6.
VT-42A . . . . .	872A (Special fil.).	VT-92A* . . . . .	6Q7G.	VT-135 . . . . .	12J5GT.
VT-43 . . . . .	845.	VT-93 . . . . .	6B8.	VT-135A . . . . .	12J5.
VT-44 . . . . .	32.	VT-93A . . . . .	6B8G.	VT-136 . . . . .	1625.
VT-45 . . . . .	45.	VT-94 . . . . .	6J5.	VT-137 . . . . .	1626.
VT-46 . . . . .	866.	VT-94A . . . . .	6J5G.	VT-138 . . . . .	1629.
VT-46A . . . . .	866A.	VT-94B . . . . .	6J5 Special selec.	VT-139 . . . . .	VR150-30.
VT-47 . . . . .	47.	VT-94C . . . . .	6J5G Special selec.	VT-140* . . . . .	1628.
VT-48 . . . . .	41.	VT-94D . . . . .	6J5GT.	VT-141 . . . . .	531.
VT-49 . . . . .	39/44.	VT-95 . . . . .	2A3.	VT-142 . . . . .	WE-39DY1.
VT-50 . . . . .	50.	VT-96 . . . . .	6N7.	VT-143 . . . . .	805.
VT-51 . . . . .	841.	VT-96B . . . . .	6N7 Special selec.	VT-144 . . . . .	813.
VT-52 . . . . .	45 Special.	VT-97 . . . . .	5W4.		
		VT-98 . . . . .	6U5/6G5.		

\* Indicates VT number has been canceled.

## RECEIVING TUBE SUBSTITUTION GUIDE

VT NUMBER	COMMERCIAL NUMBER	VT NUMBER	COMMERCIAL NUMBER	VT NUMBER	COMMERCIAL NUMBER
VT-145. . . .	5Z3.	VT-185. . . .	3D6/1299.	VT-230. . . .	350A.
VT-146. . . .	1N5GT.	VT-186. . . .	Special tube.	VT-231. . . .	6SN7GT.
VT-147. . . .	1A7GT.	VT-187. . . .	575A.	VT-232. . . .	E-1148.
VT-148. . . .	1D8GT.	VT-188. . . .	7E6.	VT-233. . . .	6SR7.
VT-149. . . .	3A8GT.	VT-189. . . .	7F7.	VT-234. . . .	HY-114B.
VT-150. . . .	6SA7.	VT-190. . . .	7H7.	VT-235. . . .	HY-615
VT-150A. . . .	6SA7GT.	VT-191. . . .	316A.	VT-236. . . .	836.
VT-151. . . .	6A8G.	VT-192. . . .	7A4.	VT-237. . . .	957.
VT-151B. . . .	6A8GT.	VT-193. . . .	7C7.	VT-238. . . .	956.
VT-152. . . .	6K6GT.	VT-194. . . .	7J7.	VT-239. . . .	1LE3.
VT-152A. . . .	6K6G.	VT-195. . . .	1005.	VT-240. . . .	710A.
VT-153. . . .	12C8 Special.	VT-196. . . .	6W5G.	VT-241. . . .	7E5/1201.
VT-154. . . .	814.	VT-197A. . . .	5Y3GT/G.	VT-243. . . .	7C4/1203A.
VT-155. . . .	Special tube.	VT-198A. . . .	6G6G.	VT-244. . . .	5U4G.
VT-156. . . .	Special tube.	VT-199. . . .	6SS7.	VT-245. . . .	2050.
VT-157. . . .	Special tube.	VT-200. . . .	VR-105-30.	VT-246. . . .	918.
VT-158. . . .	Special tube.	VT-201. . . .	25L6.	VT-247. . . .	6AG7.
VT-159. . . .	Special tube.	VT-201C. . . .	25L6GT.	VT-248. . . .	1808P1.
VT-160. . . .	Special tube.	VT-202. . . .	9002.	VT-249. . . .	1006.
VT-161. . . .	12SA7.	VT-203. . . .	9003.	VT-250. . . .	EF50.
VT-162. . . .	12SJ7.	VT-204. . . .	HK24G.	VT-251. . . .	441.
VT-163. . . .	6C8G.	VT-205. . . .	6ST7.	VT-252. . . .	923.
VT-164. . . .	1619.	VT-206A. . . .	5V4G.	VT-254. . . .	304TH.
VT-165. . . .	1624.	VT-207. . . .	12AH7GT.	VT-255. . . .	705A.
VT-166. . . .	371A.	VT-208. . . .	7B8.	VT-256. . . .	ZP486.
VT-167. . . .	6K8.	VT-209. . . .	12SG7.	VT-257. . . .	K-7.
VT-167A. . . .	6K8G.	VT-210. . . .	1S4.	VT-259. . . .	829.
VT-168A. . . .	6Y6G.	VT-211. . . .	6SG7.	VT-260. . . .	VR75-30.
VT-169. . . .	12C8.	VT-212. . . .	958.	VT-264. . . .	3Q4.
VT-170. . . .	1E5-GP.	VT-213A. . . .	6L5G.	VT-266. . . .	1616.
VT-171. . . .	1R5.	VT-214. . . .	12H6.	VT-267. . . .	578.
VT-171A. . . .	Loctal Equiv. of 1R5.	VT-215. . . .	6E5.	VT-268. . . .	12SC7.
VT-172. . . .	1S5.	VT-216. . . .	816.	VT-269. . . .	717A.
VT-173. . . .	1T4.	VT-217. . . .	811.	VT-277. . . .	417.
VT-174. . . .	3S4.	VT-218. . . .	100TH.	VT-279. . . .	GY-2.
VT-175. . . .	1613.	VT-219. . . .	Canceled.	VT-280* . . . .	C7063.
VT-176. . . .	6AB7/1853.	VT-220. . . .	250TH.	VT-281* . . . .	HY-145ZT.
VT-177. . . .	1LH4.	VT-221. . . .	3Q5GT.	VT-282. . . .	ZG489.
VT-178. . . .	1LC6.	VT-222. . . .	884.	VT-283* . . . .	QF-206.
VT-179. . . .	1LN5.	VT-223. . . .	1H5GT.	VT-284* . . . .	QF-197.
VT-180* . . . .	3LF4.	VT-224. . . .	RK-34.	VT-285* . . . .	QF-200C.
VT-181. . . .	7Z4.	VT-225. . . .	307A.	VT-286. . . .	832A.
VT-182. . . .	3B7/1291.	VT-226. . . .	3EP1/1806P1.	VT-287. . . .	815.
VT-183. . . .	1R4/1294.	VT-227. . . .	7184.	VT-288. . . .	12SH7.
VT-184. . . .	VR90-30.	VT-228. . . .	8012.	VT-289. . . .	12SL7GT.
		VT-229. . . .	6SL7GT.		

\* Indicates VT number has been canceled.

BALLAST TUBE AND RESISTOR NUMBERING CODES  
FOR AC-DC RECEIVERS USING 0.3 AMP. SERIES CONNECTED HEATERS

There are two numbering codes now in use for ballast and resistor tubes. Both codes use parts of the type designation to indicate the various divisions of the tube's service. For example, type numbers in the first system (A) might be BKX51DJ or L55B and, in the second system (B), might be 200R44 or 200R. These letter and number combinations are explained by the following examples.

SYSTEM A

BKY49CJG

- The letter G, if present, indicates that the tube has a glass bulb and octal base.
- The letter J, if present, indicates that a jumper is located between pins 3 and 4.
- Letters A to K here indicate the internal circuit connections. (See adjacent figures.)
- This number gives the voltage drop with 0.3 ampere. (See Note 4.)
- The letters X, Y, or Z, if present, indicate the style of base and the pin connections. (See Note 3.)
- The letters K, L, or M indicate the type of pilot lamp that must be used with this tube. (See Note 2.)
- The letter B, when present, indicates that the pilot-lamp shunt-resistor is a ballast type. (See Note 1.)

NOTE 1.

"Ballast" action indicates that the pilot lamp shunt resistor has low starting resistance when cold, protecting the lamp filament from the initial current surge, and has much higher resistance when hot, applying full operating voltage to the lamp.

NOTE 2.

Tube Letter	Lamp No.	Volts	Amperes	Bead Color
K	40 and 47	6.3	0.15	Brown
L	44 and 46	6.3	0.25	Blue
M	50 and 51	7.5	0.2	White

NOTE 3.

X denotes a 4 pin base and metal shell. Y or Z denote octal bases but with different pin connections. (See Figures A to K.)

NOTE 4.

This number includes the drop in the series resistor plus the drop in the pilot lamp and its shunt. The number represents the difference between the sum of the heater voltages and the line voltage of 117.5 volts. Tubes are made with the following numbers: 98, 92, 86, 80, 73, 67, 61, 55, 49, 42, 36, 30, 23, 17, 11. The number to be used is the one closest to the voltage difference mentioned above.

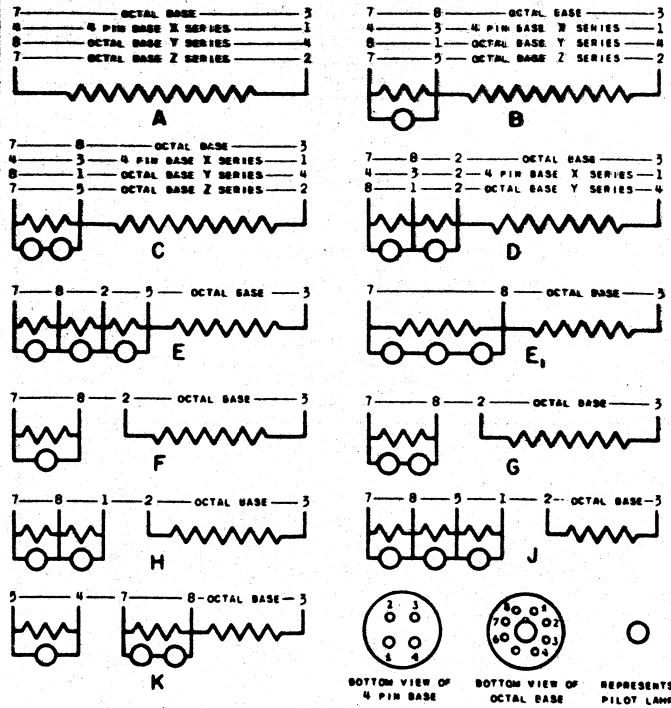

SYSTEM B

All tubes under System B have glass bulbs and 4 pin bases and their type designations start with a number.

EXAMPLE

200R44

- The numbers 4, 8, or 44, in combination with the preceding letter, indicate the internal tube connections. (See below.)
- The letters R, L, or M, when followed by a number, indicate the type of pilot lamp which must be used with this tube. See Note 2, using the letter R in place of K. (The letter R, alone, indicates only a form of internal tube connection without pilot lamp.)
- This number indicates the equivalent resistance in ohms at 0.3 ampere. Thus,  $200 \times 0.3 = 60$  volts drop.

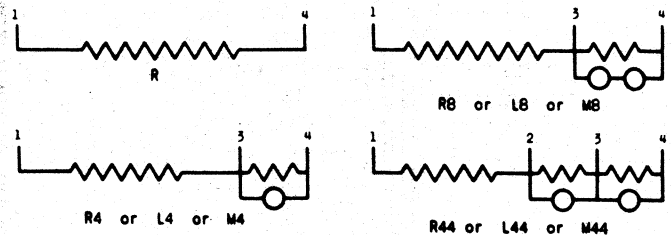

Courtesy TUNG-SOL Lamp Works, Inc.

RTMA CAPACITOR, RESISTOR, AND TRANSFORMER COLOR CODES

CAPACITOR COLOR CODE

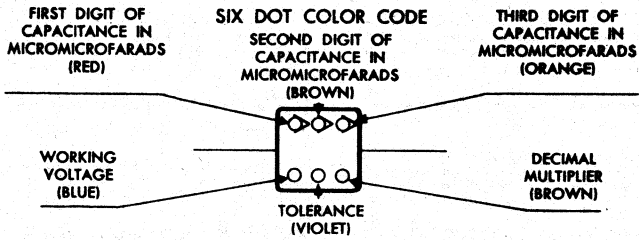

EXAMPLE: 2130  $\mu\mu\text{f.} \pm 7\%$ , 600 W.V. (Values for color shown in the above parenthesis)

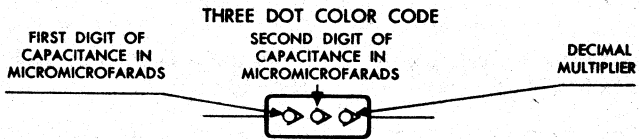

COLOR	DIGIT NUMERAL	DECIMAL MULTIPLIER	TOLERANCE	WORKING VOLTAGE
BLACK	0	1	20%	—
BROWN	1	10	1%	100
RED	2	100	2%	200
ORANGE	3	1000	3%	300
YELLOW	4	10000	4%	400
GREEN	5	—	5%	500
BLUE	6	—	6%	600
VIOLET	7	—	7%	700
GRAY	8	—	8%	800
WHITE	9	—	9%	900
GOLD	—	0.1	—	1000
SILVER	—	0.01	10%	—

POWER TRANSFORMER LEAD COLOR CODE

Power transformer leads in radio receivers may be identified by the following colors (or color patterns) on the lead coverings.

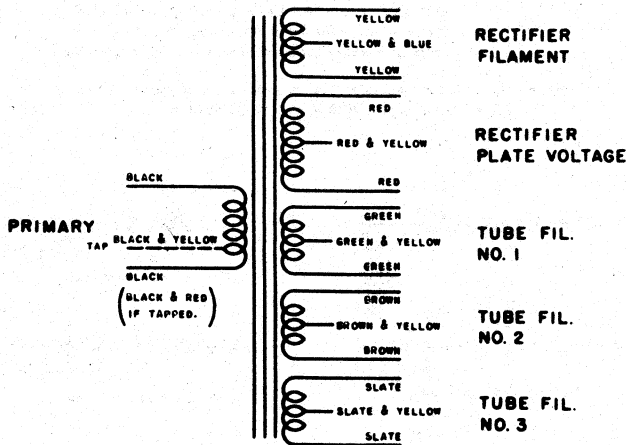

Courtesy TUNG-SOL Lamp Works, Inc.

RESISTOR COLOR CODE

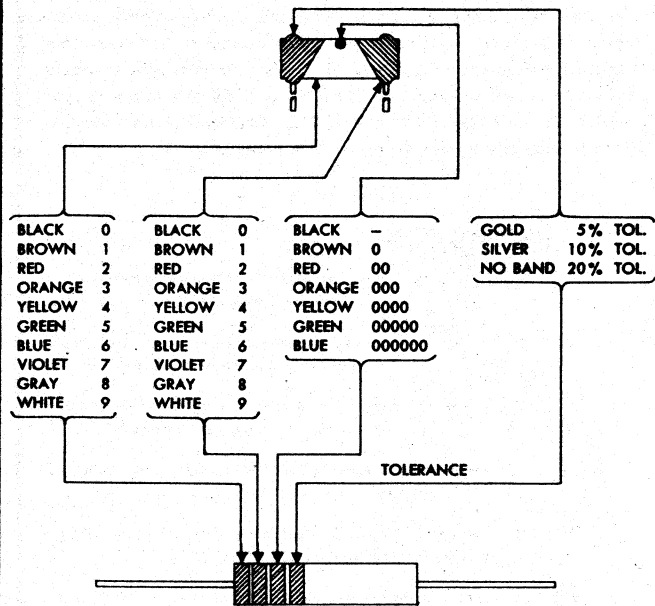

BLACK	0	BLACK	0	BLACK	—	GOLD	5% TOL.
BROWN	1	BROWN	1	BROWN	0	SILVER	10% TOL.
RED	2	RED	2	RED	00	NO BAND	20% TOL.
ORANGE	3	ORANGE	3	ORANGE	000		
YELLOW	4	YELLOW	4	YELLOW	0000		
GREEN	5	GREEN	5	GREEN	00000		
BLUE	6	BLUE	6	BLUE	000000		
VIOLET	7	VIOLET	7				
GRAY	8	GRAY	8				
WHITE	9	WHITE	9				

RESISTANCE VALUE: The nominal resistance value in ohms is identified by a three digit symbol. The first two digits are the first two figures of the resistance value in ohms. The third digit specifies the number of zeros which follow the first two figures.

I-F TRANSFORMER LEAD COLOR CODE

I-F transformer leads in radio receivers may be identified by the following colors on the lead coverings.

PLATE LEAD BLUE GRID (or diode lead) GREEN  
B+ LEAD RED GRID RETURN BLACK

FOR "FULL-WAVE" TRANSFORMER SECOND DIODE LEAD WILL BE GREEN-BLACK.

AUDIO TRANSFORMER LEAD COLOR CODE

Interstage and Output Audio Transformer leads in radio receivers may be identified by the colors on the lead coverings as shown.

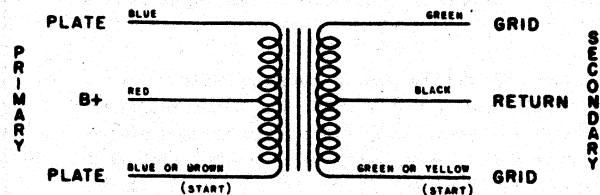

In cases where use is made of a single primary and/or a single secondary, the upper half of the diagram indicates the color coding. The brown and yellow leads indicate the start of the primary and secondary windings respectively and will be used in place of the blue and green (as shown) where polarity indications are required.

## RECEIVING TUBE SUBSTITUTION GUIDE

PILOT LAMP TABLE

Lamp No.	Volts	Amperes	Bead Color	Miniature Base	Bulb Type
40	6-8	0.15	Brown	Screw	T-3 1/4
41	2.5	0.50	White	Screw	T-3 1/4
42	3.2	0.35	Green	Screw	T-3 1/4
43	2.5	0.50	White	Bayonet	T-3 1/4
44	6-8	0.25	Blue	Bayonet	T-3 1/4
45	3.2	0.35	White	Bayonet	T-3 1/4
46	6-8	0.25	Blue	Screw	T-3 1/4
47	6-8	0.15	Brown	Bayonet	T-3 1/4
48	2.0	0.06	Pink	Screw	T-3 1/4
49	2.0	0.06	Pink	Bayonet	T-3 1/4
50	6-8	0.20	White	Screw	G-3 1/2
51	6-8	0.20	White	Bayonet	G-3 1/2
55	6-8	0.40	White	Bayonet	G-4 1/2
292	2.9	0.17	White	Screw	T-3 1/4
292A	2.9	0.17	White	Bayonet	T-3 1/4
1455	18.0	0.25	Brown	Screw	G-5
1455A	18.0	0.25	Brown	Bayonet	G-5
1490	3.2	0.16	- - -	Bayonet	T-3 1/4

GERMANIUM CRYSTAL DIODE CHARACTERISTICS

Germanium Crystal	Min. Forward Current at +1v (Ma)	Max. Reverse Current (Microamp.)	Peak Inverse Voltage (Volts)	Average Anode Rect. Current (Ma)	Peak Anode Rect. Current (Ma)
1N34	5.0	50 at -10v	75	40	150
1N34A		800 at -50v			
1N35*	7.5	10 at -3v	75	22.5	60
1N38	3.0	6 at -3v	120	40	150
1N38A		625 at -100v			
1N39	3.0	200 at -100v 800 at -200v	225	40	150
1N40**	12.75 {(at 1.5 volts)}	50 at -10v	75	22.5	60
1N41**	12.75 {(at 1.5 volts)}	50 at -10v	75	22.5	60
1N42**	12.75 {(at 1.5 volts)}	6 at -3v 625 at -100v	120	22.5	60
1N48	4.0	833 at -50v	85	50	150
1N51	2.5	1670 at -50v	50	25	100
1N52	4.0	150 at -50v	85	50	150
1N54	5.0	10 at -10v	75	40	150
1N54A					
1N55	3.0	300 at -100v	170	40	150
1N55A		800 at -150v			
1N56	15.0	300 at -30v	50	50	200
1N56A					
1N57	4.0	500 at -75v	90	40	150
1N58	4.0	800 at -100v	115	40	150
1N58A					
1N60†	†	†	70	40	150
1N63	4.0	50 at -50v	125	50	150
1N64	Tested for efficiency in 44 Mc video detector circuit.				
1N65	2.5	250 at -50v	85	50	150
1N69†	5.0	850 at -50v	75	40	125
1N70*	3.0	410 at -50v	125	30	90
1N71††	15.0	300 at -30v	50	50	200

NOTE: Crystals 1N48, 1N51, 1N52, 1N63, 1N64, and 1N65 are General Electric types, all others are Sylvania types unless otherwise indicated.

\* Units are matched in the forward direction at +1 volt so that the current flowing through the higher resistance unit is within 10% of that in the lower resistance unit. Ratings shown are for each diode.

\*\* Consists of 4 specially selected and matched germanium diodes whose resistances are balanced within  $\pm 2.5\%$  in the forward direction at 1.5 volts. For additional balance, the forward resistance of each pair of varistor crystals are matched within 3 ohms. Ratings shown above are for each diode.

† Units are tested in a circuit employing an input of 1.8 volts rms at 40 mc. 70% modulated at 400 cycles. Demodulated output across a 4700 ohm resistor shunted by a 5 mmf capacitor is a minimum of 1.1 volts peak to peak.

† JAN types

†† Consists of four matched low impedance germanium diodes each of which, with a voltage of one volt impressed in the forward direction, will pass a current within one ma of the average current of the four. Ratings shown above are for each diode.



# ADV Plans, LLC

## Copyright Notice:

The entire contents of this CD/DVD are copyright 2014 by ADV Plans, LLC. All Rights Reserved.

Reproduction or distribution of this disk, either free or for a fee is strictly prohibited. We actively monitor and remove listings on eBay thru Vero.

You are free to copy or use individual images in your own projects, magazines, brochures or other school projects.

Only the sellers listed here are authorized distributors of this collection:  
[www.theclassicarchives.com/authorizedsuppliers](http://www.theclassicarchives.com/authorizedsuppliers)

Please view our other products at  
[www.theclassicarchives.com](http://www.theclassicarchives.com),  
or our ebay stores:

[TheClassicArchives](#)  
[ADVPlans](#)  
[SuperShedPlans](#)

